

Technical description

MULTICAL® 603



List of words and symbols

Word/symbol	Meaning	Unit	Expired designations
qi	Minimum approved flow	[l/h]	Q _i , q _{vmin} , Q _{min} , q _{min}
qp	Permanent/approved nominal flow	[m ³ /h]	Q _s , q _{vmax} , Q _n , q _n , q _{max}
qs	Maximum approved flow ¹	[m ³ /h]	Q _{max}
Θ	Temperature range of calculator	[°C]	
Θ _q	Temperature range of flow sensor (medium)	[°C]	
Θ _{hc}	Limit value for shift between heat and cooling ²	[°C]	
ΔΘ	Temperature difference of inlet and outlet	[K]	
Δflow	Difference in actual flow between V1 and V2	[m ³ /h]	
ΔMass	Difference in mass between M1 and M2	[kg]	
t _{BAT}	Battery temperature	[°C]	
DN	Nominal diameter	[mm]	
PN	Nominal pressure	[bar]	
E _c	Max permissible error of calculator	[%]	
E _f	Max permissible error of flow sensor	[%]	
E _t	Max permissible error of temperature sensors	[%]	
MPE	Maximum permissible error	[%]	
PQ	Power and flow in connection with tariff		
GF	Glass fibre reinforcement		
KMP	Kamstrup Meter Protocol		
CP	Coefficient of Performance (COP)		

¹ Less than an hour/day and less than 200 hours/year

² Only available in meter type 6

Contents

1	General description	8
1.1	Mechanical construction.....	9
1.2	Electronic structure.....	10
2	Technical data	11
2.1	Approved meter data.....	11
2.2	Accuracy.....	12
2.3	Accuracy of a complete meter	12
2.4	Electrical data.....	13
2.5	Mechanical data.....	17
2.6	Materials	17
3	Type overview	18
3.1	Type number.....	19
3.1.1	Accessories	21
3.2	Configuration number.....	24
3.2.1	Flow sensor position >A<.....	25
3.2.2	Measuring unit >B<.....	25
3.2.3	Flow sensor coding >CCC<	26
3.2.4	Display code >DDD<.....	33
3.2.5	Tariffs >EE<	37
3.2.6	Pulse inputs A and B >FF-GG<.....	43
3.2.7	Integration mode >L<	47
3.2.8	Leakage limits (V1, V2) >M<.....	52
3.2.9	Cold water leakage (In-A, In-B) >N<.....	53
3.2.10	Pulse outputs C and D >PP<.....	53
3.2.11	Data logger profile >RR<	57
3.2.12	Encryption level >T<.....	60
3.2.13	Customer label >VVV<	60
3.3	Data.....	61
3.3.1	Serial number and extended availability.....	63
3.3.2	Target date.....	64
4	Installation.....	65
4.1	Installation requirements.....	65
4.2	Mounting of MULTICAL® 603 calculator	66
4.2.1	Compact mounting	66
4.2.2	Wall mounting	66
4.3	Mounting in inlet or outlet.....	67

MULTICAL® 603

4.4	EMC conditions.....	67
4.5	Climatic conditions	68
4.6	Sealing	68
5	Dimensional sketches	69
6	Display	71
6.1	"USER loop"	75
6.2	"TECH loop"	75
6.2.1	Module readings	81
6.3	"SETUP loop"	82
6.3.1	Change of parameters in the "SETUP loop"	83
6.4	"TEST loop"	91
6.5	Registers and resolution	92
7	Calculator functions.....	93
7.1	Application types and energy calculations	93
7.1.1	Approvals for energy and applications	94
7.1.2	Components used in applications	94
7.1.3	Application drawings	95
7.1.4	Energy calculations and registers E1 and E3	101
7.1.5	Energy calculations and registers E8, E9, E10 and E11.....	104
7.1.6	Outlet energy registers A1 and A2	105
7.2	Measurement of a heat pump's coefficient of performance.....	106
7.2.1	Coefficient of Performance (CP).....	106
7.2.2	Seasonal Coefficient of Performance (SCOP)	107
7.2.3	Measurement of the coefficient of performance (CP) of a gas boiler	107
7.3	Offset adjustment of temperature sensor measurement	108
7.4	Bifunctional heat/cooling metering.....	109
7.5	Min/max calculations of power (P) and flow (Q)	110
7.6	Temperature measurement	112
7.7	Information code types	113
7.7.1	Information code types in display	114
7.7.2	Information code types on serial communication.....	117
7.8	Transport state	118
7.9	Info logger	119
7.10	Config data logger	119
7.11	Summer/winter time adjustment.....	120
7.12	Preset and Scheduler functions for temperature inputs	121
7.13	Differential energy and volume calculation.....	121

8	Flow sensor connection	123
8.1	ULTRAFLOW® (Connection type 1-2-7-8).....	123
8.1.1	Auto Detect of ULTRAFLOW® X4.....	124
8.1.2	The need for longer cables between MULTICAL® 603 and ULTRAFLOW®	126
8.2	Flow sensor with reed or relay switch output (Connection type L).....	127
8.3	Flow sensor with transistor output (Connection type 7-8-C-J).....	127
8.4	Flow sensors with active 24 V pulse output (Connection type P)	127
8.4.1	Connection examples.....	128
8.5	MULTICAL® with V1 and V2 of different sizes	129
8.6	Connect more calculators to one flow sensor.....	133
9	Temperature sensors.....	135
9.1	Cable influence and connection of cables.....	135
9.2	Sensor types.....	137
9.3	Pt500 direct short temperature sensor set.....	138
9.4	Pt500 ø5.0 mm / ø5.2 mm temperature sensors.....	139
9.5	Pt500 ø5.8 mm / ø6.0 mm pocket sensor set	141
9.6	Identification of inlet and outlet temperature sensor.....	142
9.7	TemperatureSensor 83 – ø5.8 mm pocket sensor with connection head	142
9.8	TemperatureSensor SP 4-wire – ø6 mm EN1434 pocket sensor with connection head	144
9.9	Installation of 4 temperature sensors in large pipes	145
9.10	Resistance tables.....	146
10	Power supply.....	147
10.1	Lithium battery, 2 x A-cells	147
10.2	Lithium battery, 1 x D-cell	148
10.3	Lithium battery, 1 x D-cell IoT	148
10.4	Battery lifetimes.....	149
10.5	230 VAC supply module	152
10.6	24 VAC supply module	152
10.7	230 VAC high-power SMPS.....	153
10.8	24 VDC/VAC high-power SMPS	153
10.9	Power consumption of mains connected meter	154
10.10	Transformer 230/24 VAC	154
10.11	Supply cables for supply module.....	154
10.12	Retrofitting and exchange of supply modules.....	155
10.13	Data backup in case of interruption of supply.....	156

11 Communication..... 157

- 11.1 Integrated M-Bus..... 157
- 11.2 Communication modules..... 158
- 11.3 Marking on communication modules..... 159
- 11.4 Modules..... 160
 - 11.4.1 HC-003-10: Data Pulse, inputs (In-A, In-B) 160
 - 11.4.2 HC-003-11: Data Pulse, outputs (Out-C, Out-D)..... 160
 - 11.4.3 HC-003-20: Wired M-Bus, inputs (In-A, In-B) 161
 - 11.4.4 HC-003-21: Wired M-Bus, outputs (Out-C, Out-D)..... 161
 - 11.4.5 HC-003-22: Wired M-Bus, Thermal Disconnect 161
 - 11.4.6 HC-003-30: Wireless M-Bus, inputs (In-A, In-B), 868 Mhz..... 162
 - 11.4.7 HC-003-31: Wireless M-Bus, outputs (Out-C, Out-D), 868 Mhz..... 162
 - 11.4.8 HC-003-32: linkIQ/wM-Bus, inputs (In-A, In-B), EU 163
 - 11.4.9 HC-003-33: linkIQ/wM-Bus, outputs (Out-C, Out-D),EU..... 163
 - 11.4.11 HC-003-40: Analog outputs 2 x 0/4...20 mA 164
 - 11.4.12 HC-003-41: Analog inputs 2 x 4...20 mA / 0...10 V 164
 - 11.4.13 HC-003-43: PQT Controller 164
 - 11.4.14 HC-003-50: Low Power Radio, inputs (In-A, In-B), 434 MHz, 434 MHz..... 165
 - 11.4.15 HC-003-51: Low Power Radio GDPR, inputs (In-A, In-B), 434 MHz..... 165
 - 11.4.16 HC-003-56: NB-IoT, inputs (In-A, In-B)..... 165
 - 11.4.17 HC-003-58: NB-IoT (Elvaco) 166
 - 11.4.18 HC-003-60: LON TP/FT-10, inputs (In-A, In-B)..... 166
 - 11.4.19 HC-003-66: BACnet MS/TP, inputs (In-A, In-B) 166
 - 11.4.20 HC-003-67: Modbus RTU, inputs (In-A, In-B) 167
 - 11.4.21 HC-003-80: 2G/4G Network, inputs (In-A, In-B)..... 167
 - 11.4.23 HC-003-82: Modbus/KMP TCP/IP, inputs (In-A, In-B) 167
 - 11.4.24 HC-003-83: REAdy Ethernet, inputs (In-A, In-B) 168
 - 11.4.25 HC-003-84: High Power Radio Router, inputs (In-A, In-B), 444 MHz 168
 - 11.4.26 HC-003-85: High Power Radio Router GDPR, inputs (In-A, In-B), 444 MHz 168
- 11.5 Reading high resolution registers 169
- 11.6 Mounting of antenna..... 169
- 11.7 Module retrofitting..... 170
- 11.8 Supply of modules 171

12	Data communication	172
12.1	MULTICAL® 603 data protocol	172
12.2	Optical readout head	172
12.3	Data protocol	172
13	Mixed fluid	173
13.1	Type number	173
13.2	Configuration number	175
13.3	Tariffs	176
13.4	Volume weighted average temperatures	176
14	Test and calibration	177
15	Approvals	180
15.1	Type approvals	180
15.2	The Measuring Instruments Directive	180
16	Troubleshooting	181
17	Disposal	182
18	Documents	183

1 General description

MULTICAL® 603 is an all-round calculator, suitable as heat meter, cooling meter or combined heat/cooling meter together with 1 or 2 flow sensors and 2 or 3 temperature sensors. The meter is intended for energy measurement in almost all types of thermal installations where water is used as the energy-conveying medium.

MULTICAL® 603 can, in addition to heat and cooling measurement, be used for leakage monitoring, permanent performance monitoring, as power and flow limiter with valve control as well as for energy measurement in both open and closed systems.

The MULTICAL® 603 calculator variant "M" (Mixed fluid) can operate in sub-zero temperatures, with a temperature range of -40...+140 °C. In applications where sub-zero temperatures can be expected it is important to select temperature sensors and flow sensor with a suitable temperature range. Mixed fluids have a lower specific heat capacity compared to that of water. Kamstrup mixed fluid calculator variant can compensate for this and thereby provide precise measurements regardless of the chemical composition in the installation.

According to EN 1434 and MID, MULTICAL® 603 can be designated as a "calculator" with separate type approval and verification, and it can be delivered either as a separate calculator or as a complete meter, with mounted temperature sensors and flow sensors according to customer requirements.

The MULTICAL® 603 calculator top can be separated from the connection base without using tools when the installation seals are broken. This provides free access to the installation of the flow sensor, temperature sensors, power supply/battery and communication modules.

The calculator top is factory-sealed and may only be opened by authorised meter laboratories. If the factory seal is broken, the factory guarantee no longer applies.

MULTICAL® 603 has 2 flow sensor inputs that can be used for both electronic and mechanical flow sensors. The pulse figure can be programmed from 0,001 to 300 pulses/liter, and the calculator can be programmed to all nominal flow sensor sizes from 0,6 to 15.000 m³/h. The calculator can be delivered with both galvanically connected and separated flow sensor inputs.

The temperature measurements in inlet and outlet are performed with accurately paired Pt500 or Pt100 sensor according to EN 60 751 and EN 1434. MULTICAL® 603 normally comes with a Pt500 sensor pair, e.g. short direct sensors according to EN 1434-2 or ø5,8 mm pocket sensors, which fit Kamstrup sensor pockets in stainless steel. MULTICAL® 603 can also be delivered with 4-wire temperature sensor inputs that are especially suitable for installations with long temperature sensor cables.

Accumulated heat energy and/or cooling energy can be displayed in kWh, MWh, GJ or Gcal, all with seven or eight significant digits plus measuring unit. The display has been specially designed with a view to obtaining long lifetime and sharp contrast in a wide temperature range. Furthermore, MULTICAL® 603 can be delivered in a variant with backlit display (type 603-F).

Other reading options are: accumulated water consumption, operating hour counter, error hour counter, current temperature measurements, actual flow and power readings. Furthermore, MULTICAL® 603 can be configured to display monthly and yearly loggings, target date data, max/min. flow, max/min. power, information code, current date as well as user-defined tariffing.

MULTICAL® 603 is powered by an internal D-cell lithium battery with a lifespan up to 16 years or a 2xA lithium batteries with a lifespan of up to 9 years. Alternatively, the meter can be mains supplied, either by 24 VAC or 230 VAC.

In addition to the energy meter's own data, MULTICAL® 603 can display the accumulated consumptions of two extra water meters, e.g. cold and hot water meters, which supply a pulse signal to MULTICAL® 603 via reed-switch or electronic output. The contact signals from the extra water meters are connected via the communication modules.

A multiple plug placed behind the seal is used in connection with calibration and adjustment during verification as well as in connection with communication modules. MULTICAL® 603 is available with 1 or 2 communication modules

for, among other things, Wireless M-Bus, M-Bus and RS232. The modules are available with either pulse inputs or pulse outputs. Furthermore, the meter can be delivered with integrated M-Bus, independent of the modules.

In designing MULTICAL® 603, great importance has been attached to flexibility through programmable functions and plug-in modules (see paragraphs 3.2 and 11) in order to secure optimum use in a wide range of applications. In addition, the construction makes it possible to update previously installed MULTICAL® 603 via the PC-program METERTOOL HCW.

This technical description has been written with a view to enabling operations managers, meter installers, consulting engineers and distributors to utilize all functions comprised in MULTICAL® 603. Furthermore, the description is targeted at laboratories performing tests and verification.

The technical description is currently updated. Find the latest edition at www.kamstrup.com/en-en/product-centre

1.1 Mechanical construction

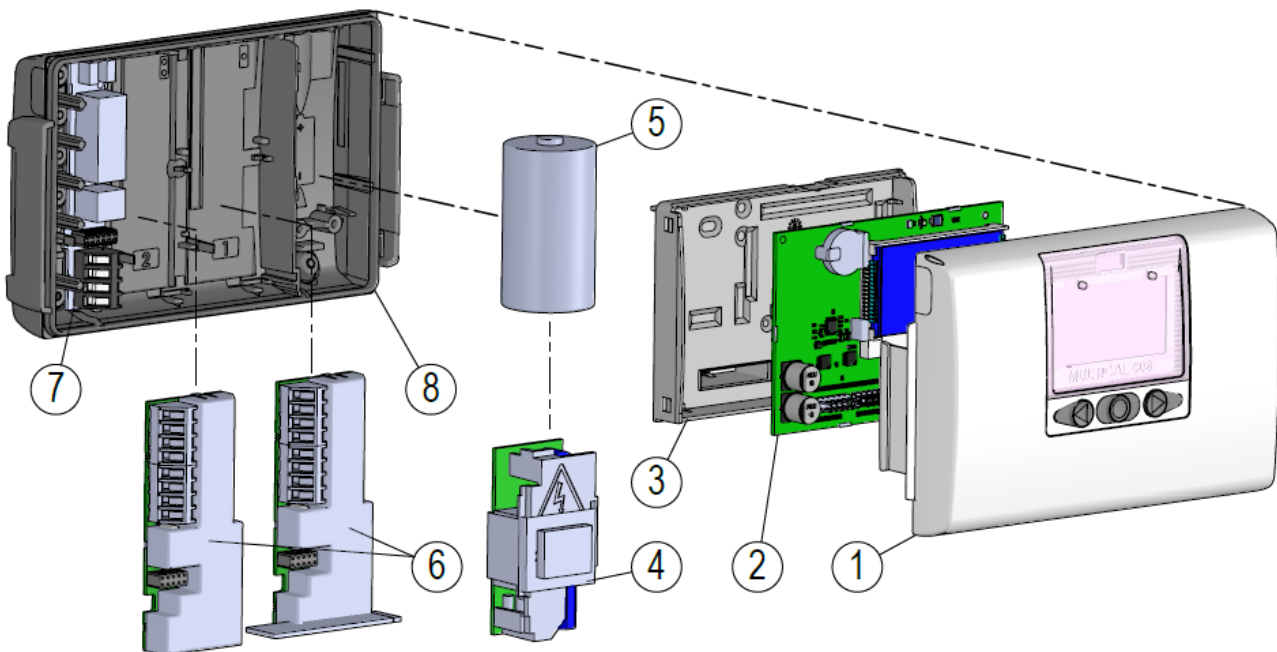

Figure 1

1	Top cover with front keys and laser engraving
2	PCB with microcontroller, display, etc.
3	Verification cover (may only be opened by an authorised laboratory)
4	Either a power supply module can be mounted...

5	... or a battery can be mounted
6	1 or 2 communication modules
7	Connection of temperature sensors and flow sensor
8	Bottom cover

1.2 Electronic structure

The electronic construction of MULTICAL® 603 is shown in the below block diagram. 1 or 2 of the described modules, which include pulse inputs or pulse outputs in addition to data communication, can be mounted in the module bays of MULTICAL® 603. During operation MULTICAL® 603 only includes one of the seven supply module types.

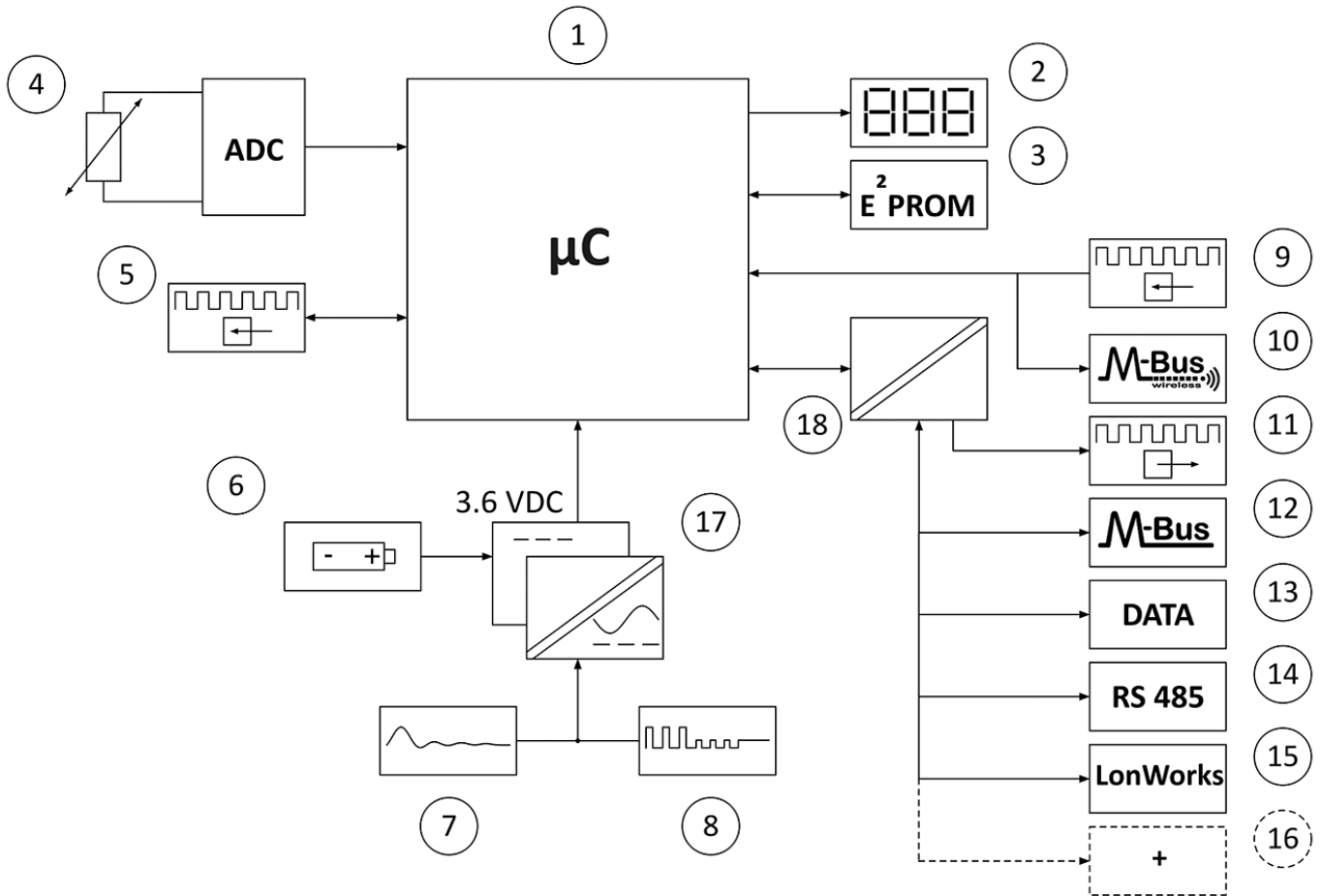

1	Microcontroller
2	Display, eight-digit seven-segment + symbols
3	Non-volatile memory, E²PROM
4	Temperature sensors, Pt100 or Pt500, 2- or 4-wire
5	Pulse input(s) for flow sensor(s)
6	Battery, 2 x A-cells, 1 x D-cell or 1 x D-cell IoT
7	Linear power supply, 24 VAC or 230 VAC
8	High-power SMPS, 24 VAC/VDC or 230 VAC
9	Pulse inputs

10	Wireless M-Bus
11	Pulse outputs
12	M-Bus
13	Data communication
14	RS485, Modbus and BACnet
15	LonWorks
16	... and even more communication possibilities
17	Galvanic separation, power supplies
18	Galvanic separation, communication modules

Note: The arrows in the figure indicate the signal direction.

2 Technical data

2.1 Approved meter data

Approvals	DK-0200-MI004-040, heat meter According to MID 2014/32 EU, EN 1434:2007/AC:2007, EN 1434:2015 + A1:2018, FprEN 1434:2022 from 2022-04 and WELMEC 7.2:2021
	TS 27.02 012, cooling meter and cooling/heat meter According to DK-BEK 1178 , EN 1434:2007/AC:2007, EN 1434:2015 + A1:2018 and FprEN 1434:2022 from 2022-04
EU directives	Measuring Instruments Directive, Low Voltage Directive, Electromagnetic Compatibility Directive, Pressurized Equipment Directive, Radio Equipment Directive, RoHS Directive

Heat meter approval	DK-0200-MI004-040	
Temperature range	θ : 2 °C...180 °C	The stated minimum temperatures are related to the type approval.
Differential range	$\Delta\theta$: 3 K...178 K	
Cooling meter and cooling/heat meter	TS 27.02 012	The meter has no cut-off for low temperature and thus measures down to 0,01 °C and 0,01 K.
Temperature range	θ : 2 °C...180 °C	
Differential range	$\Delta\theta$: 3 K...178 K	
Differential range, cut-off	0,00...2,50 K	
Media temperature, ULTRAFLOW®	θ_q : 2 °C...130 °C	
Accuracy		
- Calculator	$E_c = \pm (0,5 + \Delta\theta_{\min}/\Delta\theta) \%$	
- Flow sensor, ULTRAFLOW®	$E_f = \pm (2 + 0,02 qp/q)$, but not exceeding $\pm 5 \%$	
Temperature sensor connection	Type 603-A Pt100 – EN 60 751, 2-wire connection Type 603-B Pt100 – EN 60 751, 4-wire connection Type 603-C/E/F/M Pt500 – EN 60 751, 2-wire connection Type 603-D/G/H Pt500 – EN 60 751, 4-wire connection	
EN 1434 designation	Environmental class A and C	
MID designation	Mechanical environment: Class M1 and M2 Electromagnetic environment: Class E1 and E2 Non-condensing environment, closed location (indoors), 5...55°C Condensing environment, closed location (indoors), 5...55°C	

2.2 Accuracy

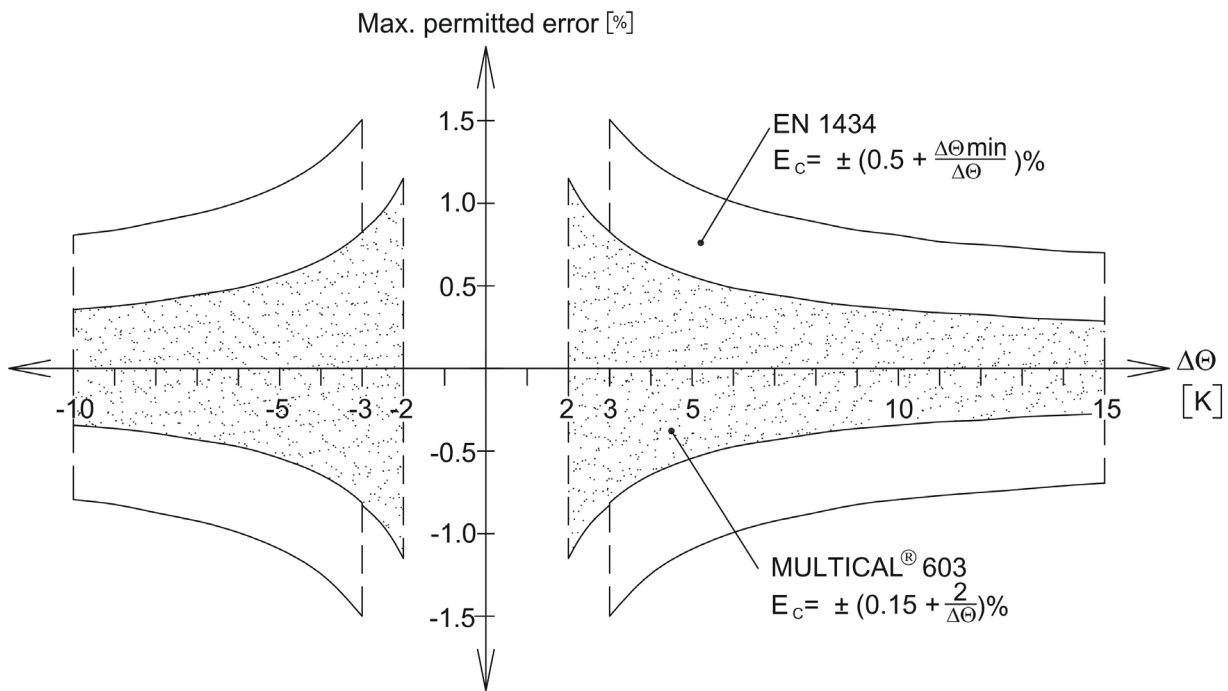

Figure 2: Typical accuracy of MULTICAL® 603 compared to EN 1434.

2.3 Accuracy of a complete meter

Heat meter components	MPE according to EN 1434-1	Typical accuracy
ULTRAFLOW®	$E_f = \pm (2 + 0,02 qp/q)$, but not exceeding $\pm 5 \%$	$E_f = \pm (1 + 0,01 qp/q) \%$
MULTICAL® 603	$E_c = \pm (0,5 + \Delta\Theta_{\min}/\Delta\Theta) \%$	$E_c = \pm (0,15 + 2/\Delta\Theta) \%$
Sensor pair	$E_t = \pm (0,5 + 3 \Delta\Theta_{\min}/\Delta\Theta) \%$	$E_t = \pm (0,4 + 4/\Delta\Theta) \%$

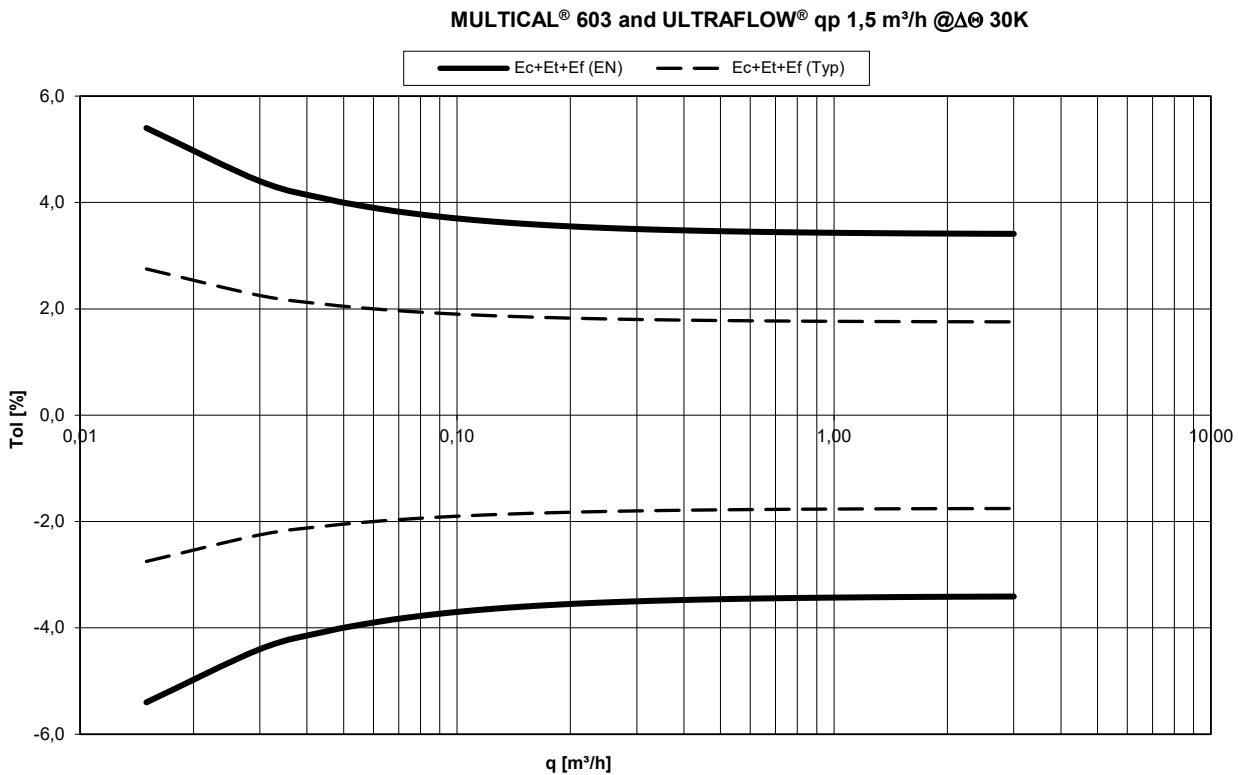

Diagram 1: Total typical accuracy of MULTICAL® 603, sensor pair and ULTRAFLOW® compared to EN 1434-1

2.4 Electrical data

Calculator data

Typical accuracy	Calculator: $E_c \pm (0,15 + 2/\Delta\Theta) \%$	Sensor pair: $E_t \pm (0,4 + 4/\Delta\Theta) \%$
Display	LCD – 7 or 8 digits, digit height 8,2 mm	
Resolutions	999,9999 – 9999,999 – 99999,99 – 999999,9 – 9999999 9999,9999 – 99999,999 – 999999,99 – 9999999,9 – 99999999	
Energy units	MWh – kWh – GJ – Gcal	
Data logger (EEPROM), programmable	Logging intervals: From one minute to one year Logger content: All registers can be selected Standard logger profile: 20 years, 36 months, 460 days, 1400 hours (RR-code = 10)	
Info logger (EEPROM)	250 info codes can be read via LogView, the last 50 info codes are shown in the meter's display	
Clock/calendar (with backup battery)	Clock, calendar, leap year compensation, target date	
Daylight saving time/wintertime (DST)	Programmable under country code This function can be disabled so that "technical normal time" is used	
Time accuracy	Without external adjustment: Less than 15 min./year With external adjustment every 48 hours: Less than 7 s from legal time	
Data communication	KMP protocol with CRC16 used for optical communication as well as for modules.	
Power of temperature sensors	< 10 μ W RMS	

MULTICAL® 603

Internal supply voltage	3,6 VDC ± 0.1 VDC		
Battery	3,65 VDC, D-cell lithium	3,65 VDC, 2xA cell lithium	3,65 VDC, D-cell lithium IoT
Replacement interval	16 years @ $t_{BAT} < 30\text{ °C}$ 14 years @ $t_{BAT} < 40\text{ °C}$	9 years @ $t_{BAT} < 30\text{ °C}$ 7 years @ $t_{BAT} < 40\text{ °C}$	16 years @ CE-level 0 14 years @ CE-level 2
	See paragraph 10.4 for further information.		
Backup battery (for real-time clock)	3,0 VDC, BR-cell lithium Lifetime: 20 years @ $t_{BAT} < 40\text{ °C}$ with connected battery/supply or 4 years @ $t_{BAT} < 40\text{ °C}$ without connected battery/supply		
Mains supply	230 VAC +15/-30 %, 50/60 Hz 24 VAC ±50 %, 50/60 Hz or 24 VDC +75/-25 % (24 VDC for High Power SMPS only)		
Insulation voltage	3,75 kV		
Power consumption	< 1 W		
Backup supply	Integral super cap eliminates interruptions due to short-term power failures (only supply modules type 603-xxxxxxx7 and -8)		
EMC data	Fulfils EN 1434 class A and C (MID class E1 and E2)		

Temperature measurement	t1 Inlet	t2 Outlet	t3 Control	t4 Extra	$\Delta\Theta$ (t1-t2) Heat measurement	$\Delta\Theta$ (t2-t1) Cooling measurement	t5 Pre-setting for A1 and A2
603-A 2-Wire Pt500	Measuring range						
603-B 4-Wire Pt500							
603-C/E/F 2-Wire Pt500							
603-D/G/H 4-Wire Pt500							
603-M 2-Wire Pt500	0,00...185,00 °C (t1 and t2: Approved for 2,00...180,00 °C)						
	-40,00...140,00 °C						

Offset adjustment ± 0,99 K joint zero point adjustment for t1, t2 and t3
See paragraph 7.3

Note: The offset adjustment is only active on measured temperatures. If, for example, t3 has been selected for a preset value, the offset adjustment will not influence the preset value.

Max cable lengths	Pt100, 2-wire	Pt500, 2-wire
Max \varnothing 6 mm cable	2 x 0,25 mm ² : 2.5 m	2 x 0,25 mm ² : 10 m
	2 x 0,50 mm ² : 5 m	
	2 x 1,00 mm ² : 10 m	
		Pt100, 4-wire
	4 x 0,25 mm ² : 100 m	4 x 0,25 mm ² : 100 m

Flow measurement	ULTRAFLOW®	Reed switches	FET switches	24 V active pulses
V1 and V2	V1: 9-10-11 and V2: 9-69-11	V1: 10-11 and V2: 69-11	V1: 10-11 and V2: 69-11	V1: 10B-11B
CCC-code	1xx-2xx-4xx-5xx-8xx	0xx	9xx	2xx and 9xx
EN 1434 pulse class	IC	IB	IB	(IA)
Pulse input	680 k Ω pull-up to 3.6 V	680 k Ω pull-up to 3.6 V	680 k Ω pull-up to 3.6 V	12 mA at 24 V
Pulse ON	< 0,4 V for > 1 ms	< 0,4 V for > 300 ms	< 0,4 V for > 30 ms	< 4 V for > 3 ms
Pulse OFF	> 2,5 V for > 4 ms	> 2,5 V for > 100 ms	> 2,5 V for > 70 ms	> 12 V for > 4 ms
Pulse frequency	< 128 Hz	< 1 Hz	< 8 Hz	< 128 Hz
Integration frequency	< 1 Hz	< 1 Hz	< 1 Hz	< 1 Hz
Electrical isolation	No	No	No	2 kV
Max cable length	10 m	10 m	10 m	100 m
Max cable length with Cable Extender Box, Type 66-99-036	30 m	30 m	30 m	-

MULTICAL® 603

Pulse inputs A and B

In-A 65-66 and In-B: 67-68 via module

	Electronic switch	Reed switch
Pulse input	680 kΩ pull-up to 3,6 V	680 kΩ pull-up to 3,6 V
Pulse ON	< 0,4 V for > 30 ms	< 0,4 V for > 500 ms
Pulse OFF	> 2,5 V for > 30 ms	> 2,5 V for > 500 ms
Pulse frequency	< 3 Hz	< 1 Hz
Electrical isolation	No	No
Max cable length	25 m	25 m
Requirements to external	Leakage current at function open < 1 μA	
Update of display	Follows the selected integration interval (from 2 to 64 s)	

Pulse outputs C and D

Out-C: 16-17 and Out-D: 18-19 via module

			Pulse duration:
Pulse value	Heat meter:	Out-C = CE+	
		Out-D = CV	
<i>When pulse outputs are used for e.g. remote counting of energy and volume with the same resolution as the display¹</i>	Cooling meter:	Out-C = CE-	Selectable:
		Out-D = CV	10 ms, 32 ms or 100 ms
	Heat/cooling meter:	Out-C = CE+	
		Out-D = CE-	
Pulse value	Transmitter:	Out-C = V1	4 ms
<i>When pulse outputs are used as pulse transmitter/divider for e.g. regulation purposes</i>		Out-D = V2	
	Divider:	Out-C = V1/4	22 ms

Communication module

	HC-003-11 (Before 2017-05)	HC-003-11 (After 2017-05)
	HC-003-21 & -31 (Before 2018-04)	HC-003-21 & -31 (After 2018-04)
Pulse output type	Open collector (OB)	Opto FET
External voltage	5...30 VDC	1...48 VDC/AC
Current	< 10 mA	< 50 mA
Residual stress	$U_{CE} \approx 1 \text{ V}$ at 10 mA	$R_{ON} \leq 40 \Omega$
Electrical isolation	2 kV	2 kV
Max cable length	25 m	25 m

¹ At high resolution, the pulse outputs will be reduced by 1:10 when selecting 32 ms and 100 ms. See paragraph 3.2.10 about PP codes.

2.5 Mechanical data

Environmental class	Fulfils MID class M1 and M2
Ambient temperature	5...55°C, condensing, closed location (installation indoors)
Protection class	Calculator: IP 65 According to EN/IEC 60529

Medium temperatures

ULTRAFLOW®	} 2...130 °C	At media temperatures below the ambience temperature or above 90 °C in the flow sensor, we recommend that the calculator is wall-mounted.
Medium in ULTRAFLOW®		
Storage temperature	-25...60 °C (drained flow sensor)	
Connecting cable	ø3,5...6 mm	
Supply cable	ø5...8 mm	

2.6 Materials

Calculator case	Top and base	Thermoplastic, PC 10 % GF with TPE (thermoplastic elastomer)
	Verification cover	ABS
Cables	Silicone cable with inner Teflon insulation	

3 Type overview

MULTICAL® 603 can be ordered in countless combinations as required by the customer. First select the required hardware from the type overview, and next select the required software configuration via the configuration number (config number). Further, certain data is configured under the country code, which includes e.g. the definition of GMT, the primary M-Bus address as well as the yearly and monthly target date. Through these selections and configurations MULTICAL® 603 can be adjusted for its current task.

The meter has been configured from the factory and is ready for use. It can, however, be changed/reconfigured after installation. Reconfiguration can be carried out from the meter's "SETUP loop" or by means of either METERTOOL HCW or READY. Read more about METERTOOL HCW in Technical description (5512-2097) and about the "SETUP loop" in paragraph 6.3.



Type number:

>603-xxxx-xxxxxxxx<

The first 4 digits of the type number (603-xxxx-xxxxxxxx) are written on the meter's front and cannot be changed after production. The last 8 digits of the type number (603-xxxx-xxxxxxxx) are not written on the meter, but can be read from the display.

Config. number:

>A-B-CCC-DDD-EE-FF-GG-L-M-N-PP-RR-T-VVVV<

The config number is not written on the meter, but can be displayed distributed on four readings in "TECH loop".

Config 1: >A-B-CCC-DDD<

Flow sensor position-Measuring unit-Resolution-Display code

Config 2: >EE-FF-GG-L-M<

Tariff-Pulse inputs-Integration mode-Leakage

Config 3: >N-PP-RR-T<

Cold water leakage-Pulse outputs-Data logger profile-Encryption level

Config 4: >VVVV<

Customer label

Serial number:

>xxxxxxxx/WW/yy<

Consisting of:

8-digit serial number (xxxxxxxx)

2-digit device code for extended availability (WW)

2-digits for production year (yy)

The unique serial number is written on the meter and cannot be changed after factory programming.

Data:

During production MULTICAL® 603 is programmed with a number of measuring values. See paragraph 3.3 for more details about these measuring values.

3.1 Type number

MULTICAL® 603 type number

		Static data 603-xxxx		-		Dynamic data xxxxxxxx						
		Written on the meter's front				Can be displayed						
Type 603 -		□	-	□	-	□□	-	□	-	□□	-	□□
Calculator type												
Pt100 2-wire	t1-t2	V1	M-Bus	A								
Pt100 4-wire	t1-t2	V1	M-Bus	B								
Pt500 2-wire	t1-t2	V1	M-Bus	C								
Pt500 4-wire	t1-t2	V1	M-Bus	D								
Pt500 2-wire	t1-t2-t3	V1-V2		E								
Pt500 2-wire	t1-t2-t3	V1-V2	Backlit display ¹	F								
Pt500 4-wire	t1-t2	V1 (24 V active pulses)	M-Bus	G								
Pt500 4-wire	t1-t2	V1-V2		H								
Pt500 2-wire	t1-t2-t3	V1-V2	Mixed fluid only	M								
Meter type												
Heat meter		MID module B		1								
Heat meter		MID module B+D		2								
Heat/cooling meter		MID module B+D & TS 27.02 ²	Θ _{HC} = OFF	3								
Heat meter		National approval		4								
Cooling meter		TS 27.02+BEK1178		5								
Heat/cooling meter		MID module B+D & TS 27.02 ²	Θ _{HC} = ON	6								
Volume meter, hot				7								
Volume meter, cold				8								
Energy meter				9								
Country code												
See paragraph 3.3											XX	
Flow sensor connection type												
Delivered with one ULTRAFLOW®											1	
Delivered with two identical ULTRAFLOW®											2	
Prepared for one ULTRAFLOW®											7	
Prepared for two identical ULTRAFLOW®											8	
Prepared for flow sensor with fast and bounce-free electronic pulses											C	
Prepared for flow sensor with slow and bounce-free electronic pulses											J	
Prepared for flow sensor with slow pulses with bounce											L	
Prepared for flow sensor with 24 V active pulses											P	
Delivered with one flow sensor											G	
Mixed fluid only												
Temperature sensor set (see paragraph 9.2)												
No temperature sensors											00	
2-wire Pt500 temperature sensor pair												
Short direct sensor pair											DS 27,5 mm	
Short direct sensor pair											DS 38,0 mm	
Pocket sensor pair or 3 pairs											PL ø5,8 mm	
											L 1,5 m - 3,0 m	
											L 1,5 m - 3,0 m	
											L 1,5 m - 10,0 m	
											5x	
											2x	
											8x	
2-wire Pt100 temperature sensor pair												
Short direct sensor pair											DS 27,5 mm	
											L 2,0 m	
											J6	
4-wire Pt500/Pt100												
Pocket sensor pair with head											PL ø6,0 mm	
Pocket sensor pair with head											PL ø5,8 mm	
											L 105 mm – 230 mm	
											L 65 mm – 180 mm	
											Ax	
											Cx	

MULTICAL® 603

	□	□□	□□
Supply			
No supply	0		
Battery, 1 x D-cell	2		
230 VAC High Power SMPS	3		
24 VAC/VDC High Power SMPS	4		
Battery, 1 x D-cell IoT	5		
230 VAC power supply	7		
24 VAC power supply	8		
Battery, 2 x A-cells	9		
Communication module (2 module slots)			
No module		00	00
Data Pulse, inputs (In-A, In-B)		10	10
Data Pulse, outputs (Out-C, Out-D)		11	11
Wired M-Bus, inputs (In-A, In-B)		20	20
Wired M-Bus, outputs (Out-C, Out-D)		21	21
Wired M-Bus, Thermal Disconnect		22	22
linkIQ/wM-Bus, inputs (In-A, In-B), EU		32	-
linkIQ/wM-Bus, outputs (Out-C, Out-D), EU		33	-
wM-Bus, inputs (In-A, In-B), 912,5/915/918,5 MHz		34	-
Analog outputs 2 x 0/4...20 mA		40	40
Analog inputs 2 x 4...20 mA / 0...10 V		41	41
PQT Controller		43	43
Low Power Radio, inputs (In-A, In-B), 434 MHz		50	-
Low Power Radio GDPR, inputs (In-A, In-B), 434 MHz		51	-
NB-IoT, inputs (In-A, In-B)		56	-
NB-IoT (Elvaco)		58	-
LON TP/FT-10, inputs (In-A, In-B)		60	60
BACnet MS/TP, inputs (In-A, In-B)		66	66
Modbus RTU, inputs (In-A, In-B)		67	67
2G/4G Network, inputs (In-A, In-B)		80	-
BACnet IP, inputs (In-A, In-B)		81	81
Modbus/KMP TCP/IP, inputs (In-A, In-B)		82	82
High Power Radio Router, inputs (In-A, In-B), 444 MHz		84	-
High Power Radio Router GDPR, inputs (In-A, In-B), 444 MHz		85	-

¹ Backlight is on for 15 s after activation of push button and is only possible with calculator type MC603-F

² In some countries bi-functional meters type 3 and 6 are only allowed to be assigned with the MID marking, due to national law.

Guide for combinations of communication modules

1. **Wireless communication**
Only one wireless communication module
2. **Management and regulation**
Only one PQT or analog input module
3. **Internal antenna**
Internal antenna only on module slot 1 (M1)

3.1.1 Accessories

Supply modules

Article number	Description
HC-993-02	Battery module with one D-cell
HC-993-03	230 VAC High Power supply module
HC-993-04	24 VAC/VDC High Power supply module
HC-993-05	Battery module with one D-cell IoT
HC-993-07	230 VAC supply module
HC-993-08	24 VAC supply module
HC-993-09	Battery module with 2 A-cells
6699-047	Supply label, 10 pcs. (2006-681)

Various accessories

Article number	Description
3026-207.A	Wall bracket including mounting kit
3026-517	Sealing cap for sensor, blue, 2 pcs.
3026-518	Sealing cap for sensor, red, 2 pcs.
3026-1330	Sealing cap for DS sensor and R½" nipple, grey, 2 pcs. per sensor
3026-1331	Sealing cap for DS sensor and R¾" nipple, grey, 2 pcs. per sensor
2105-002	Sealing cap G¾B (R½) coupling
3026-1148	Sealing cap self locking G¾B (R½) coupling
3026-858.A	Perpendicular bracket ULTRAFLOW® (qp 0,6...2,5)
3026-909	Holder for optical reading head
3026-963	Separation tool base
3130-262	Blind plug with o-ring
3130-269	Cable relief set
5000-337	Module cable 2 m (2x0,25 m²)
6699-035	USB cable for module configuration
6699-036	Cable Extender Box
6699-042	Metal plate for optical reader 20 pcs.
6696-005	Bluetooth optical reading head
6699-099	Infrared optical reading head w/USB plug
6699-110	Panel mounting kit
6699-447.E	Internal antenna for Kamstrup radio, 434 MHz
6699-448	Mini Triangle antenna for Wireless M-Bus and 2G/4G Network Module
6699-482.E	Internal antenna for wM-Bus, 868 MHz

Calibration units

Article number	Description
6699-363	MULTICAL® 603, 2-wire Pt500, Heat/Cooling (used with METERTOOL HCW)
6699-364	MULTICAL® 603, 4-wire Pt500, Heat/Cooling (used with METERTOOL HCW)
6699-365	MULTICAL® 603, 2/4-wire Pt100, Heat/Cooling (used with METERTOOL HCW)

MULTICAL® 603

Software

Article number	Description
6699-724	METER TOOL HCW
6699-725	LogView HCW

Couplings

Article number	Description
6561-323	Coupling incl. gasket, DN15, G $\frac{3}{4}$ B - R $\frac{1}{2}$, 2 pcs
6561-324	Coupling incl. gasket, DN20, G1B - R $\frac{3}{4}$, 2 pcs
6561-349	Coupling incl. gasket, DN25, G1 $\frac{1}{4}$ B - R1, 2 pcs
6561-350	Coupling incl. gasket, DN32, G1 $\frac{1}{2}$ B - R1 $\frac{1}{4}$, 2 pcs
6561-351	Coupling incl. gasket, DN40, G2B - R1 $\frac{1}{2}$, 2 pcs

Extensions

Article number	Description
1330-010	Extensions excl. gaskets, 110 - 165 mm/165 - 220 mm, G $\frac{3}{4}$ B - G1B, 1 item. *
1330-011	Extensions excl. gaskets, 190 - 220 mm, G1B - G1B, 1 pc.
1330-012	Extensions excl. gaskets, 110 - 220 mm, G $\frac{3}{4}$ B - G1B, 1 pc. *
1330-013	Extensions excl. gaskets, 110 - 130 mm, G $\frac{3}{4}$ B - G1B, 1 pc. *
1330-015	Extensions excl. gaskets, 110 - 130 mm, G $\frac{3}{4}$ B - G $\frac{3}{4}$ B, 1 pc.
1330-019	Extensions excl. gaskets, 110 - 165 mm, G $\frac{3}{4}$ B - G $\frac{3}{4}$ B, 1 pc.

* 2 pcs to be ordered per meter

Sensor nipples and pockets

Article number	Description
6561-330	11 mm adapter for 38 mm short direct sensor
6556-546	R $\frac{1}{2}$ nipple for Pt500 short direct sensor
6556-547	R $\frac{3}{4}$ nipple for Pt500 short direct sensor
6557-324	R $\frac{1}{2}$ x 65 mm sensor pocket, \varnothing 5,8 mm
6557-327	R $\frac{1}{2}$ x 90 mm sensor pocket, \varnothing 5,8 mm
6557-314	R $\frac{1}{2}$ x 140 mm sensor pocket, \varnothing 5,8 mm

Ball valves

Article number	Description
6556-570	$\frac{1}{2}$ " ball valve with M10 connection for direct temperature sensor
6556-571	$\frac{3}{4}$ " ball valve with M10 connection for direct temperature sensor
6556-572	1" ball valve with M10 connection for direct temperature sensor
6556-526	1 $\frac{1}{4}$ " ball valve with M10 connection for direct temperature sensor
6556-527	1 $\frac{1}{2}$ " ball valve with M10 connection for direct temperature sensor

Gaskets

Article number	Description
2210-233	Gasket for short direct temperature sensor, 1 pc.
2210-061	Gasket for G $\frac{3}{4}$ B (R $\frac{1}{2}$) flow sensor (thread), 1 pc.
2210-062	Gasket for G1B (R $\frac{3}{4}$) flow sensor (thread), 1 pc.
2210-063	Gasket for G1 $\frac{1}{4}$ B (R1) flow sensor (thread), 1 pc.
2210-065	Gasket for G2B (R1 $\frac{1}{2}$) flow sensor (thread), 1 pc.
2210-133	Gasket for DN25 PN25 flow sensor (flange), 1 pc.
2210-132	Gasket for DN40 PN25 flow sensor (flange), 1 pc.
2210-099	Gasket for DN50 PN25 flow sensor (flange), 1 pc.

Safety transformer

Article number	Description
6699-403	230/24 VAC safety transformer 5 VA
6699-404	230/24 VAC safety transformer 10 VA
6699-405	230/12/24 VAC safety transformer 63 VA

Contact Kamstrup A/S for questions about further accessories.

3.2 Configuration number

The software configuration of MULTICAL® 603 is defined on the basis of the configuration number. Below you see an overview of the meter’s configuration number. Each part of the configuration number is described in more detail in the following paragraphs.

	A	B	CCC	DDD	EE	FF	GG	L	M	N	PP	RR	T	VVV
Flow sensor position														
Inlet	3													
Outlet	4													
Measuring unit														
GJ		2												
kWh		3												
MWh		4												
Gcal		5												
Auto Detect CCC codes (UF x4)														
Normal resolution (7 digits)			8 0 7											
High resolution (8 digits)			8 1 8											
Static CCC codes														
Reed switch (7 digits)			0 x x											
Electronic, fast pulse (7 digits)			1 x x											
Electronic, fast pulse (8 digits)			2 x x											
Kamstrup, UF X4 (7 digits)			4 x x											
Kamstrup, UF X4 (8 digits)			5 x x											
Electronic, slow pulse (7 digits)			9 x x											
Display														
Heat meter (standard)				210										
Heat/cooling meter (standard)				310										
Cooling meter (standard)				510										
Heat/cooling meter (standard)				610										
Tariffs														
No active tariff					00									
Power tariff					11									
Flow tariff					12									
t1-t2 tariff					13									
Inlet tariff					14									
Outlet tariff					15									
Time controlled tariff					19									
Heat/cooling volume tariff					20									
PQ-tariff					21									
Pulse inputs A and B														
10 m³/h, 10 l/imp, pre-counter 1 (standard)						24	24							
Integration mode														
Adaptive mode (2-64 s)		Display on							1					
Normal mode (32 s)		Display on							2					
Fast mode (8 s)		Display on							3					
Fast mode (2 s)		Display on							4					
Adaptive mode (2-64 s)		Display off							5					
Normal mode (32 s)		Display off							6					
Fast mode (8 s)		Display off							7					
Leakage limits (V1/V2)														
OFF										0				
1,0 % of qp + 20 % of q										1				
1,0 % of qp + 10 % of q										2				
0,5 % of qp + 20 % of q										3				
0,5 % of qp + 10 % of q										4				
Leakage limit, cold water (In-A/In-B)														
OFF												0		
30 min. without pulses												1		
One hour without pulses												2		
Two hours without pulses												3		
Pulse outputs C and D														
Out-C: V1/4					5 ms									73
Out-C: V1/1, Out-D: V2/1					3,9 ms									80
Out-C: V1/1					3,9 ms									82
Out-C: V1/4					22 ms									83
E1 and V1 or E3 and V1					10 ms									94
E1 and V1 or E3 and V1					32 ms									95
E1 and V1 or E3 and V1					100 ms (0,1 s)									96
Controlled output based on data commands														99

	RR	T	VVV
Data logger profile ¹			
Standard data logger profile	10		
Current values	11		
Ludwig	12		
Madrid	13		
Peter	14		
Diagnostic	15		
Kiev	17		
Information sensitive	18		
KM RF	90		
Encryption level			
Common key		2	
Individual key		3	
Customer label			
See paragraph 3.2.13			XXXX

¹ For more data logger profiles, see document "Logger profiles and datagrams" at:
www.kamstrup.com/en-en/product-centre

3.2.1 Flow sensor position >A<

The A-code indicates installation of flow sensor in inlet or outlet. As the density and heat capacity of water vary with temperature, the calculator must correct for this based on installation type (A-code). Incorrect programming or installation leads to error of measuring. See paragraph 4.3 for further details on installation of flow sensor in inlet and outlet in heat and cooling installations.

Flow sensor position	A-code
Inlet	3
Outlet	4

3.2.2 Measuring unit >B<

The B-code indicates the measuring unit used in the energy register. The options are GJ, kWh, MWh or Gcal.

Measuring unit	B-code
GJ	2
kWh	3
MWh	4
Gcal ¹	5

¹ Be aware that Gcal is not an SI unit.

MULTICAL® 603

3.2.3 Flow sensor coding >CCC<

The CCC-code optimises the display resolution for the selected flow sensor size, and at the same time the type approval regulations as to minimum resolution and maximum register overflow are observed. Below, the possible display resolutions with MULTICAL® 603 according to the type approval rules are shown.

		Number of decimals in display							
		Energy			Volume / Mass	Flow / Power			
qp [m³/h]	7/8 digits	kWh	MWh Gcal	GJ	m³ tons	l/h	m³/h	kW	MW
0,6 ≤ 1,5	7	1	4	3	3	0	-	1	-
0,6 ≤ 15	7	0	3	2	2	0	-	1	-
	8	1	4	3	3				-
4 ≤ 150	7	-	2	1	1	-	2	0	-
	8	0	3	2	2				-
40 ≤ 1500	7	-	1	0	0	-	1	-	2
	8	-	2	1	1				-
400 ≤ 15000	7	-	-	-	-	-	-	-	-
	8	-	1	0	0		0		1

The CCC codes for MULTICAL® 603 are grouped according to the type of connected flow sensor. Nine groups have been created, which are all tied to a connection type. The connection type is selected as part of the meter's type number.

CCC	Flow sensor type	Pulse frequency	Bounce damping	Pulses + Data	Auto Detect	7/8 digits	Connection type		Pulse time	
							Direct	Opto	ON (LO)	OFF (HI)
0XX	Mechanical meters delivering slow pulses with bounce	< 1 Hz	Yes	P		7/8	L	-	>300 ms	>10 ms
1XX	Electronic meters with quick and bounce-free pulses	< 128 Hz	No	P	No	7	C ²	P	>1 ms	>4 ms
2XX						8				
4XX	Electronic meters with quick and bounce-free pulses as well as data for info codes for ULTRAFLOW® X4	< 128 Hz	No	P+D	No	7	1-2-7-8 ¹	-	>1 ms	>4 ms
5XX						8				
8XX	Electronic meters with quick and bounce-free pulses as well as data for info codes for ULTRAFLOW® X4 and Auto Detect	< 128 Hz	No	P	Yes	7/8				
9XX	Electronic meters with slow and bounce-free pulses	< 8 Hz	No	P	No		J	P	>30 ms	>100 ms

¹ Connection type 1-2 means connection of 1 or 2 provided ULTRAFLOW®, 7-8 means prepared for 1 or 2 ULTRAFLOW®.

² Connection type C is used for previous versions of ULTRAFLOW® such as ULTRAFLOW® II and ULTRAFLOW® 65.

In the following five paragraphs, the CCC codes are described.

- 3.2.3.1 ULTRAFLOW® X4
- 3.2.3.2 Mechanical flow sensors, reed switch
- 3.2.3.3 Electronic flow sensors, slow pulses
- 3.2.3.4 Electronic flow sensors, fast pulses
- 3.2.3.5 ULTRAFLOW® II, 65-SRT and X4

3.2.3.1 ULTRAFLOW® X4

Auto Detect enables the exchange of ULTRAFLOW® X4 on MULTICAL® 603 without changing the CCC code. MULTICAL® 603 can automatically adapt its CCC code to match the connected ULTRAFLOW® X4 via the function Auto Detect. Auto Detect is active with CCC code 8xx.

Auto Detect functions in such a way that MULTICAL® 603 during start-up automatically retrieves the correct information about pulse figure and qp from the connected ULTRAFLOW® X4 flow sensors. MULTICAL® 603 adapts its configuration to the values received from ULTRAFLOW® X4. Auto Detect is initiated when the calculator top and base are separated and reassembled. Read more about the connection of ULTRAFLOW® and Auto Detect in paragraph 8.1.

MULTICAL® 603 can be delivered with Auto Detect if this is delivered with a CCC code 8xx, but can also be delivered with a static CCC code 4xx (7 digits) or 5xx (8 digits). After the delivery, it is possible to change the CCC code and select Auto Detect and vice versa.

4XX		5XX	
Normal resolution 7 digits	High resolution 7 digits	Normal resolution 8 digits	High resolution ¹ 8 digits

CCC	qp	Imp./L	7/8 digits	Number of decimals in display								Connection type
				kWh ²	MWh Gcal	GJ	m ³ tons	l/h	m ³ /h	kW	MW	
807	0,6...1000	300...0,15	7	Auto Detect, CCC codes: 416-419-498-451-437-478-420-479-458-470-480-447-481-491-492-493								1-2-7-8
808 ¹	0,6...1000	300...0,15	8	Auto Detect, CCC codes: 584-507-598-551-537-578-520-579-558-570-580-547-581-591-592-593								1-2-7-8
818	0,6...1000	300...0,15	8	Auto Detect, CCC codes: 584-507-598-536-538-583-585-579-586-587-588-589-581-591-592-593								1-2-7-8

¹ With this CCC code, the number of pulses on the pulse outputs is reduced by factor 10 when selecting the PP codes 95 (32 ms), 96 (100 ms) and 93 (250 ms). The number of pulses is not reduced when selecting PP code 94 (10 ms).

² When kWh is selected, the calculator automatically switches to MWh if the CCC code is selected for large meters.

MULTICAL® 603

4XX				5XX			
Normal resolution 7 digits		High resolution 7 digits		Normal resolution 8 digits		High resolution ¹ 8 digits	

CCC	qp	Imp./L	7/8 digits	Number of decimals in display								Connection type
				kWh	MWh Gcal	GJ	m ³ tons	l/h	m ³ /h	kW	MW	
416	0,6	300	7	0	3	2	2	0	-	1	-	1-2-7-8
484	0,6	300	7	1	4	3	3	0	-	1	-	1-2-7-8
584 ¹	0,6	300	8	1	4	3	3	0	-	1	-	1-2-7-8
419	1,5	100	7	0	3	2	2	0	-	1	-	1-2-7-8
407	1,5	100	7	1	4	3	3	0	-	1	-	1-2-7-8
507 ¹	1,5	100	8	1	4	3	3	0	-	1	-	1-2-7-8
498	2,5	60	7	0	3	2	2	0	-	1	-	1-2-7-8
598 ¹	2,5	60	8	1	4	3	3	0	-	1	-	1-2-7-8
451	3,5	50	7	-	2	1	1	0	-	1	-	1-2-7-8
436	3,5	50	7	0	3	2	2	0	-	1	-	1-2-7-8
551	3,5	50	8	0	3	2	2	0	-	1	-	1-2-7-8
536	3,5	50	8	1	4	3	3	0	-	1	-	1-2-7-8
437	6	25	7	-	2	1	1	0	-	1	-	1-2-7-8
438	6	25	7	0	3	2	2	0	-	1	-	1-2-7-8
537	6	25	8	0	3	2	2	0	-	1	-	1-2-7-8
538	6	25	8	1	4	3	3	0	-	1	-	1-2-7-8
478	10	15	7	-	2	1	1	0	-	1	-	1-2-7-8
483	10	15	7	0	3	2	2	0	-	1	-	1-2-7-8
578	10	15	8	0	3	2	2	0	-	1	-	1-2-7-8
583	10	15	8	1	4	3	3	0	-	1	-	1-2-7-8
420	15	10	7	-	2	1	1	0	-	1	-	1-2-7-8
485	15	10	7	0	3	2	2	0	-	1	-	1-2-7-8
520	15	10	8	0	3	2	2	0	-	1	-	1-2-7-8
585	15	10	8	1	4	3	3	0	-	1	-	1-2-7-8
479	25	6	7	-	2	1	1	-	2	0	-	1-2-7-8
579 ¹	25	6	8	0	3	2	2	-	2	0	-	1-2-7-8
458	40	5	7	-	1	0	0	-	2	0	-	1-2-7-8
486	40	5	7	-	2	1	1	-	2	0	-	1-2-7-8
558	40	5	8	-	2	1	1	-	2	0	-	1-2-7-8
586	40	5	8	0	3	2	2	-	2	0	-	1-2-7-8
470	60	2,5	7	-	1	0	0	-	2	0	-	1-2-7-8
487	60	2,5	7	-	2	1	1	-	2	0	-	1-2-7-8
570	60	2,5	8	-	2	1	1	-	2	0	-	1-2-7-8
587	60	2,5	8	0	3	2	2	-	2	0	-	1-2-7-8
480	100	1,5	7	-	1	0	0	-	2	0	-	1-2-7-8
488	100	1,5	7	-	2	1	1	-	2	0	-	1-2-7-8
580	100	1,5	8	-	2	1	1	-	2	0	-	1-2-7-8
588	100	1,5	8	0	3	2	2	-	2	0	-	1-2-7-8
447	150	1	7	-	1	0	0	-	2	0	-	1-2-7-8
489	150	1	7	-	2	1	1	-	2	0	-	1-2-7-8
547	150	1	8	-	2	1	1	-	2	0	-	1-2-7-8
589	150	1	8	0	3	2	2	-	2	0	-	1-2-7-8
481	250	0,6	7	-	1	0	0	-	1	-	2	1-2-7-8
581 ¹	250	0,6	8	-	2	1	1	-	1	-	2	1-2-7-8
491	400	0,4	7	-	1	0	0	-	1	-	2	1-2-7-8
591 ¹	400	0,4	8	-	2	1	1	-	1	-	2	1-2-7-8
492	600	0,25	7	-	1	0	0	-	1	-	2	1-2-7-8

4XX		5XX	
Normal resolution 7 digits	High resolution 7 digits	Normal resolution 8 digits	High resolution ¹ 8 digits

CCC	qp	Imp./L	7/8 digits	Number of decimals in display								Connection type
				kWh	MWh Gcal	GJ	m ³ tons	l/h	m ³ /h	kW	MW	
592 ¹	600	0,25	8	-	2	1	1	-	1	-	2	1-2-7-8
493	1000	0,15	7	-	1	0	0	-	1	-	2	1-2-7-8
593 ¹	1000	0,15	8	-	2	1	1	-	1	-	2	1-2-7-8

¹ On this CCC code, the number of pulses on the pulse outputs is divided by factor 10 when selecting PP codes 95 (32 ms), 96 (100 ms) and 93 (250 ms). The number of pulses is not divided when selecting PP code 94 (10 ms).

MULTICAL® 603

3.2.3.2 Mechanical flow sensors, reed switch

CCC	qp	L/imp.	7/8 digits	Number of decimals in display								Connection type
				kWh	MWh Gcal	GJ	m ³ tons	l/h	m ³ /h	kW	MW	
010	0,6...1.5	1	7	1	4	3	3	0	-	1	-	L
011	1,0...15	10	7	0	3	2	2	0	-	1	-	L
012	10...150	100	7	-	2	1	1	-	2	0	-	L
032 ¹	10...150	100	8	0	3	2	2	-	2	0	-	L
013	100...1.500	1.000	7	-	1	0	0	-	1	-	2	L
033 ¹	100...1.500	1.000	8	-	2	1	1	-	1	-	2	L
020	0,6...4	2,5	7	0	3	2	2	0	-	1	-	L
021	3...40	25	7	-	2	1	1	-	2	0	-	L
022	30...400	250	7	-	1	0	0	-	1	-	2	L

¹ With this CCC code, the number of pulses on the pulse outputs is reduced by factor 10 when selecting the PP codes 95 (32 ms) and 96 (100 ms). The number of pulses is not reduced when selecting PP code 94 (10 ms).

3.2.3.3 Electronic flow sensors, slow pulses

CCC	qp	L/imp.	7/8 digits	Number of decimals in display								Connection type
				kWh	MWh Gcal	GJ	m ³ tons	l/h	m ³ /h	kW	MW	
910	0,6...1,5	1	7	1	4	3	3	0	-	1	-	J-P
935	0,6...10	1	8	0	3	2	2	0	-	1	-	J-P
911	1,5...15	10	7	0	3	2	2	0	-	1	-	J-P
936	10...100	10	8	-	2	1	1	-	2	0	-	J-P
912	15...150	100	7	-	2	1	1	-	2	0	-	J-P
932 ¹	15...150	100	8	0	3	2	2	-	2	0	-	J-P
913	150...1.500	1.000	7	-	1	0	0	-	1	-	2	J-P
933 ¹	150...1.500	1.000	8	-	2	1	1	-	1	-	2	J-P
934 ^{1,2}	150...15.00	1.000	8	-	1	0	0	-	0	-	1	J-P
920	0,6...15	2,5	7	0	3	2	2	0	-	1	-	J-P
921	4...150	25	7	-	2	1	1	-	2	0	-	J-P
922	40...1.500	250	7	-	1	0	0	-	1	-	2	J-P

¹ With this CCC code, the number of pulses on the pulse outputs is reduced by factor 10 when selecting the PP codes 95 (32 ms) and 96 (100 ms). The number of pulses is not reduced when selecting PP code 94 (10 ms).

² $qs = 1,8 \times qp$

3.2.3.4 Electronic flow sensors, fast pulses

CCC	qp	imp./L	7/8 digits	Number of decimals in display							Connection type
				kWh	MWh Gcal	GJ	m ³ ton	m ³ /h	kW	MW	
175	15...30	7,5	7	-	1	0	0	2	0	-	C-P
176	25...50	4,5	7	-	1	0	0	2	0	-	C-P

CCC	qp	L/imp.	7/8 digits	Number of decimals in display							DN size	Connection type
				kWh	MWh Gcal	GJ	m ³ tons	m ³ /h	kW	MW		
201 ¹	4...150	1	8	0	3	2	2	2	0	-	25-200	C-P
202 ¹	40...400	2,5	8	-	2	1	1	1	-	2	65-300	C-P
204 ¹	40...1.500	10	8	-	2	1	1	1	-	2	65-600	C-P
205 ¹	400...8.000	50	8	-	1	0	0	0	-	1	250-1400	C-P
206 ¹	400...15.000	100	8	-	1	0	0	0	-	1	250-1800	C-P

¹ With this CCC code, the number of pulses on the pulse outputs is reduced by factor 10 when selecting the PP codes 95 (32 ms)

and 96 (100 ms). The number of pulses is not reduced when selecting PP code 94 (10 ms).

Note: CCC = 201...205 consisted of 7 digits in MULTICAL® 602, but in MULTICAL® 603, they consist of 8 digits. CCC = 206 was only available in MULTICAL® 801, but is now also available in MULTICAL® 603.

3.2.3.5 ULTRAFLOW® II, 65-SRT and X4

CCC	qp	Imp./L	7/8 digits	Number of decimals in display								Connection type
				kWh	MWh Gcal	GJ	m ³ tons	l/h	m ³ /h	kW	MW	
116	0,6	300	7	0	3	2	2	0	-	1	-	C-P
184	0,6	300	7	1	4	3	3	0	-	1	-	C-P
284	0,6	300	8	1	4	3	3	0	-	1	-	C-P
119	1,5	100	7	0	3	2	2	0	-	1	-	C-P
107	1,5	100	7	1	4	3	3	0	-	1	-	C-P
207	1,5	100	8	1	4	3	3	0	-	1	-	C-P
198	2,5	60	7	0	3	2	2	0	-	1	-	C-P
298 ¹	2,5	60	8	1	4	3	3	0	-	1	-	C-P
151	3,5	50	7	-	2	1	1	0	-	1	-	C-P
136	2,5-3,5	50	7	0	3	2	2	0	-	1	-	C-P
236 ¹	3,5	50	8	1	4	3	3	0	-	1	-	C-P
137	6	25	7	-	2	1	1	0	-	1	-	C-P
138	6	25	7	0	3	2	2	0	-	1	-	C-P
238 ¹	6	25	8	1	4	3	3	0	-	1	-	C-P
100	10	25	7	-	2	1	1	0	-	1	-	C-P
178	10	15	7	-	2	1	1	0	-	1	-	C-P
183	10	15	7	0	3	2	2	0	-	1	-	C-P
283 ¹	10	15	8	1	4	3	3	0	-	1	-	C-P
120	15	10	7	-	2	1	1	0	-	1	-	C-P
185	15	10	7	0	3	2	2	0	-	1	-	C-P
285 ¹	15	10	8	1	4	3	3	0	-	1	-	C-P
101	25	10	7	-	2	1	1	0	-	1	-	C-P
179	25	6	7	-	2	1	1	-	2	0	-	C-P
279 ¹	25	6	8	0	3	2	2	-	2	0	-	C-P
158	40	5	7	-	1	0	0	-	2	0	-	C-P
186	40	5	7	-	2	1	1	-	2	0	-	C-P
286 ¹	40	5	8	0	3	2	2	-	2	0	-	C-P
170	60	2,5	7	-	1	0	0	-	2	0	-	C-P
187	60	2,5	7	-	2	1	1	-	2	0	-	C-P
287 ¹	60	2,5	8	0	3	2	2	-	2	0	-	C-P
180	100	1,5	7	-	1	0	0	-	2	0	-	C-P
188	100	1,5	7	-	2	1	1	-	2	0	-	C-P
288 ¹	100	1,5	8	0	3	2	2	-	2	0	-	C-P
147	150	1	7	-	1	0	0	-	2	0	-	C-P
189	150	1	7	-	2	1	1	-	2	0	-	C-P
289 ¹	150	1	8	0	3	2	2	-	2	0	-	C-P
181	250	0,6	7	-	1	0	0	-	1	-	2	C-P
281 ¹	250	0,6	8	-	2	1	1	-	1	-	2	C-P
191	400	0,4	7	-	1	0	0	-	1	-	2	C-P
291 ¹	400	0,4	8	-	2	1	1	-	1	-	2	C-P
192	600	0,25	7	-	1	0	0	-	1	-	2	C-P
292 ¹	600	0,25	8	-	2	1	1	-	1	-	2	C-P
195 ²	1000	0,25	7	-	1	0	0	-	1	-	2	C-P
193	1000	0,15	7	-	1	0	0	-	1	-	2	C-P
293 ¹	1000	0,15	8	-	2	1	1	-	1	-	2	C-P

¹ With this CCC code, the number of pulses on the pulse outputs is reduced by factor 10 when selecting the PP codes 95 (32 ms) and 96 (100 ms). The number of pulses is not reduced when selecting PP code 94 (10 ms).

² $qs = 1.8 \times qp$

The choice of 7 or 8 digits may influence the data communication

If the reading device has been hard coded to a given number of digits for the individual registers, there may occur errors in the data communication if you select, for example, 8 digits on the meter, while the reading device is hard coded to, for example, 7 digits.

This type of error most often occurs in systems in which meter and reading device use different communication types, e.g. a PLC system in which the communication to an M-Bus converter takes place via RS-232 and the communication to a MULTICAL® meter takes place via M-Bus. In case of suspicion that an error in the data communication is caused by this, it can be checked by changing the CCC code in MULTICAL® to a variant with another number of digits but of the same flow meter size.

To change the CCC code, an optical read-out head and METERTOOL are used.

3.2.4 Display code >DDD<

MULTICAL® 603 has 4 display loops; USER, TECH, SETUP and TEST. The "TECH loop" contains all display readings, with the exception of logged values and the differential registers, and this loop is *not* configurable. "USER loop", however, is configurable and can be adapted to customer requirements by means of the DDD code (display code). As a minimum, the "USER loop" comprises the meter's legal readings.

The meter's legal readings, e.g. energy and volume reading, are basically displayed as 7-digit values. The display readings can be configured to 8-digit values via the CCC code.



The first digits of the three-digit DDD-code define the meter type comprised by the DDD-code in question. The table shows examples of a number of DDD-codes within each meter type. In the table, "1" indicates the first primary reading, whereas e.g. "1A" is the first secondary reading. The display automatically returns to reading "1" after 4 minutes. Contact Kamstrup A/S for information about available display codes.

Displayref.	Primary reading 	Displayref.	Secondary reading 	Heat meter DDD = 110	Heat meter DDD = 210	Heat/cooling meter DDD = 310	Heat meter DDD = 410	Cooling meter DDD = 510	Heat/cooling meter DDD = 610	Volume meter DDD = 710
1.0	Heat energy (E1)			1	1	1	1		1	
		1.1	Date of yearly logger	1A	1A	1A	1A		1A	
		1.2	Data of yearly logger ¹							
		1.3	Date of monthly logger	1B	1B	1B	1B		1B	
		1.4	Data of monthly logger ¹							
		1.5	E1 High-resolution							
2.0	Cooling energy (E3)					2		1	2	
		2.1	Date of yearly logger			2A		1A	2A	
		2.2	Data of yearly logger ¹							
		2.3	Date of monthly logger			2B		1B	2B	
		2.4	Data of monthly logger ¹							
		2.5	E3 High-resolution							
3.0	Energy E2									
		3.1	Energy E4							
		3.2	Energy E5							
		3.3	Energy E6							
		3.4	Energy E7							
4.0	Volume V1			2	2	3	2	2	3	1
		4.1	Mass V1							
		4.2	Pressure P1							
		4.3	Date of yearly logger	2A	2A	3A	2A	2A	3A	1A
		4.4	Data of yearly logger ¹							
		4.5	Date of monthly logger	2B	2B	3B	2B	2B	3B	1B
		4.6	Data of monthly logger ¹							
		4.7	V1 High-resolution							
5.0	Volume V2									
		5.1	Mass V2							
		5.2	Pressure P2							
		5.3	Date of yearly logger							
		5.4	Data of yearly logger ¹							
		5.5	Date of monthly logger							
		5.6	Data of monthly logger ¹							

MULTICAL® 603

Displayref.	Primary reading 	Displayref.	Secondary reading 	Heat meter DDD = 110	Heat meter DDD = 210	Heat/cooling meter DDD = 310	Heat meter DDD = 410	Cooling meter DDD = 510	Heat/cooling meter DDD = 610	Volume meter DDD = 710
6.0	Hour counter			3	3	4	3	3	4	2
		6.1	<i>Error hour counter</i>	3A	3A	4A	3A	3A	4A	2A
7.0	t1 (inlet)			4	4	5	4	4	5	
		7.1	<i>Year-to-date average ²</i>	4A	4A	5A	4A	4A	5A	
		7.2	<i>Month-to-date average ²</i>	4B	4B	5B	4B	4B	5B	
8.0	t2 (outlet)			5	5	6	5	5	6	
		8.1	<i>Year-to-date average ²</i>	5A	5A	6A	5A	5A	6A	
		8.2	<i>Month-to-date average ²</i>	5B	5B	6A	5B	5B	6B	
9.0	t1-t2 ($\Delta\theta$) (cooling indicated by -)			6	6	7	6	6	7	
		9.1	<i>E8 (V1 x t1)</i>							
		9.2	<i>E9 (V1 x t2)</i>							
10.0	t3									
		10.1	<i>E10 (V1 x t3)</i>							
		10.2	<i>E11 (V2 x t3)</i>							
11.0	t4 (programmed)									
12.0	Flow (V1)			7	7	8	7	7	8	3
		12.1	<i>Date of max this year ³</i>	7A	7A	8A	7A	7A	8A	3A
		12.2	<i>Data of max this year ¹</i>							
		12.3	<i>Date of max yearly logger</i>							
		12.4	<i>Data of max yearly logger ¹</i>							
		12.5	<i>Date of max this month ³</i>	7B	7B	8B	7B	7B	8B	3B
		12.6	<i>Data of max this month ¹</i>							
		12.7	<i>Date of max monthly logger</i>							
		12.8	<i>Data of max monthly logger 1</i>							
		12.9	<i>Date of min. this year ³</i>	7C	7C	8C	7C	7C	8C	3C
		12.10	<i>Data of min. this year ¹</i>							
		12.11	<i>Date of min. yearly logger</i>							
		12.12	<i>Data of min. yearly logger ¹</i>							
		12.13	<i>Date of min. this month ³</i>	7D	7D	8D	7D	7D	8D	3D
		12.14	<i>Data of min. this month ¹</i>							
		12.15	<i>Date of min. monthly logger</i>							
		12.16	<i>Data of min. monthly logger ¹</i>							
13.0	Flow (V2)									
14.0	Thermal power (V1)			8	8	9	8	8	9	
		14.1	<i>Date of max this year ³</i>	8A	8A	9A	8A	8A	9A	
		14.2	<i>Data of max this year ¹</i>							
		14.3	<i>Date of max yearly logger</i>							
		14.4	<i>Data of max yearly logger ¹</i>							
		14.5	<i>Date of max this month ³</i>	8B	8B	9B	8B	8B	9B	
		14.6	<i>Data of max this month ¹</i>							
		14.7	<i>Date of max monthly logger</i>							
		14.8	<i>Data of max monthly logger 1</i>							

Displayref.	Primary reading 	Displayref.	Secondary reading 	Heat meter DDD = 110	Heat meter DDD = 210	Heat/cooling meter DDD = 310	Heat meter DDD = 410	Cooling meter DDD = 510	Heat/cooling meter DDD = 610	Volume meter DDD = 710
		14.9	Date of min. this year ³	8C	8C	9C	8C	8C	9C	
		14.10	Data of min. this year ¹							
		14.11	Date of min. yearly logger							
		14.12	Data of min. yearly logger ¹	8D	8D	9D	8D	8D	9D	
		14.13	Date of min. this month ³							
		14.14	Data of min. this month ¹							
		14.15	Date of min. monthly logger							
		14.16	Data of min. monthly logger ¹	9	9	10	9	9	10	4
15.0	Input A1 ⁴									
		15.1	Meter number of input A1							
		15.2	L/imp. of input A1							
		15.3	Date of yearly logger							
		15.4	Data of yearly logger ¹							
		15.5	Date of monthly logger							
		15.6	Data of monthly logger ¹							
16.0	Input B1 ⁴			10	10	11	10	10	11	5
		16.1	Meter number of input B1							
		16.2	L/imp. or Wh/imp. of input B1							
		16.3	Date of yearly logger							
		16.4	Data of yearly logger ¹							
		16.5	Date of monthly logger							
		16.6	Data of monthly logger ¹							
17.0	Input A2 ⁴									
		17.1	Meter number of input A2							
		17.2	L/imp. of input A2							
		17.3	Date of yearly logger							
		17.4	Data of yearly logger ¹							
		17.5	Date of monthly logger							
		17.6	Data of monthly logger ¹							
18.0	Input B2 ⁴									
		18.1	Meter number of input B2							
		18.2	L/imp. or Wh/imp. of input B2							
		18.3	Date of yearly logger							
		18.4	Data of yearly logger ¹							
		18.5	Date of monthly logger							
		18.6	Data of monthly logger ¹							
19.0	TA2			11	11	12	11	11	12	6
		19.1	TL2							
20.0	TA3			12	12	13	12	12	13	7
		20.1	TL3							

Displayref.	Primary reading 	Displayref.	Secondary reading 	Heat meter DDD = 110	Heat meter DDD = 210	Heat/cooling meter DDD = 310	Heat meter DDD = 410	Cooling meter DDD = 510	Heat/cooling meter DDD = 610	Volume meter DDD = 710
21.0	TA4			13	13	14	13	13	14	8
		21.1	TL4	13A	13A	14A	13A	13A	14A	8A
22.0	A1 Heat energy with discount (A-)									
		22.1	A2 Heat energy with surcharge (A+)							
		22.2	t5							
23.0	CP (moving average)									
		23.1	Actual power of input B1 ⁵							
		23.2	Date of yearly logger							
		23.4	Data of yearly logger ¹							
		23.5	Date of monthly logger							
		23.6	Data of monthly logger ¹							
24.0	Info code			14	14	15	14	14	15	9
		24.1	Info event counter	14A	14A	15A	14A	14A	15A	9A
		24.2	Date for info logger							
		24.3	Data for info logger	14B	14B	15B	14B	14B	15B	9B
25.0	Customer no. (N° 1)			15	15	16	15	15	16	10
		25.1	Customer number (N° 2)	15B	15B	16A	15B	15B	16A	10A
		25.22	Puls value	16	16	17	16	16	17	11
		25.23	Nominal flow rate (qp)	17	17	18	17	17	18	12
26.0	Differential energy (dE)									
		26.1	Control energy (cE)							
27.0	Differential volume (vol d)									
		27.1	Control volume (vol c)							

¹ Depending on the selected depth of yearly and monthly logs in the programmable data logger, these display readings can be empty.

² The average is volume based

³ Only the date of min. /max is displayed in format 20xx.xx.xx. Serial reading includes the time (hh.mm) of the average value calculation too.

⁴ Inputs A and B are regularly updated in the display of MULTICAL® 603, i.e. the display of the connected water or electricity meter will be in accordance with the display of MULTICAL® 603 without delay.

⁵ The unit of this reading is fixed at kW.

3.2.5 Tariffs >EE<

MULTICAL® 603 has 3 extra registers TA2, TA3 and TA4, which can accumulate heat energy or cooling energy (EE=20 accumulates volume) parallel with the main register based on pre-programmed tariff conditions (to be stated when ordering the meter). Irrespective of the selected tariff type, the tariff registers are named TA2 TA3 and TA4 in the display.

As the main register is considered the legal billing register, it is accumulated no matter the selected tariff function. Tariff conditions TL2, TL3 and TL4 are monitored at every integration. If the tariff conditions are fulfilled, consumed heat energy is accumulated in either TA2, TA3 or TA4 parallel with the main register.

Example of power tariff (EE=11)

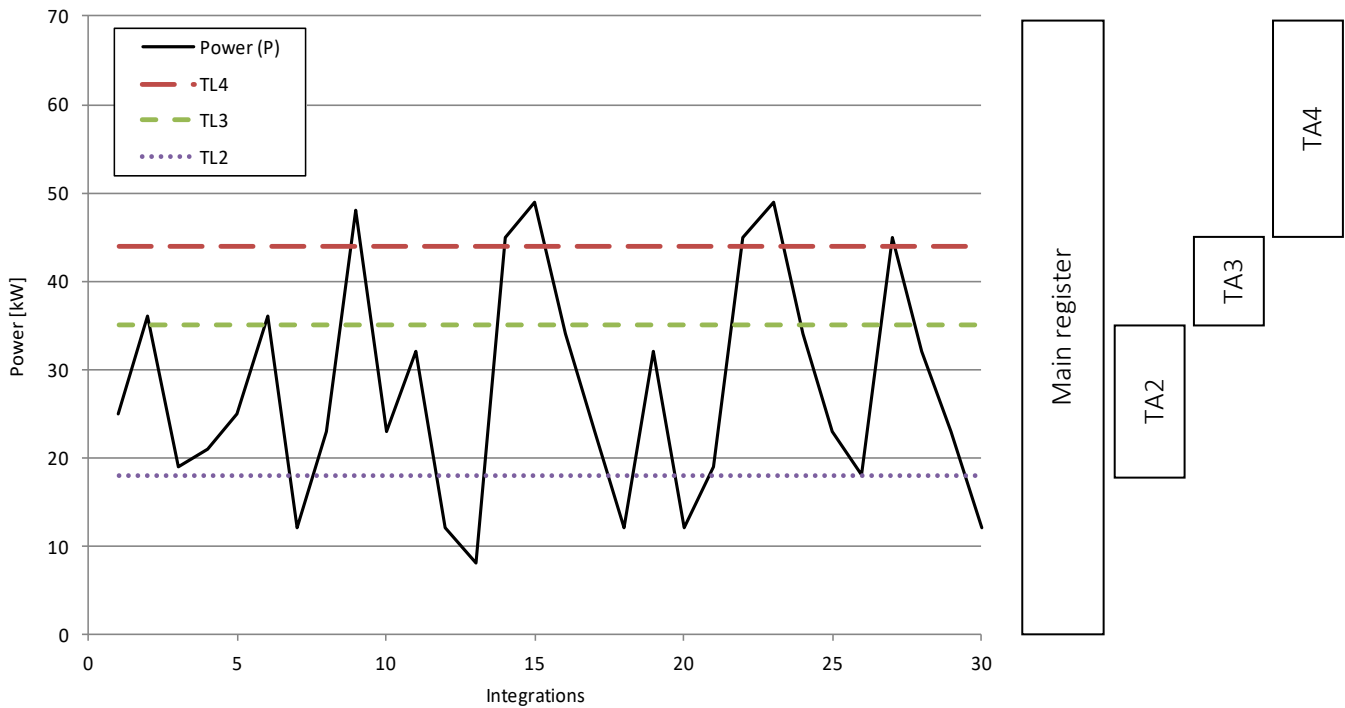

Three tariff conditions, TL2, TL3 and TL4, which are always used in the same tariff type, are connected to each tariff function. Therefore, it is not possible to “mix” two tariff types, except from the PQ tariff (EE=21).

TA2 shows energy consumed...

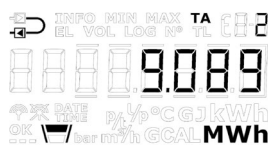

...above the power limit TL2

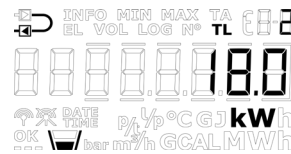

IMPORTANT: Out of consideration for backwards compatibility tariff register TA4 can be deactivated. Thus, the meter uses TA2 and TA3 only, and the tariff function works as in the previous model, MULTICAL® 602. TA4 is deactivated by setting the tariff limit TL4 at 0.

MULTICAL® 603

The below-mentioned table lists the tariff types, for which MULTICAL® 603 can be configured and shows the tariff types available for each meter type.

EE=	Tariff type	Function	Heat meter Meter type 2	Heat/cooling meter Meter type 3	Heat meter Meter type 4	Cooling meter Meter type 5	Heat/cooling meter Meter type 6	Volume meter Meter type 7
00	No active tariff	No function	•	•	•	•	•	•
11	Power tariff	Energy is accumulated in TA2, TA3 and TA4 on the basis of the power limits entered in TL2, TL3 and TL4	•		•	•		
12	Flow tariff	Energy is accumulated in TA2, TA3 and TA4 on the basis of the flow limits entered in TL2, TL3 and TL4	•		•	•		
13	t1-t2 tariff	Energy is accumulated in TA2, TA3 and TA4 on the basis of the Δt -limits entered in TL2, TL3 and TL4	•		•	•		
14	Inlet temperature tariff	Energy is accumulated in TA2, TA3 and TA4 on the basis of the t1-limits entered in TL2, TL3 and TL4.	•		•	•		
15	Outlet temperature tariff	Energy is accumulated in TA2, TA3 and TA4 on the basis of the t2-limits entered in TL2, TL3 and TL4.	•		•	•		
19	Time controlled tariff	TL2=Start time of TA2 TL3=Start time of TA3 TL4=Start time of TA4	•		•	•		
20	Heat/cooling volume tariff (TL2, TL3 and TL4 are not used)	Volume (V1) is divided into TA2 for heat ($t1 > t2$) and TA3 for cooling ($t1 < t2$). For heat/cooling meters, meter types 3 and 6, the energy accumulation also depends on Θ_{HC} (TA4 is not used in this tariff type).		•			•	•
21	PQ-tariff	Energy at $P > TL2$ is saved in TA2, and energy at $Q > TL3$ is saved in TA3	•		•	•		

EE=00 No active tariff

If no tariff function is required, you select the set-up EE=00.

The tariff function can, however, at a later stage be activated through reconfiguration via METERTOOL HCW. See Technical Description for METERTOOL HCW (5512-2097).

EE=11 Power-controlled tariff

If the actual power (P) exceeds TL2 but is lower than or equal to TL3, energy is counted in TA2 parallel to the main register. If the actual power exceeds TL3 but is lower than or equal to TL4, energy is counted in TA3 parallel to the main register. If the actual power exceeds TL4, energy is counted in TA4 parallel to the main register.

$P \leq TL2$	Accumulation in main register only	$TL4 > TL3 > TL2$
$TL3 \geq P > TL2$	Accumulation in TA2 and main register	
$TL4 \geq P > TL3$	Accumulation in TA3 and main register	
$P > TL4$	Accumulation in TA4 and main register	

Setting up data, TL3 must be higher than TL2 and TL4 must be higher than TL3.

The power controlled tariff is e.g. used as a basis for the individual heat consumer's connection fee. Furthermore, this tariff type can provide valuable statistical data if the heating station considers new construction activities.

EE=12 Flow controlled tariff

If the current water flow (Q) exceeds TL2 but is lower than or equal to TL3, energy is counted in TA2 parallel to the main register. If the current water flow exceeds TL3 but is lower than or equal to TL4, energy is counted in TA3 parallel to the main register. If the current water flow exceeds TL4, energy is counted in TA4 parallel to the main register.

$Q \leq TL2$	Accumulation in main register only	$TL4 > TL3 > TL2$
$TL3 \geq Q > TL2$	Accumulation in TA2 and main register	
$TL4 \geq Q > TL3$	Accumulation in TA3 and main register	
$Q > TL4$	Accumulation in TA4 and main register	

Setting up data, TL3 must be higher than TL2 and TL4 must be higher than TL3.

The flow controlled tariff is e.g. used as a basis for the individual heat consumer's connection fee. Furthermore, this tariff type can provide valuable statistical data if the heating station considers new construction activities.

When either power or flow tariff is used you obtain an overview of the total consumption compared to the part of the consumption used above tariff limits.

EE=13 t1-t2 tariff ($\Delta\theta$)

If the current t1-t2 ($\Delta\theta$) is lower than TL2 but exceeds or is equal to TL3, heat energy is counted in TA2 parallel to the main register. If the current cooling becomes lower than TL3 but is higher than or equal to TL4, energy is counted in TA3 parallel to the main register. If the current t1-t2 ($\Delta\theta$) is lower than TL4, energy is counted in TA4 parallel to the main register.

$\Delta\theta \geq TL2$	Accumulation in main register only	$TL4 < TL3 < TL2$
$TL3 \leq \Delta\theta < TL2$	Accumulation in TA2 and main register	
$TL4 \leq \Delta\theta < TL3$	Accumulation in TA3 and main register	
$\Delta\theta < TL4$	Accumulation in TA4 and main register	

Setting up tariff limits, TL3 must be lower than TL2 and TL4 must be lower than TL3.

The t1-t2 tariff can be used as a basis of weighted user charge. Low $\Delta\theta$ (small difference between inlet and outlet temperatures) is uneconomical for the heat supplier.

MULTICAL® 603

EE=14 Inlet temperature tariff

If the current inlet temperature (t_1) exceeds TL_2 but is lower than or equal to TL_3 , energy is counted in TA_2 parallel to the main register. If the current inlet temperature exceeds TL_3 but is lower than or equal to TL_4 , energy is counted in TA_3 parallel to the main register. If the current inlet temperature exceeds TL_4 , energy is counted in TA_4 parallel to the main register.

$t_1 \leq TL_2$	Accumulation in main register only	$TL_4 > TL_3 > TL_2$
$TL_3 \geq t_1 > TL_2$	Accumulation in TA_2 and main register	
$TL_4 \geq t_1 > TL_3$	Accumulation in TA_3 and main register	
$t_1 > TL_4$	Accumulation in TA_4 and main register	

Setting up data, TL_3 must be higher than TL_2 and TL_4 must be higher than TL_3 .

The inlet temperature tariff can be used as a basis for billing consumers who are guaranteed a certain inlet temperature. If the “guaranteed” minimum temperature is entered in TL_4 , the payable consumption is accumulated in TA_4 .

EE=15 Outlet temperature tariff

If the current outlet temperature (t_2) exceeds TL_2 , but is lower than or equal to TL_3 , energy is counted in TA_2 parallel to the main register. If the current outlet temperature exceeds TL_3 , but is lower than or equal to TL_4 , energy is counted in TA_3 parallel to the main register. If the current outlet temperature exceeds TL_4 , energy is counted in TA_4 parallel to the main register.

$t_2 \leq TL_2$	Accumulation in main register only	$TL_4 > TL_3 > TL_2$
$TL_3 \geq t_2 > TL_2$	Accumulation in TA_2 and main register	
$TL_4 \geq t_2 > TL_3$	Accumulation in TA_3 and main register	
$t_2 > TL_4$	Accumulation in TA_4 and main register	

Setting up data, TL_3 must be higher than TL_2 and TL_4 must be higher than TL_3 .

The outlet temperature tariff can be used as a basis of weighted user charge. A high outlet temperature indicates insufficient heat utilization which is uneconomical for the heat supplier.

EE=19 Time-controlled tariff

The time-controlled tariff is used for time division of heat consumption. If TL2 = 08:00, TL3 = 16:00 and TL4=23:00, the daily consumption from 08:00 until 15:59 is accumulated in TA2, whereas the consumption during the evening from 16:00 until 22:59 is accumulated in TA3, and the consumption during the night from 23:00 until 07:59 is accumulated in TA4.

TL2 must include fewer hours than TL3 and TL3 must include fewer hours than TL4.

From and incl. TL2 to TL3	Accumulation in TA2 and main register	TL3 must follow TL2 TL4 must follow TL3
From and incl. TL3 to TL4	Accumulation in TA3 and main register	
From and incl. TL4 to TL2	Accumulation in TA4 and main register	

The time-controlled tariff is suitable for billing in housing areas close to industrial areas with large district heating consumption as well as for billing industrial customers.

EE=20 Heat/cooling volume tariff

The heat/cooling volume tariff is used to divide volume into heat and cooling consumption in combined heat/cooling meters, i.e. the tariff divides the consumed volume into heat and cooling volume for combined heat/cooling meters. The total volume is accumulated in the register V1, whereas TA2 accumulates the volume consumed together with E1 (heat energy), and TA3 accumulates the volume consumed together with E3 (cooling energy).

EE=20 only functions in heat/cooling meters of the meter types 3 and 6.

(TA4 is not used in this tariff type).

$t1 > t2$ and $t1 \geq \theta_{hc}$	Volume is accumulated in TA2 and V1 (heat energy)	TL2 and TL3 are not used
$t1 > t2$ and $t1 \leq \theta_{hc}$	Volume is accumulated in V1 only	
$t2 > t1$ and $t1 \leq \theta_{hc}$	Volume is accumulated in TA3 and V1 (cooling energy)	
$t2 > t1$ and $t1 \geq \theta_{hc}$	Volume is accumulated in V1 only	
$t1 = t2$ and $t1 \geq \theta_{hc}$	Volume is accumulated in V1 only, no counting in energy registers	
$t1 = t2$ and $t1 \leq \theta_{hc}$	Volume is accumulated in V1 only, no counting in energy registers	

EE=21 PQ tariff

The PQ tariff is a combined power and flow tariff. TA2 functions as power tariff, and TA3 functions as flow tariff.

$P \leq TL2$ and $Q \leq TL3$	Accumulation in main register only	TL2 = power limit (P) TL3 = flow limit (Q)
$P > TL2$	Accumulation in TA2 and main register	
$Q > TL3$	Accumulation in TA3 and main register	
$P > TL2$ and $Q > TL3$	Accumulation in TA2, TA3 and main register	

The PQ tariff can e.g. be used for customers who pay a fixed charge based on max power and max flow (TL4 and TA4 are not used in this tariff type).

MULTICAL® 603

3.2.5.1 Tariff limits with Auto Detect of ULTRAFLOW® X4

Auto Detect enables the exchange of ULTRAFLOW® X4 on MULTICAL® 603 without changing the CCC code. MULTICAL® 603 can automatically adapt its CCC code to match the connected ULTRAFLOW® X4 via the function Auto Detect. Auto Detect is active with CCC code 8xx. Read more in paragraph 8.1.1.

The resolution of the tariff limits is adapted to the nominal flow q_p and is thus controlled by the selected CCC-code. The tariff limits do not change value at Auto Detect, but the resolution and the unit of the value may change. An example with flow-controlled tariff is shown below.

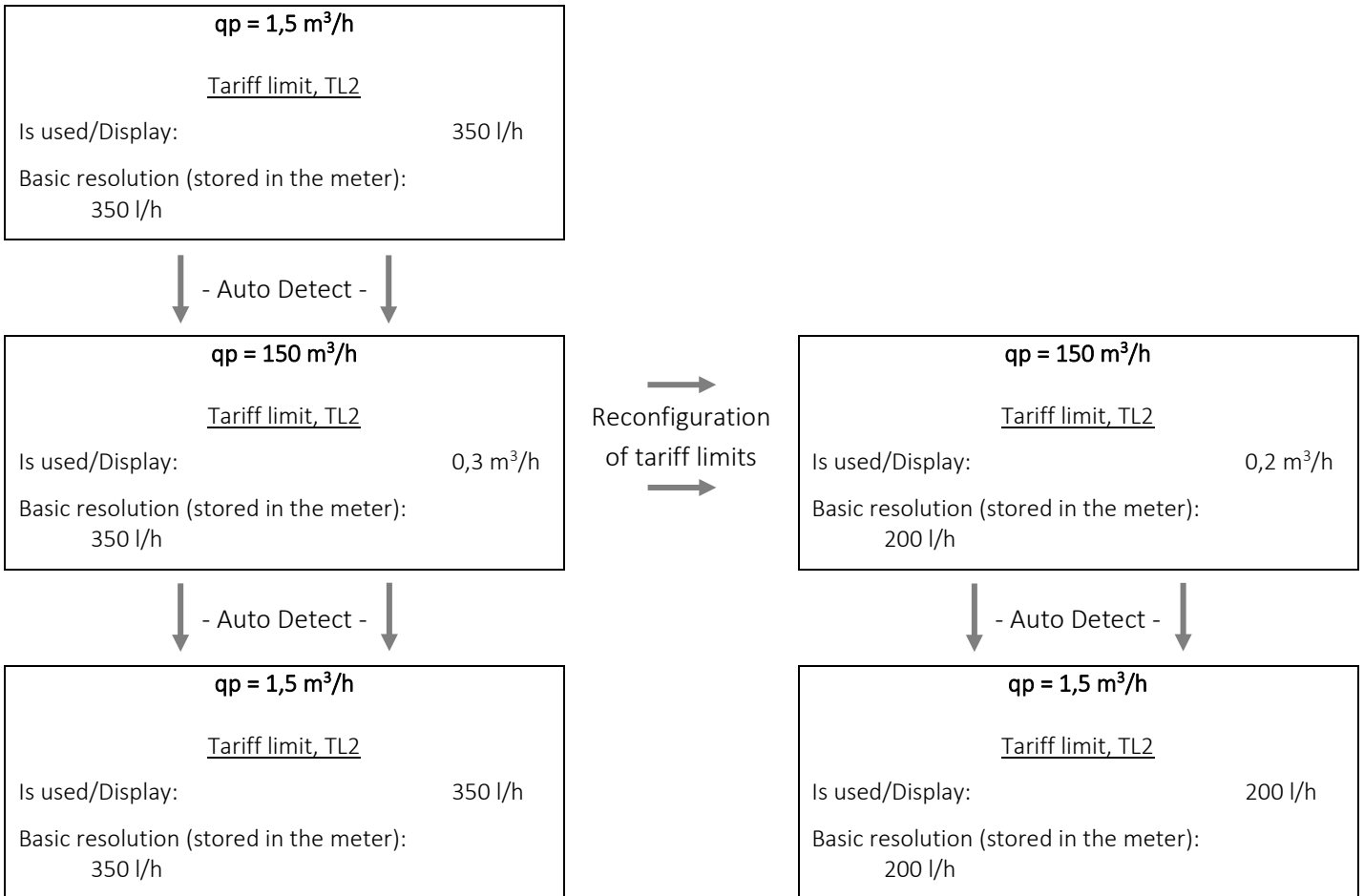

3.2.6 Pulse inputs A and B >FF-GG<

MULTICAL® 603 can have four extra pulse inputs (A1, A2, B1 and B2) which are placed on the communication modules (see paragraph 11 for further details on modules). The pulse inputs are used for acquisition and remote accumulation of pulses from e.g. mechanical water meters and electricity meters. The pulse inputs function independently of the meter itself. Therefore, they are not included in any energy calculation. The four pulse inputs are identically constructed and can be configured to receive pulses from water or electricity meters.

Pulse inputs A and B are placed on selected communication modules. If the module is installed in module slot 1 of MULTICAL® 603, the inputs A1 and B1 are identified, and likewise for module slot 2; A2 and B2.

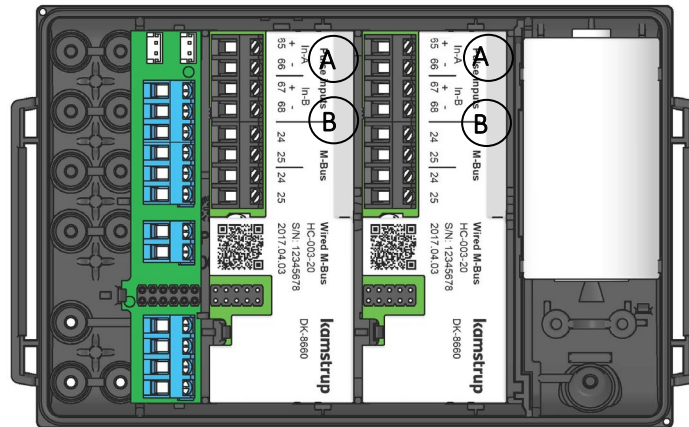

Note:

The pulse inputs A1 and A2 are always identically configured through the FF code, and the inputs B1 and B2 are likewise always identically configured through the GG code. Therefore, pay special attention to this when the modules are installed in the meter, so that they are installed in the correct module slot in regard to the equipment they are to be connected to.

All modules with Pulse inputs are clearly marked with this.



Terminals for In- A and terminals for In-B are marked as well.

See chapter 11.2 for more details about the available modules.

MULTICAL® 603

MULTICAL® 603 registers the accumulated consumption of the meters connected to the inputs and saves the counter values every month and every year on target date. The number of these yearly and monthly loggings depends on the selected logger profile (RR-code). Read more about data logger profiles in paragraph 3.2.11. In order to facilitate the identification during data reading, it is also possible to save the meter numbers of the four meters connected to the inputs. The meter numbers can either be programmed in the meter via the "SETUP loop" (for A1 and B1) or via METERTOOL HCW (for A1, B1, A2 and B2).

Note:

The selected datagram profile of the module, configured through the module's ZZZ code, controls which pulse input registers are collected through the module. By default, In-A1 and In-B1 are collected.

Two alarm types are connected to the pulse inputs, cold water leakage and external alarm, respectively. Unless otherwise informed by the customer, the meter is by default prepared for external alarm on all four inputs from the factory, but only with active leakage alarm on input A1 and A2 (like in MC602). Please contact Kamstrup A/S if you need leakage alarm possibility on input B1 and B2. Read more about cold water leakage in paragraph 3.2.9 and more about info codes in paragraph 7.7.

Requirements for equipment attached to the pulse inputs:

Pulse inputs A and B	Electronic switch	Reed switch
Pulse input	680 kΩ pull-up to 3,6 V	680 kΩ pull-up to 3,6 V
Pulse ON	< 0,4 V for > 30 ms	< 0,4 V for > 500 ms
Pulse OFF	> 2,5 V for > 30 ms	> 2,5 V for > 500 ms
Pulse frequency	< 3 Hz	< 1 Hz
Electrical isolation	No	No
Max cable length	25 m	25 m
Requirements to external	Leakage current at function open < 1 μA	
Update of display	Follows the selected integration interval (from 2 to 64 s)	

The pulse inputs are placed on the module with the following terminal numbering:

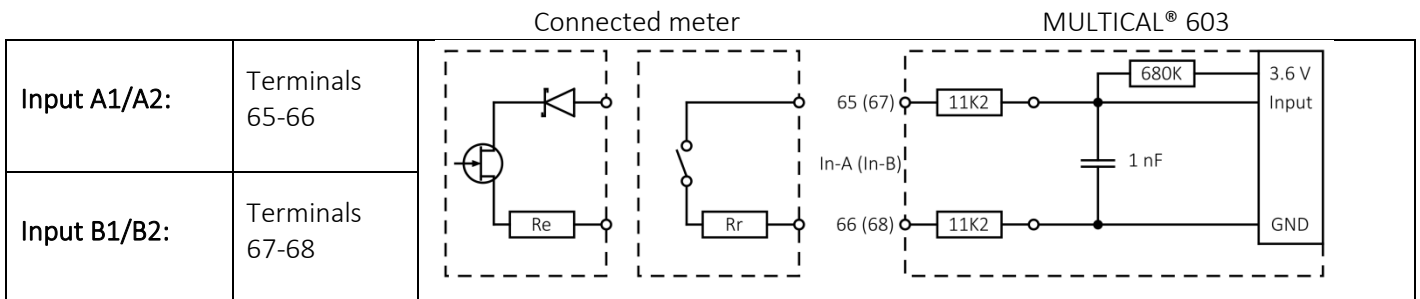

The pulse inputs are configured as a part of the meter's configuration number via the FF and GG codes. Upon receipt of order, the FF and GG codes are configured at 24 by default (unless otherwise informed by the customer). Valid FF and GG codes appear from the table below. The default code 24 is marked in green. The FF and GG codes can be reconfigured by means of METERTOOL HCW. See Technical Description for METERTOOL HCW (5512-2097).

Input A1/A2		Input B1/B2		Pre-counter ²	Wh/imp	l/imp	Measuring unit and decimal place	
FF-code	Max flow water meter	GG-code	Max flow water meter					
01	100 m ³ /h	01	100 m ³ /h	1	-	100	vol A/vol b (m ³)	000000,0
02	50 m ³ /h	02	50 m ³ /h	2	-	50	vol A/vol b (m ³)	000000,0
03	25 m ³ /h	03	25 m ³ /h	4	-	25	vol A/vol b (m ³)	000000,0
04	10 m ³ /h	04	10 m ³ /h	10	-	10	vol A/vol b (m ³)	000000,0
05	5 m ³ /h	05	5 m ³ /h	20	-	5	vol A/vol b (m ³)	000000,0
06	2,5 m ³ /h	06	2,5 m ³ /h	40	-	2,5	vol A/vol b (m ³)	000000,0
07	1 m ³ /h	07	1 m ³ /h	100	-	1	vol A/vol b (m ³)	000000,0
24	10 m ³ /h	24	10 m ³ /h	1	-	10	vol A/vol b (m ³)	00000,00
25	5 m ³ /h	25	5 m ³ /h	2	-	5	vol A/vol b (m ³)	00000,00
26	2,5 m ³ /h	26	2,5 m ³ /h	4	-	2,5	vol A/vol b (m ³)	00000,00
27	1 m ³ /h	27	1 m ³ /h	10	-	1	vol A/vol b (m ³)	00000,00
40	1000 m ³ /h	40	1000 m ³ /h	1	-	1000	vol A/vol b (m ³)	0000000
FF-code ¹	Max power Electricity meter	GG-code	Max power Electricity meter	Pre-counter ²	Wh/imp	l/imp	Measuring unit and decimal place	
50	2500 kW	50	2500 kW	1	1000	-	EL A/EL b (kWh)	0000000
51	150 kW	51	150 kW	60	16,67	-	EL A/EL b (kWh)	0000000
52	120 kW	52	120 kW	75	13,33	-	EL A/EL b (kWh)	0000000
53	75 kW	53	75 kW	120	8,333	-	EL A/EL b (kWh)	0000000
54	30 kW	54	30 kW	240	4,167	-	EL A/EL b (kWh)	0000000
55	25 kW	55	25 kW	340	2,941	-	EL A/EL b (kWh)	0000000
56	20 kW	56	20 kW	480	2,083	-	EL A/EL b (kWh)	0000000
57	15 kW	57	15 kW	600	1,667	-	EL A/EL b (kWh)	0000000
58	7,5 kW	58	7,5 kW	1000	1	-	EL A/EL b (kWh)	0000000
59	750 kW	59	750 kW	10	100	-	EL A/EL b (kWh)	0000000
60	2500 kW	60	2500 kW	2	500	-	EL A/EL b (kWh)	0000000
61	75 kW	61	75 kW	100	10	-	EL A/EL b (kWh)	0000000
62	15 kW	62	15 kW	500	2	-	EL A/EL b (kWh)	0000000
70	25000 kW	70	25000 kW	1	10000	-	EL A/EL b (MWh)	00000,00

Inputs for external alarm:

98		98		External alarm input; Alarm=LO (normally open)
99		99		External alarm input; Alarm=HI (normally closed)

¹ **Note:** If pulse input In-A1 or In-A2 is used for counting of energy from an electricity meter, this value will not be readable via M-Bus, see further information about the location of pulse inputs at the beginning of this paragraph.

² **Note:** Pre-counter is the needed number of pulses to increment the display.

MULTICAL® 603

The registers which are connected to the pulse inputs can be read in the meter's "TECH loop", "USER loop" (depending on selected DDD code) and via data communication. In addition, it is possible to preset the meter count of the four pulse inputs at the values of the connected meters at the time of commissioning. This can either be carried out via the meter's "SETUP loop" (for A1 and B1) or via METERTOOL HCW (for A1, B1, A2 and B2).

Input A1	
Counter value	
Meter No. A1	
L/imp. for A1	
Yearly date	
Yearly data	
Monthly date	
Monthly data	

Input B1	
Counter value	
Meter No. B1	
Wh/imp. for B1	
Yearly date	
Yearly data	
Monthly date	
Monthly data	

3.2.7 Integration mode >L<

MULTICAL® 603 uses time-based integration, which means that accumulated volume and energy are calculated at fixed, or variable, time intervals. The time interval is configurable via the L-code and independent of the water flow speed. Please be aware that choice of integration mode in combination with selected power supply defines the meter's battery lifetime. Please see paragraph 10.4 regarding the meter's battery lifetime.

It is possible to choose between seven integration modes; four modes where the meter's display remains turned on, and three modes where the meter's display is turned off 8 min. after the latest registered activation of a key (4 min. after the latest registered activation of the key, the meter returns to its first primary reading, and after additional 4 min., the display turns off). In periods with the display switched off, a display segment flashes at an interval of 30 s to indicate that the meter is active ("heart beat" indication).

MULTICAL® 603 can be ordered with a backlit display (meter type 603-F). The backlight is activated by pushing a button and remains on for 15 seconds.

Integration mode	Backlight period (only 603-F)	L-code	
		Display on	Display off
Adaptive mode (2-64 s)	15 s.	1	5
Normal mode (32 s)	15 s.	2	6
Fast mode (8 s)	15 s.	3	7
Fast mode (2 s)	15 s.	4	-

Note: Activating a key on the display changes the time interval to 2 seconds regardless of integration mode.

4 minutes after the latest registration of a key, the time interval returns to the interval based on the integration mode.

MULTICAL® 603

Adaptive mode (2-64 s)

Adaptive mode is the meter's intelligent integration mode, in which the time interval is currently adjusted. This mode combines the long battery lifetime obtained in Normal mode with the high measuring and calculation resolution obtained in Fast mode.

When the thermal system is stable, i.e. runs at stable flow and power, the meter will use a time interval of 64 s. MULTICAL® 603 continuously measures if flow and power have changed, and if this is the case, reduces the interval. Depending on the change, the meter can reduce the integration interval to 2 seconds, which means that the meter calculates accumulated volume and energy every 2 seconds. Thereby, higher resolution and higher precision are obtained during periods with changes in the system. MULTICAL® 603's adaptive algorithm reacts to flow changes down to 1 %.

For applications with two flow sensors, it is worth noting that MULTICAL® 603 only measures changes in flow and power of V1 and not of both V1 and V2. This means that the integration of registers related to V1 and V2, respectively takes place at the same time and is time-based. In adaptive mode, the integration interval is only adjusted according to the changes of V1.

When the system is stable, the meter gradually returns to the 64 s. interval. MULTICAL® 603 reacts quickly to changes in the system by lowering the time interval; however, it gradually returns to the time interval of 64 s. as the system becomes stable. This is illustrated in the figure below.

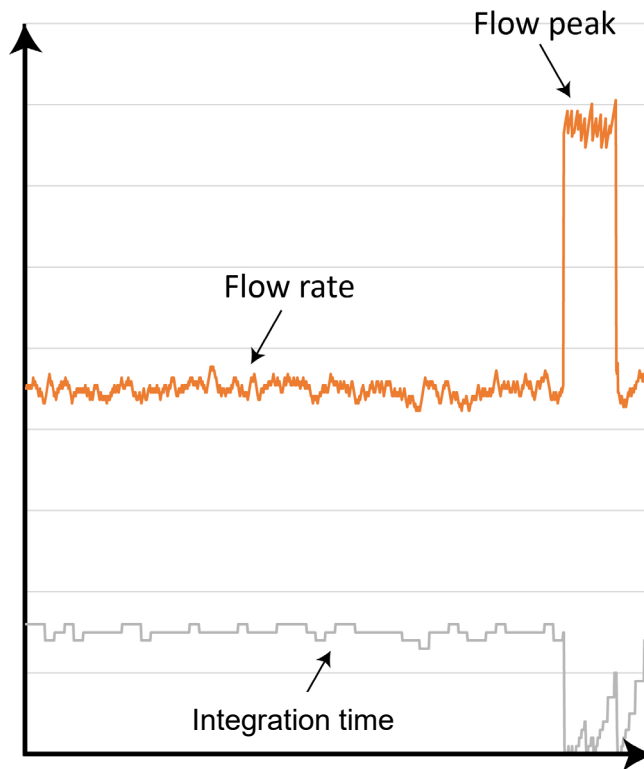

Thus, in adaptive mode MULTICAL® 603 measures at high resolution during periods with changes in the system requiring accurate measurements and saves battery power during periods with no changes in the thermal system.

Adaptive mode is recommended for all systems including those with tap water exchanger.

Normal mode (32 s)

In normal mode the integration interval is set at 32 seconds, which means that the meter calculates accumulated volume and energy every 32 seconds.

Normal mode is recommended for systems with hot water tank and similar systems in which changes are not taking place too quickly.

Fast mode (8 s)

In fast mode (8 s) the integration interval is set at 8 seconds, which means that the meter calculates accumulated volume and energy every 8 seconds.

Fast mode (8 s) is recommended for all systems including those with tap water exchanger.

Fast mode (2 s)

In fast mode (2 s), the integration interval is set at 2 seconds, which means that the meter calculates accumulated volume and energy every 2 seconds.

Fast mode (2 s) is recommended for all systems including those with tap water exchanger. Fast mode is especially suitable for applications in which the meter is equipped with analog outputs. Together with ULTRAFLOW® X4, fast mode (2 s) meet the requirements for "Fast response meter" in EN 1434.

Battery lifetime is typically 14 years in Fast mode (2 s) with 1 x D cell. Read more in paragraph 10.4 Battery lifetimes.

Integration concept

The integration concept for MULTICAL® 603 is illustrated in the figure below.

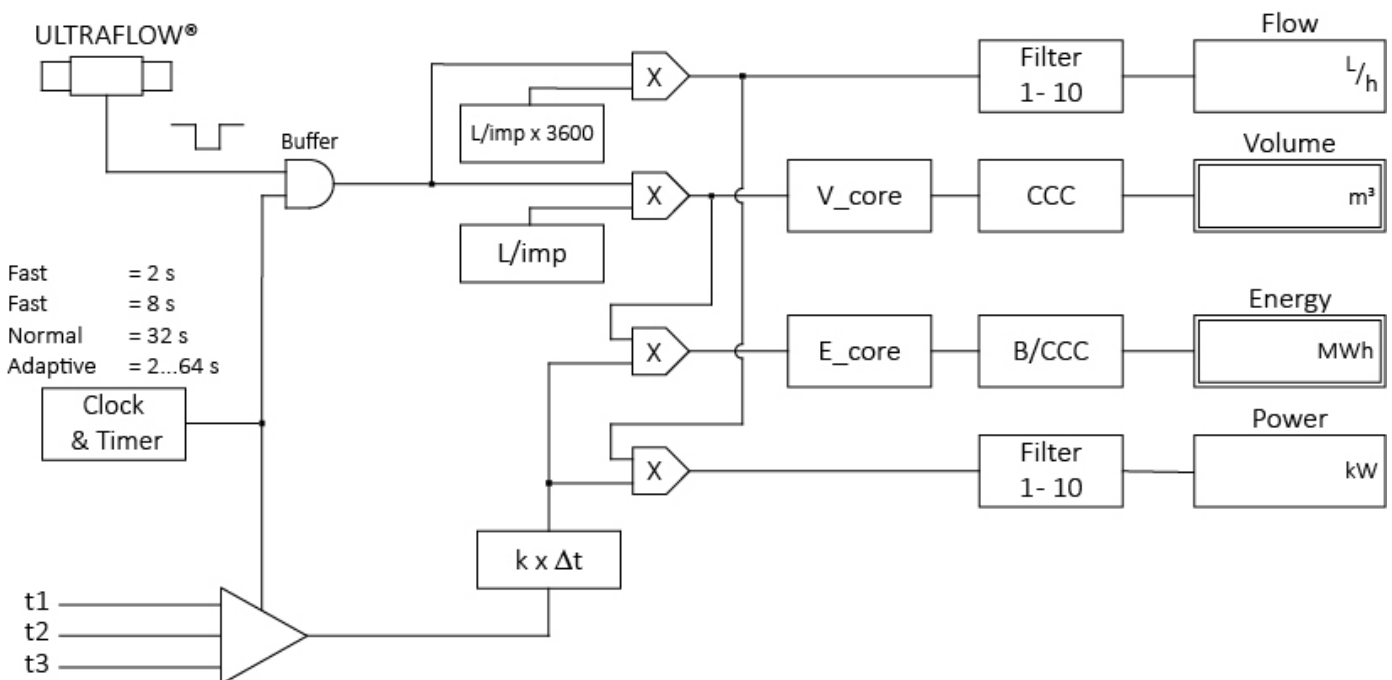

Filter value

Filters 1-10 are used to change the filter value of actual flow and actual power. The filter value influences the actual flow and actual power readings on the display, on the data readout and on the analog outputs. With this filter setting, an averaging of actual flow and actual power of up to 10 x the integration time can be achieved. See the below curves for the effect of different filter values on the same fluctuating flow rate:

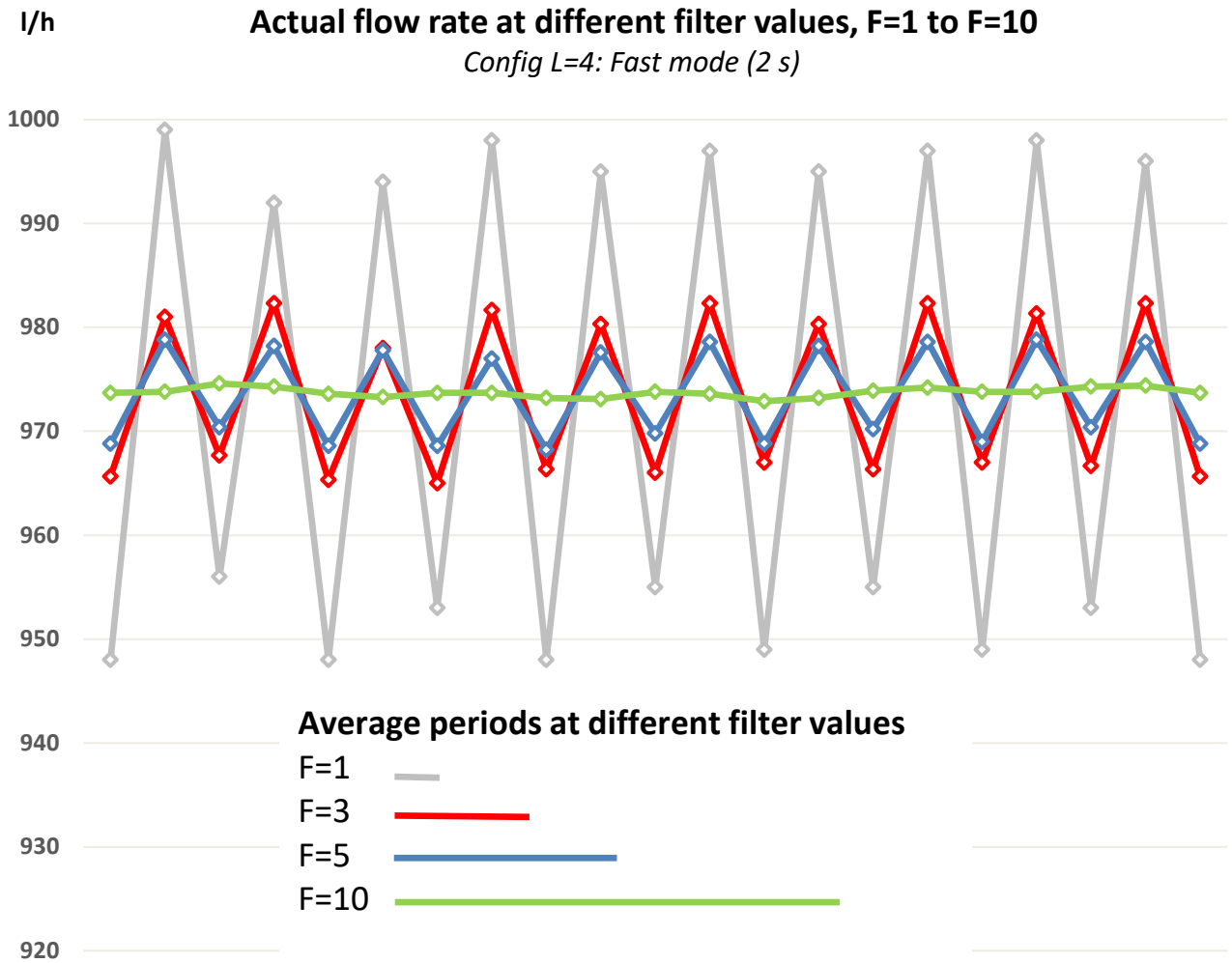

The averaging time at different filter values and integration modes is shown in the table below. Please note that the response time is equal to the chosen integration mode (e.g. 2 s for Fast mode (2 s)), but the higher the filter value, the less change per integration period is shown.

Integration mode	Filter value			
	F=1	F=3	F=5	F=10
Fast mode (2 s)	2 s	6 s	10 s	20 s
Fast mode (8 s)	8 s	24 s	40 s	80 s
Normal mode (32 s)	32 s	96 s	160 s	320 s
Adaptive mode (2-64 s)	2-64 s	6-192 s	10-320 s	20-640 s

When using Fast mode and F=5, the meter calculates the average value every 2 seconds based on values from the last 10 seconds. The display is still updated and data is provided for the communication modules every 2 seconds. The factory setting is F=5 for meters produced from July 2021. Previously produced meters have factory setting F=3. If another filter value is needed, this value can be changed using METERTOOL.

The screenshot shows the METERTOOL HCW software interface for configuring a MULTICAL® 603M meter. The interface is divided into a left sidebar with navigation options and a main configuration area. The 'Filter value' field at the bottom of the configuration area is highlighted with a red box and contains the value '5'. Other configuration parameters include Customer No. (10101010), Type No. (603), Config No. 1 (4), Config No. 2 (00), Config No. 3 (0), Config No. 4 (0000), qp (0.6), Yearly target date 1 (01/01), Monthly target date 1 (01), Yearly target date 2 (00/00), Monthly target date 2 (00), Min/Max for P and Q (0015), CP avg. time (07), Heat/Cooling Change Over (250.00), Secondary MBus address (10101010), t2 preset (250.00), t3 preset (250.00), t4 preset (005.00), t5 preset (050.00), Tariff limit 2 (0), Tariff limit 3 (0), Tariff limit 4 (0), T offset (0.00), and Fluid type code (5).

MULTICAL® 603

3.2.8 Leakage limits (V1, V2) >M<

MULTICAL® 603 can be used for leakage monitoring when two flow sensors are connected to MULTICAL® 603 on the inputs V1 and V2. Note that it is only possible to connect two flow sensors on the calculator types 603-E/F. See the type number overview in paragraph 3.1.

The M code defines the leakage limit, i.e. the sensitivity of the leakage monitoring. If a leakage is detected in the system, an info code indicating leakage or burst is activated, depending on the size of the leakage. The leakage search is based on a difference in mass (ΔMass) between the calculated mass of V1 and V2, respectively. The calculation of this mass difference is performed over 24 hours, the response time of the info code indicating a leakage thus being 24 hours. The burst search is based on a difference in flow of V1 and V2, respectively. The burst search is performed over a period of 120 s. Read more about these info codes in the info code overview in paragraph 7.7.

The sensitivity of a leakage can be adjusted via the M-code, whereas the sensitivity of a burst is clearly defined. This also appears from the table of the M-code below. It is possible to detect leakages down to 15 kg/h through the connection of the two flow sensors of q_p 1,5 m³/h. Both info codes for leakage and burst can be deactivated via the M-code (M = 0).

Leakage limits (V1, V2)		M-code
Leakage	Burst	
No active leak search	No active burst search	0
$\Delta\text{Mass} \approx > 1,0 \% \text{ of } q_p + 20 \% q$	$\Delta\text{flow} > 20 \% \text{ of } q_p$	1
$\Delta\text{Mass} \approx > 1,0 \% \text{ of } q_p + 10 \% q$	$\Delta\text{flow} > 20 \% \text{ of } q_p$	2
$\Delta\text{Mass} \approx > 0,5 \% \text{ of } q_p + 20 \% q$	$\Delta\text{flow} > 20 \% \text{ of } q_p$	3
$\Delta\text{Mass} \approx > 0,5 \% \text{ of } q_p + 10 \% q$	$\Delta\text{flow} > 20 \% \text{ of } q_p$	4

Leakage limit for q_p 1,5 m³/h
M-kode = 2 (1,0% af q_p + 10% q)

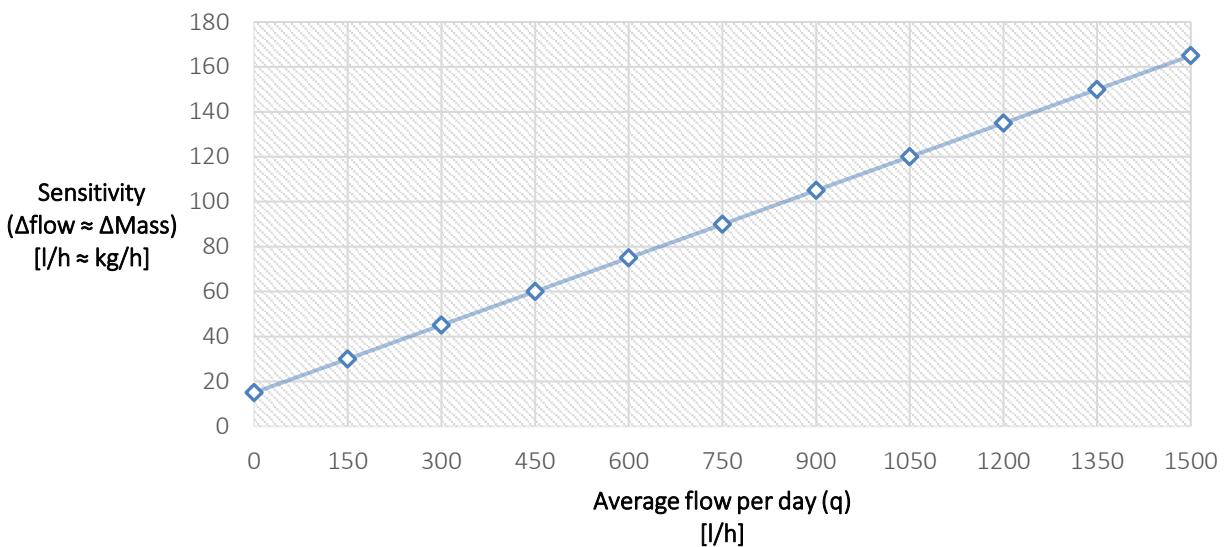

Permanent operational monitoring

Leakage monitoring can with advantage be extended to include permanent operational monitoring as it just requires the installation of a set of three sensors instead of a sensor pair. In Denmark, for example, the permanent operational monitoring reduces the number of random samples to three meters per random sampling lot, regardless of the size of the measuring lot. Read more in the installation guide for permanent operational monitoring (Kamstrup guide 5512-1486_GB). The purpose of these instructions is to provide caretakers, installers and consulting engineers with the information needed about Kamstrup's leakage monitoring system and permanent operational monitoring.

3.2.9 Cold water leakage (In-A, In-B) >N<

The pulse inputs A and B of MULTICAL® 603 can be used for cold water leakage monitoring. Basically, however, cold water leakage monitoring is only active on input A (A1/A2), unless otherwise agreed with the customer. When MULTICAL® 603 is used for leak monitoring, the sensitivity is determined by the configuration of the N-code.

Leakage monitoring is measured over a period of 24 hours. The N code defines the resolution by which the 24 hours are divided; either 48 intervals of half an hour, 24 intervals of one hour or 12 intervals of two hours. If the meter registers minimum one pulse during each of these intervals over the full period, info code 8, which indicates leakage, is activated. The info code is not activated until after the 24-hour period, however it is reset again as soon as the meter registers an interval without pulses.

The table below shows the three available N-codes. Upon receipt of order the N-code is configured at 2 by default (unless otherwise informed by the customer).

Cold water leakage search (In-A1/A2)	N-code
No active leak search	0
30 min. without pulses	1
One hour without pulses	2
Two hours without pulses	3

3.2.10 Pulse outputs C and D >PP<

MULTICAL® 603 can have up to four pulse outputs (C1, C2, D1 and D2) which are placed on the communication modules (see paragraph 11 for further details on modules). The pulse outputs have three application options:

- The sending of selected meter count registers (which are determined by the selected country code).
- Controlled output, which means that the pulse outputs can be controlled by data commands.
- Pulse transmitter/divider so that the pulse signal from V1 and V2 is sent via the pulse outputs.

Pulse outputs C and D are placed on selected communication modules. If the module is installed in module slot 1 of MULTICAL® 603, the outputs C1 and D1 are identified, and likewise for module slot 2; C2 and D2.

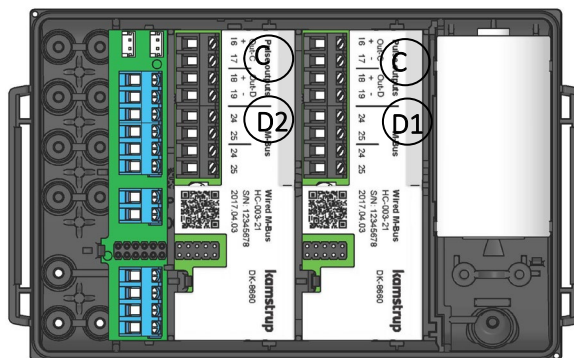

Note:

The pulse outputs C1 and C2 are always configured identically, and likewise, the outputs D1 and D2 are always configured identically. All four outputs are configured through the meter's PP code. Therefore, pay special attention to this when the modules are installed in the meter, so that they are installed in the correct module slot in regard to the equipment they are to be connected to.

MULTICAL® 603

All modules with pulse outputs are clearly marked.

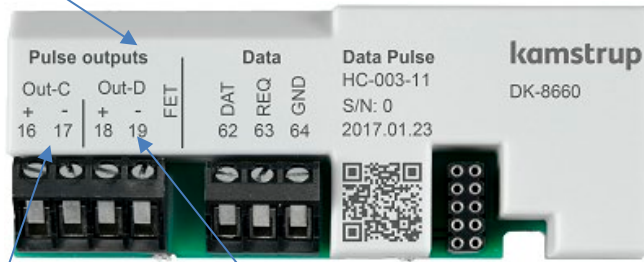

Terminals for Out-C and terminals for Out-D are marked as well. See chapter 11.2 for more details about the available modules.

Technical data for Pulse outputs

Output type	Opto FET
External voltage	1...48 VDC/AC
Current	< 50 mA
On-resistance	≤ 40 Ω
Electric isolation	2 kV
Max. cable length	25 m

Please note the polarity when making the connection. The pulse outputs are placed on the module with the following terminal numbering:

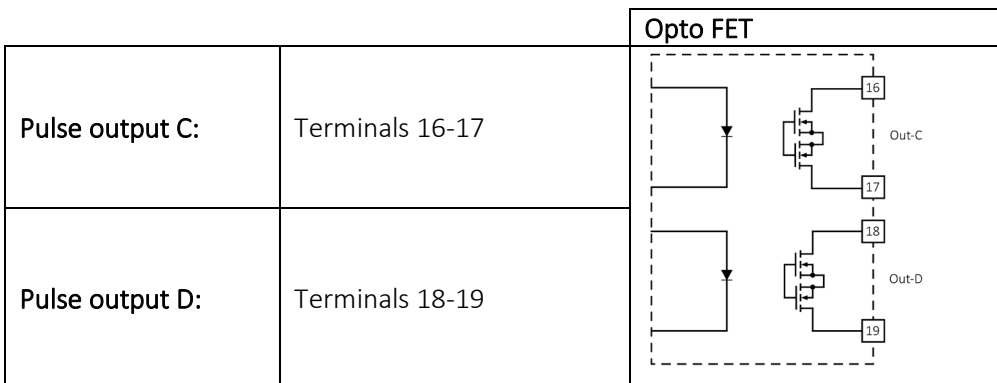

Note. For specifications on previous versions of pulse outputs, see "Electrical Data" in paragraph 2.4

The pulse outputs are configured as part of the meter's configuration number via the PP code. Upon receipt of order the PP-code is configured at 95 by default (unless otherwise informed by the customer). Valid PP-codes appear from the table below. The default code 95 is marked in green. It is possible to reconfigure the PP code by means of METERTOOL HCW. See Technical Description of METERTOOL HCW (5512-2097).

Pulse outputs C and D	PP-code
Pulse transmitter/divider	
Out-C: V1/4 (5 ms)	73
Out-C: V1/1, Out-D: V2/1 (3,9 ms)	80
Out-C: V1/1 (3,9 ms)	82
Out-C: V1/4 (22 ms)	83
Meter count registers	
10 ms	94
32 ms	95
100 ms (0,1 s)	96
Output controlled by data commands	
Controlled output	99

Pulse transmitter/divider

The meter can be configured in such a way that the pulse outputs serve as either pulse transmitters or pulse dividers. If the outputs are to serve as pulse transmitters, the meter's PP-code is configured to either 80 or 82. Irrespective of whether both outputs are connected or floating, the PP-code 80 with pulse transmitter on both Out-C and Out-D results in an increased power consumption. Therefore, mains supply is recommended when configuring the PP-code 80. If the outputs are to serve as pulse dividers, the meter's PP-code is configured to 83 with 22 ms pulse duration or PP code 73 with 5 ms pulse duration.

The function pulse transmitter/divider can be used for, among other things, external leakage protection, the possibility of connecting an additional calculator to the same flow sensor and for external control systems that regulates according to flow pulses, for example Siemens RVD 250 and Danfoss ECL 310, both of which can use the PP code 73 with 5 ms pulse width.

Pulse output with meter count registers

As previously described, the outputs are configured in pairs (C1/C2) and (D1/D2), which means that it is possible to send output from two of the following meter count registers on pulse output C1/C2 and pulse output D1/D2, respectively:

- E1 (Heat energy)
- E3 (Cooling energy)
- V1 (Volume)

Note: As the selected meter count registers are configured by the country code, the configuration cannot be changed after delivery.

Pulse outputs are by default configured with the following registers:

Meter function	Out-C1/C2	Out-D1/D2	Meter type
Heat meter	E1 (CE+)	V1 (CV)	1, 2, 4
Heat/cooling meter	E1 (CE+)	E3 (CE-)	3, 6
Cooling meter	E3 (CE-)	V1 (CV)	5
Volume meter	V1 (CV)	V1 (CV)	7

MULTICAL® 603

The resolutions of the pulse outputs always follow the least significant digit in the display, which is determined by the CCC code (see paragraph 3.2.3). The following table shows examples for a heat meter.

CCC	qp	Imp./L	7/8 digits	Number of decimals in display								Connection type
				kWh	MWh Gcal	GJ	m ³ ton	l/h	m ³ /h	kW	MW	
119	1,5	100	7	0	3	2	2	0	-	1	-	C-P
479	25	6	7	-	2	1	1	-	2	0	-	1-2-7-8
480	100	1,5	7	-	1	0	0	-	2	0	-	1-2-7-8

CCC code 119: Output CE = 1 pulse/1 kWh Output CV = 1 pulse/0,01 m³

CCC code 479: Output CE = 1 pulse/10 kWh Output CV = 1 pulse/0,1 m³

CCC code 480: Output CE = 1 pulse/100 kWh Output CV = 1 pulse/1 m³

Be aware that the pulses are accumulated in the integration interval and sent at every integration at a fixed frequency. This is shown in the example below.

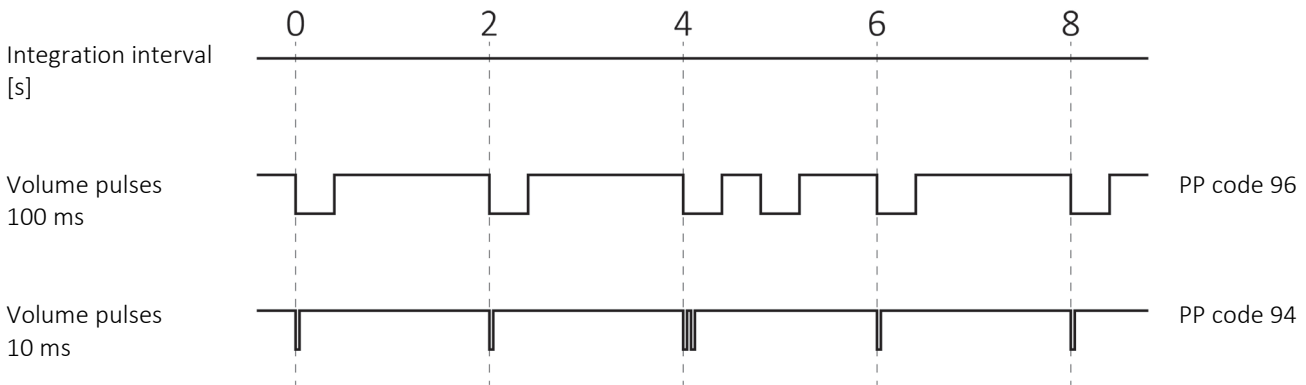

Controlled output

The meter can be configured for data command control of pulse outputs. If controlled output is required, the PP-code is to be configured at 99. As previously described, the outputs are configured in pairs (C1/C2) and (D1/D2), which means that connected external equipment can switch the meters' outputs, in the pairs C1/C2 and D1/D2, OFF (open opto-transistor output) and ON (closed opto-transistor output) respectively via KMP data commands.

Output status can be read via the KMP-registers and after a power-on reset the outputs will have the same status as before the power failure as every change of status is saved in the meter's EEPROM.

3.2.11 Data logger profile >RR<

MULTICAL® 603 has a permanent memory (EEPROM), in which the results from various data loggers are saved. The data logger is programmable. The required data logger profile is selected via the RR-code of the configuration number. Unless otherwise stated by the customer, the RR-code is set to 10, which is a default data logger profile. If data logging of other registers, different intervals and logging depths are required, other data logging profiles can be composed to match individual requirements.

The programmable data logger includes the following six data loggers:

- Yearly logger
- Monthly logger
- Daily logger
- Hourly logger
- Minute logger1
- Minute logger2

Note:

When the module's datagram is configured via the module's ZZZ-code, it is important that the necessary registers, which are to be transmitted via the datagram, are also available in the meter. Therefore, there must be consistency between the choice of RR-code in the meter and the ZZZ-code in the module.

Please contact Kamstrup A/S for further information.

Both data logger registers and logging depths are programmable, and individual logging profiles can be combined as required by the customer. Below is an example of a logger profile (RR-code=10), which is based on, but not identical to the logger in MULTICAL® 602.

Logger type		Year	Month	Day	Hour	Minute 1	Minute 2
Logging interval		-	-	-	-	15m	1m
Logging depth		20	36	460	1400	0	0
Date (YY.MM.DD)	Year, month and day of logging time.	x	x	x	x	x	x
Clock (hh.mm.ss)	Time	x	x	x	x	x	x
E1	E1 = V1(t1-t2)k Heat energy	x	x	x	x		
E2	E2 = V2(t1-t2)k Heat energy	x	x				
E3	E3 = V1(t2-t1)k Cooling energy	x	x	x	x		
E4	E4 = V1(t1-t3)k Inlet energy	x	x				
E5	E5 = V2(t2-t3)k Outlet energy or tap from outlet	x	x				
E6	E6 = V2(t3-t4)k Tap water energy, separate	x	x				
E7	E7 = V2(t1-t3)k Tap water energy from inlet	x	x				
E8	E8 = m3 x t1 (inlet)	x	x				
E9	E9 = m3 x t2 (outlet)	x	x				
E10	E10 = t3 x V1	x	x				
E11	E11 = t3 x V2	x	x				
ΔE	Differential energy						
cE	Control energy						
A1	Heat energy with discount						
A2	Heat energy with surcharge						

Logger type		Year	Month	Day	Hour	Minute 1	Minute 2
TA2	Tariff register 2	x	x				
TA3	Tariff register 3	x	x				
TA4	Tariff register 4	x	x				
V1	Volume register for Volume 1	x	x	x	x		
V2	Volume register for Volume 2	x	x	x	x		
ΔV	Differential volume						
cV	Control volume						
In-A1	Extra water meter connected to Input A1	x	x	x	x		
In-B1	Extra water or electricity meter connected to Input B1	x	x	x	x		
In-A2	Extra water meter connected to Input A2	x	x	x	x		
In-B2	Extra water or electricity meter connected to Input B2	x	x	x	x		
M1	Mass corrected V1	x	x	x	x		
M2	Mass corrected V2	x	x	x	x		
INFO	Information code	x	x	x	x		
Flow1MaxDate Year	Date stamp for max flow V1 for the year	x					
Flow1Max Year	Value of max Flow V1 for the year	x					
Flow1MinDate Year	Date stamp for min. flow V1 for the year	x					
Flow1Min Year	Value for min. Flow V1 for the year	x					
Power1MaxDate Year	Date stamp for max power for the year	x					
Power1Max Year	Value of max power for the year	x					
Power1MinDate Year	Date stamp for min. power for the year	x					
Power1Min Year	Value for min. power for the year	x					
Flow1MaxDate Month	Date stamp for max flow V1 for the month		x				
Flow1Max Month	Value of max Flow V1 for the month		x				
Flow1MinDate Month	Date stamp for min. flow V1 for the month		x				
Flow1Min Month	Value for min. Flow V1 for the month		x				
Power1MaxDate Month	Date stamp for max power for the month		x				
Power1Max Month	Value for max power for the month		x				
Power1MinDate Month	Date stamp for min. power for the month		x				
Power1Min Month	Value for min. power for the month		x				
COP Year (SCOP)	Coefficient Of Performance, year						
COP Month	Coefficient Of Performance, month						
t1TimeAverage Day	Time average (day) of t1						
t2TimeAverage Day	Time average (day) of t2						
t3TimeAverage Day	Time average (day) of t3						
t1TimeAverage Hour	Time average (hour) of t1						
t2TimeAverage Hour	Time average (hour) of t2						
t3TimeAverage Hour	Time average (hour) of t3						
P1AverageDay	Time averaged analog input (day) of P1						
P2AverageDay	Time averaged analog input (day) of P2						
P1AverageHour	Time averaged analog input (hour) of P1						
P2AverageHour	Time averaged analog input (hour) of P2						
HourCounter	Accumulated number of operating hours	x	x				

Logger type		Year	Month	Day	Hour	Minute 1	Minute 2
ErrorHourCounter	Accumulated number of error hours	x	x				
t1	Current value of t1						
t2	Current value of t2						
t3	Current value of t3						
t4	Current value of t4						
t1-t2 (Δt)	Current differential value						
Flow (V1)	Current water flow of V1						
Flow (V2)	Current water flow of V2						
Power 1	Current heat power (E1)						
P1	Current value of analog input of P1						
P2	Current value of analog input of P2						

MULTICAL® 603

3.2.12 Encryption level >T<

MULTICAL® 603 must be ordered with encrypted data transmission between module and reading system. Data is encrypted with 128 bit AES counter mode encryption. Data transmission can be encrypted with either a common or an individual encryption key.

If you choose individual encryption key (T-code 3) the reading system must know the encryption key of the individual meter in order to read the meter. The encryption key is sent to the customer and then "matched" with the serial number of the individual meter in the reading system.

If you choose common encryption key (T-code 2), this key can be used for reading a customer-specific number of meters. The key is created by Kamstrup A/S. A customer can have several encryption keys, e.g. one for each meter type.

Note: The common encryption key is only offered to customers on request.

The encryption level is configured as part of the meter's configuration number via the T-code. Upon receipt of order the T-code is by default configured at 3 - individual encryption key (unless otherwise informed by the customer). The encryption level can be configured when submitting the order. The encryption level cannot be changed after delivery.

Encryption level	T-code
Encryption via common key (customer-specific)	2
Encryption with individual key	3

Encryption keys can be downloaded from Kamstrup's customer portal "My Kamstrup" at www.kamstrup.com. Encryption keys are automatically entered in USB Meter Reader and READy.

IMPORTANT: If the encryption key in the meter is changed after delivery of the meter, the encryption type is changed from individual to common key or vice versa, the T-code is not changed. The T-code shown in the meter's display always indicates with which encryption type the meter was ordered and not the meter's current encryption type.

3.2.13 Customer label >VVVV<

A 20x50 mm customer label can be printed on the meter's front. The customer label to be printed on the meter's front is determined by the configuration number VVVV-code. The customer label can show utility logo, a bar code or the like. By default the meter's serial number is written in the customer label field.

Please contact Kamstrup A/S for information about possible customer labels as well as the creation of a new customer label.

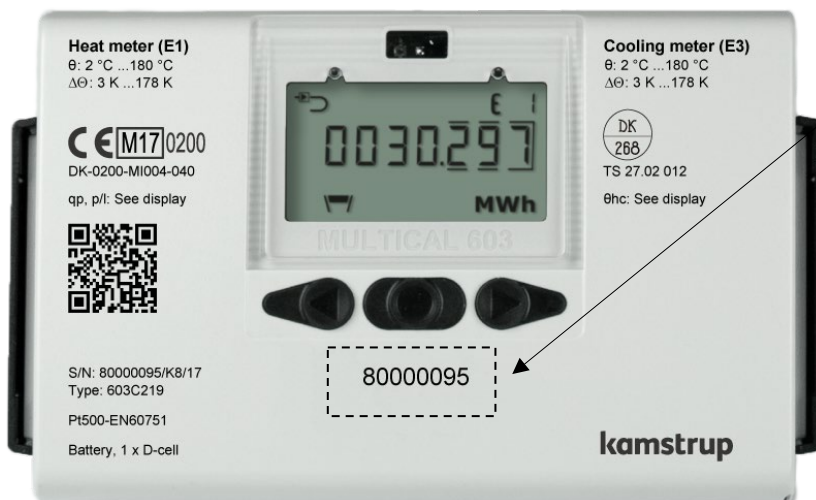

3.3 Data

The country code is selected as the last two characters of the meter's static part of the type number.

<i>Static data</i>	-	<i>Dynamic data</i>
603-xxxx	-	xxxxxxx
Written on the meter's front		Can be displayed

Type 603 - □ - □ - XX - □ - □□ - □ - □□ - □□

In addition to defining the language on the meter label as well as approval and verification marks, the country code is also used to control the configuration of a number of meter data.

During production of MULTICAL® 603 it is programmed with a number of measuring values in the fields listed overleaf. Unless the order includes specific requirements as to configuration, MULTICAL® 603 be supplied with the default values from the table.

	Automatic	To be stated in order	Standard
Serial no. (S/N) ¹ (See paragraph 3.4)	80.000.000	-	-
Customer no. Display No. 1 = 8 digits MSD Display No. 2 = 8 digits LSD	-	Up to 16 digits	Customer no. equal to S/N
Yearly target date 1 (MM.DD)	-	MM=1-12 and DD=1-31	Depends on country code
Monthly target date 1 (DD)	-	DD = 1-31	
Yearly target date 2 (MM.DD)	-	MM=1-12 and DD=1-31 + 00.00 (disabled) ²	
Monthly target date 2 (DD)	-	DD = 1-31 + 00 (disabled) ²	
Averaging period for min./max of power (P) and flow (Q) (See paragraph 7.5)	-	1...1440 min.	60 min.
Averaging period of CP (See paragraph 7.2)	-	5...30 days	7 days
θ_{hc} Heat/cooling shift Only active if meter type 6 is selected (See paragraph 7.4)	-	2...180,00 °C + 250,00 °C ³	Heat/cooling, meter type 6: 25,00 °C
Date/time	20YY.MM.DD/ hh.mm.ss	GMT ± 12,0 hours (Can be defined at half hour intervals)	-
GMT offset	-	-	Depends on country code
Primary address of M-Bus, Modbus and BACnet ⁴	-	Address 0-250 (depending on module)	Last 2-3 digits of customer number
M-Bus ID no. (used for secondary address)	-	-	Customer no.
wM-Bus ID no.	-	-	Serial number

MULTICAL® 603

	Automatic	To be stated in order	Standard
Offset of t1 and t2 ($\pm 0.99K$) ⁴ (See paragraph 7.3)	To be entered on the basis of R_0 of the sensor element as well as the cable resistance. If no sensor data is available, offset is set to 0,00 K.	-	-
t2 preset Only active if meter type 4 is selected.	-	0,01...185,00 °C + 250,00 °C	250,00 °C
t3 preset	-	0,01...185,00 °C + 250,00 °C	250,00 °C
t4 preset	-	0,01...185,00 °C + 250,00 °C	5,00 °C
t5 preset Only relevant for meter types 1 and 2. (See paragraph 7.1.3)	-	0,01...185,00 °C	50,00 °C
Scheduler profile (See paragraph 7.12)	-	Created scheduler profiles	Depends on the country code (Default deactivated)
DST (Daylight Saving Time) (See paragraph 7.11)	-	Enabled / Disabled	Depends on country code
Fluid type code ⁶	-	4-digit code for fluid type and concentration level	-

¹ Serial no. (factory set unique serial number) is written on the meter and cannot be changed after factory programming.

² Yearly target date 2 (MM.DD) and monthly target date 2 (DD) are set to 00.00 and 00, respectively. If these target dates are disabled, the meter just uses yearly target date 1 and monthly target date 1.

³ $\theta_{hc} = 250,00\text{ °C}$ disconnects the function. In all other meter types than 6, θ_{hc} is disabled and cannot be enabled after delivery.

⁴ Applying both to the internal M-Bus and the two module slots in the meter. At submission of order, you can choose "fixed M-Bus address" which means that all meters included in the order are configured with the same primary address.

⁵ R_0 is the resistance value of the sensor element in ohm (Ω) at 0 °C.

⁶ It is only possible to select the fluid type code on MULTICAL® 603-M for Mixed Fluid, see more in chapter 13.

3.3.1 Serial number and extended availability

The serial number consists of 8 digits (xxxxxxx/WW/yy) a 2-digit device code for extended availability (xxxxxxx/WW/yy) and the production year (xxxxxxx/WW/yy). The serial number (factory set unique serial number) is written on the meter and cannot be changed after factory programming.

You need the encryption key of the specific meter to be able to read the meter via wireless M-Bus. This encryption key is sent to the customer if the meter is purchased directly from Kamstrup A/S. Customers who buy their meters from wholesalers can download their encryption key from Kamstrup's "Encryption Key Service" where the customer can create a user profile without contacting Kamstrup A/S. Next, the customer enters the meter's serial number as well as the two digits (device code) for extended availability and downloads the encryption key. The two digits have been introduced in order to provide a secure method for customers who buy Kamstrup meters from a wholesaler to download the required encryption keys.

The screenshot displays the 'Encryption Key Service' interface. At the top, a search bar contains the text 'xxxxxxx/WW/23'. Below this, the 'DEVICES' section shows a search for '79823737' and a list of found devices. A table lists one device with the following details:

SERIAL NUMBER	ORDER	PRODUCT
KAM79823737	25138486	MULTICAL® 603

To the right, the 'REGISTER DEVICES' form is visible, with fields for 'Serial number' (E.g. KAM12345678) and 'Device code' (E.g. A0). The interface also includes a sidebar with navigation options like 'ORDERS', 'PRODUCTS', and 'CUSTOMERS', and a footer with pagination information: 'Page 4 of 1' and '100 rows'.

MULTICAL® 603

3.3.2 Target date

MULTICAL® 603 can be configured with up to two yearly target dates and two monthly target dates. These dates determine on which date data is to be logged (saved) in the meter’s interval logger. To avoid confusion about at which time of the day the meter saves data, MULTICAL® 603 also, in addition to the date, includes a time stamp for the logging. This time stamp is not included in this meter’s predecessor, MULTICAL® 602, which simply stamps data with a date. This difference also means that the date stamps of the two meters vary in spite of the fact that both meters are configured with a target date, e.g. 01.01 [MM.DD]. Note that although the date stamps of the two meters are different, both meters will in practice log (save) data at the same time. This is illustrated by the following example:

	<i>MULTICAL® 302/402/602</i>	<i>MULTICAL® 303/403/603/803</i>
Yearly target date [MM.DD]	01.01	01.01
Monthly target date [DD]	01	01
Date/time [20YY.MM.DD/ hh.mm.ss]	2018.12.31 / 24.00.XX ¹	2019.01.01 / 00.00.XX

¹Note that it is not possible to read out this time stamp from the meter.

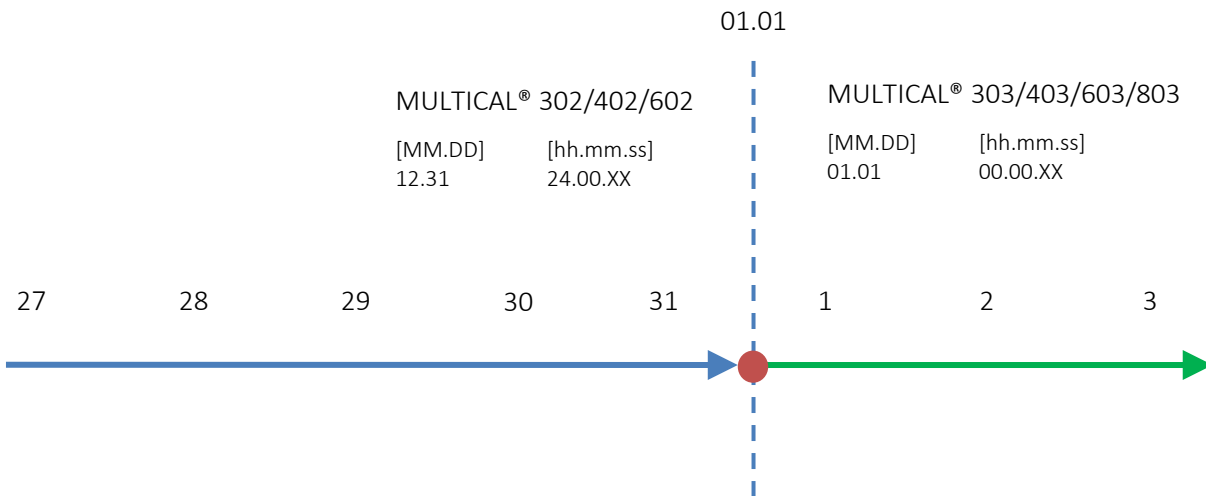

4 Installation

4.1 Installation requirements

Prior to installation of MULTICAL® 603 in connection with flow sensors, the heating system should be flushed while a fitting piece replaces the meter. When ULTRAFLOW® is mounted, the adhesive wafers are removed from the meter's inlet and outlet, and the flow sensor is mounted with couplings/flanges. New fibre gaskets in original quality must be used.

If other couplings than the original ones from Kamstrup A/S are used, you must make sure that the threaded lengths of the couplings do not prevent proper tightening of the sealing surface.

The positioning of the flow sensor in inlet or outlet can be configured in the calculator before commissioning, see paragraph 6.3 about "SETUP loop". The flow direction is indicated by an arrow on the flow sensor.

In order to avoid cavitation, the back pressure at ULTRAFLOW® (the pressure at the flow sensor outlet) must typically be minimum 1 bar at q_p and minimum 2 bar at q_s . This applies to temperatures up to approx. 80 °C.

When the installation has been completed, water flow can be turned on. The valve on the flow sensor's inlet side must be opened first.

ULTRAFLOW® must not be exposed to lower pressure than the ambient pressure (vacuum).

Permissible operating conditions

Ambient temperature: 5...55°C (indoors). Max 30 °C for optimum battery lifetime.

Medium temperature of heat meter: 2...130 °C with calculator mounted on a wall
15...90 °C with calculator mounted on ULTRAFLOW®

Medium temperature of cooling meter: 2...130 °C with calculator mounted on a wall

Medium temperature of heat/cooling meter: 2...130 °C with calculator mounted on a wall

System pressure ULTRAFLOW®: 1,0...16 bar for threaded meters
1,5...25 bar for flange meters

Electrical installations

MULTICAL® 603 is available with either 24 VAC/VDC or 230 VAC supply modules. The supply modules are connected to mains using two-wire cable without protective earth.

Use a strong connection cable with an outer diameter of max 5-8 mm and ensure correct cable stripping and cable relief in the meter. It must be ensured that the entire installation complies with current regulations, the supply cable to the meter must never be protected by a larger fuse than permitted. In case of doubt, it is recommended to take advice from an authorised electrician.

Service

Neither welding nor freezing is allowed while ULTRAFLOW® is mounted. Before starting such work, ULTRAFLOW® must be dismantled. If the meter is mains supplied, the supply must be switched off.

In order to facilitate the replacement of the meter, closing valves should always be mounted on both sides of the flow sensor.

Under normal operating conditions no pipe strainer is required in front of the meter.

4.2 Mounting of MULTICAL® 603 calculator

4.2.1 Compact mounting

Compact mounting means that the calculator is mounted directly on ULTRAFLOW®. If there is risk of condensation (e.g. in cooling applications), the calculator ought to be wall-mounted. Furthermore, in cooling applications ULTRAFLOW® must be the condensation-proof version.

The construction of MULTICAL® 603 can provide minimum installation depth, using an angle fitting when mounting ULTRAFLOW®. Due to the design the mounting radius remains 75 mm in critical places.

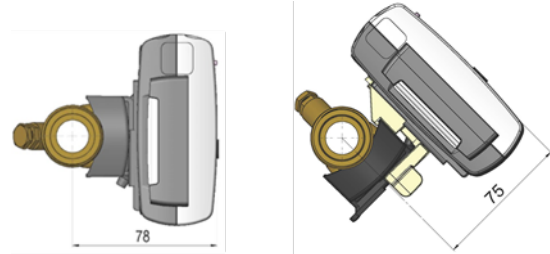



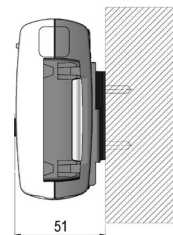

4.2.2 Wall mounting

The calculator can be mounted directly on an even wall. Wall mounting requires a wall fitting (3026-207), which is available as an accessory to MULTICAL® 603. MULTICAL® 603 is mounted on the wall fitting by sliding the calculator onto the fitting in the same way as it is done by compact mounting.



4.3 Mounting in inlet or outlet

MULTICAL® 603 is configured for flow sensor mounted in either forward or return pipe during installation. In the display, the flow sensor position is indicated by a symbol; subjacent the A-code of the configuration number is programmed to 3 or 4 for flow sensor position in inlet and outlet, respectively. The table below indicates installation conditions of heat meters and cooling meters:

Formula	k-factor	A-code and display	Hot pipe	Cold pipe	Installation
Heat meter $E1=V1(t1-t2)k$	k-factor for t1 and V1 in inlet	A-code = 3 Display 	V1 and t1	t2	See application no. 1 in paragraph 7.1
	k-factor for t2 and V1 in outlet	A-code = 4 Display 	t1	V1 and t2	See alternative position of flow sensor in application no. 1 in paragraph 7.1
Cooling meter $E3=V1(t2-t1)k$	k-factor for t1 and V1 in inlet	A-code = 3 Display 	t2	V1 and t1	See application no. 1 in paragraph 7.1
	k-factor for t2 and V1 in outlet	A-code = 4 Display 	V1 and t2	t1	See alternative position of flow sensor in application no. 1 in paragraph 7.1

4.4 EMC conditions

MULTICAL® 603 has been designed and CE-marked according to EN 1434 Class A and C (corresponding to electromagnetic environment: Class E1 and E2 of the Measuring Instruments Directive) and can thus be installed in both residential and industrial environments.

All control cables must be drawn separately and not parallel to e.g. power cables or other cables with the risk of inducing electromagnetic interference. There must be a distance of min. 25 cm between signal cables and other installations.

4.5 Climatic conditions

MULTICAL® 603 is designed for indoor installation with ambient temperatures from 5...55 °C, but max 30 °C in order to obtain optimal battery lifetime. Protection class IP 65 of the calculator allows splashes of water, but the meter must not be submerged.

4.6 Sealing

According to EN 1434, MULTICAL® 603 must have protection devices, which can be sealed to the effect that after sealing, both before and after the heat meter has been correctly installed, it is impossible to dismount, remove or change the heat meter or its adjustment devices without visibly damaging meter or sealing. Correct sealing of MULTICAL® 603 includes two levels, installation sealing and verification sealing, a breach of sealing has different consequences on each level.

Installation sealing

Having completed the installation of MULTICAL® 603 installation sealing is the last thing to be done. The installation seal is the 'outermost' sealing level to be completed by the installer/utility. The installation sealing must make sure that calculator top and base cannot be separated and that flow sensor and temperature sensors cannot be dismounted without visible signs that a separation has taken place. In practice the installation sealing can be done by means of wire and seal, sealing label or a combination. The sealing is the utility's security that unauthorized persons cannot undiscovered change the installation around the meter. A breach of the installation sealing alone does not influence the meter's possibility for renewed installation sealing or the fact that it is legal in relation to its approval and verification.

Installation sealing and "SETUP loop"

In order to bring MULTICAL® 603 back to "SETUP loop" after installation, the calculator top and base must be separated, after which the "SETUP loop" can be accessed either via the front keys or METERTOOL HCW. Separation of calculator top and base implies that the calculator's installation seal is broken.

Verification seal

The MULTICAL® 603 verification seals consist of both mechanical and electronic sealing. The verification seals marked "LOCK" and "TEST" are placed on the white verification cover in the calculator top. These seals can be seen as the 'innermost' sealing level, which may only be broken by authorized laboratories in connection with test and reverification of the meter. If the meter is to be used for legal operation in relation to approval and verification after breach of verification sealing, the broken seals must be resealed. The sealing must be carried out by an authorized laboratory using the sealing mark (void label) of the laboratory.

5 Dimensional sketches

All measurements in [mm]. The weight of a MULTICAL® 603 calculator is 450 g, including D-cell battery (HC-993-02), M-Bus module (HC-003-21) and linkIQ/wM-Bus module (HC-003-32).

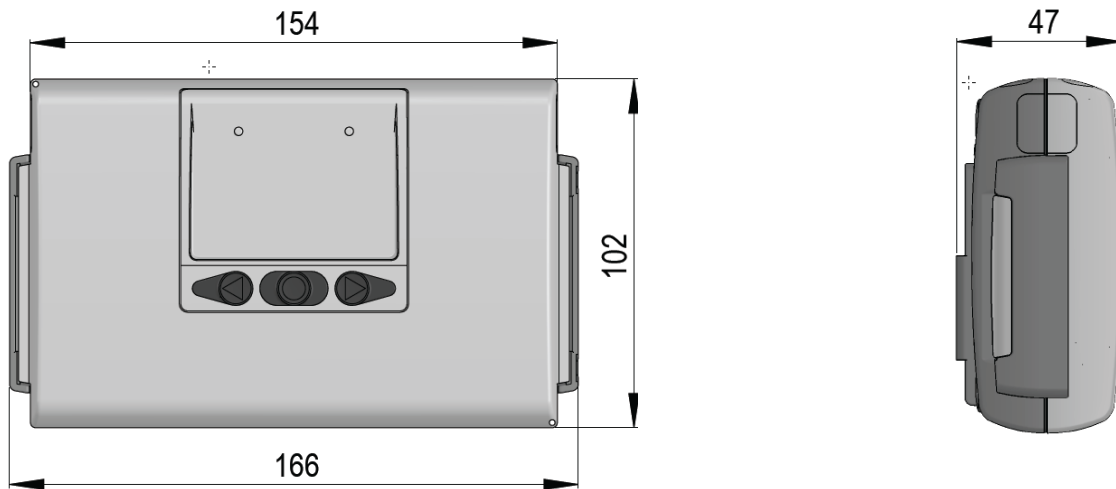

Figure 3: Mechanical measurements of MULTICAL® 603 calculator

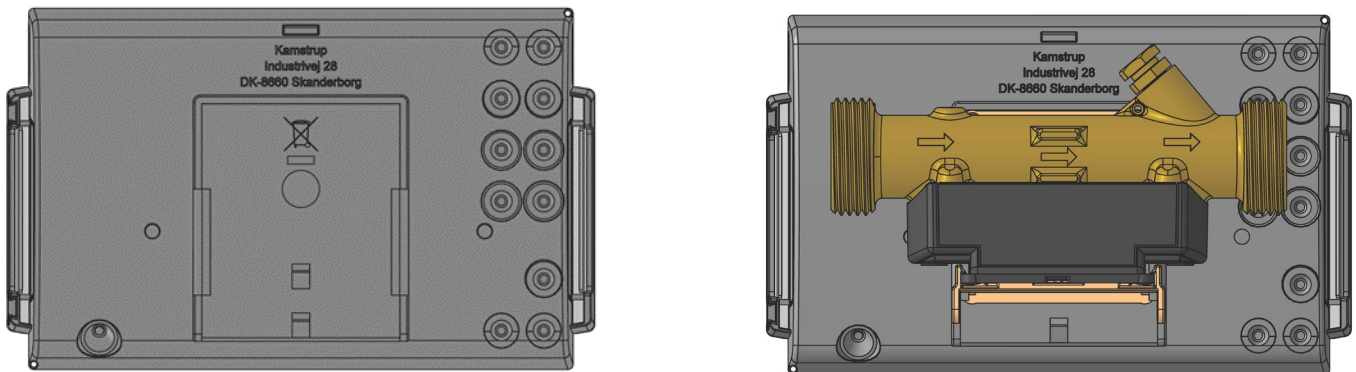

Figure 4: Calculator base separate and mounted on ULTRAFLOW®

MULTICAL® 603

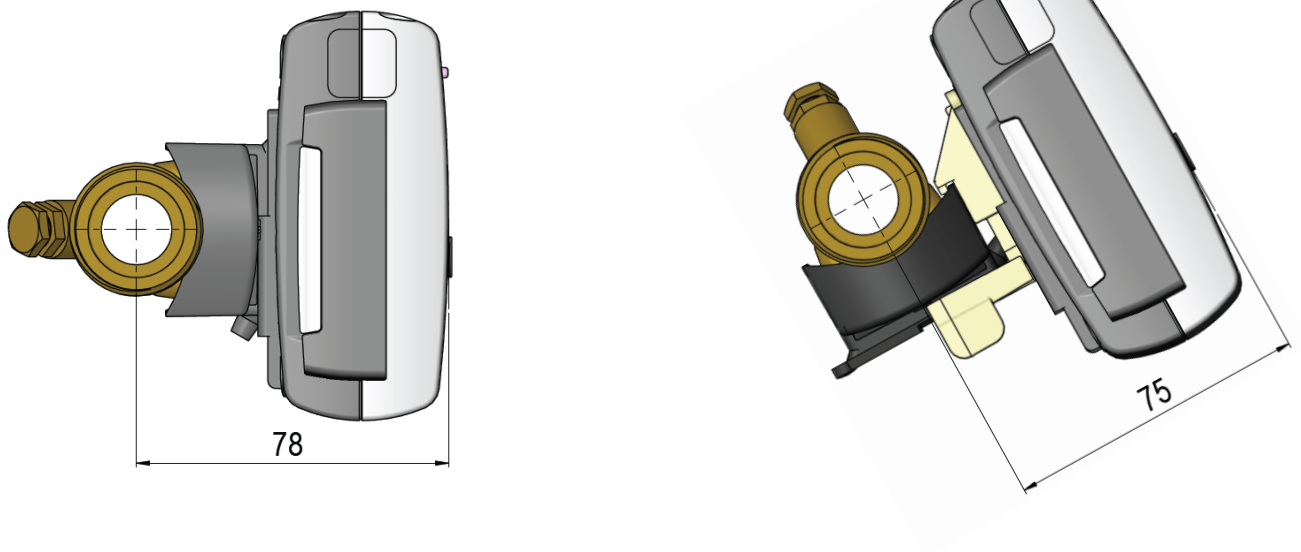

Figure 5: MULTICAL® 603 mounted on ULTRAFLOW® with G $\frac{3}{4}$ threaded connection

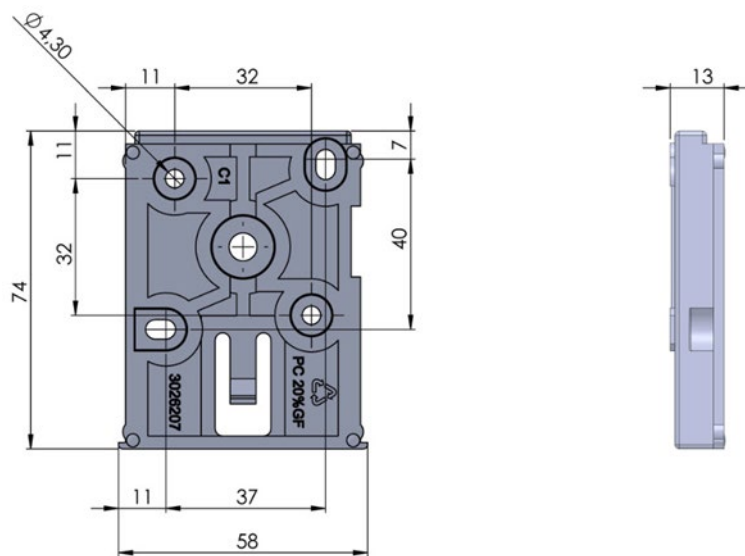
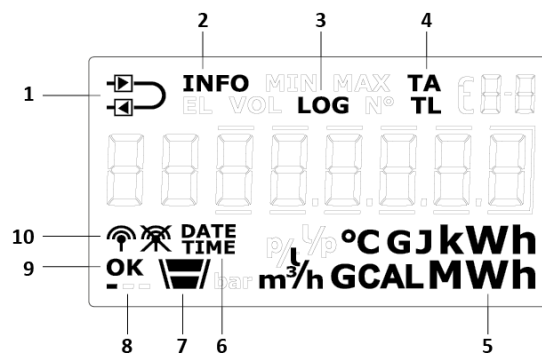

Figure 6: Wall bracket, 3026-207 for MULTICAL® 603

6 Display

MULTICAL® 603 has a bright and clear display including 7 or 8 digits, depending on configuration, and a number of symbols for measuring units, info, inlet and outlet, radio on/off, etc. The display changes reading or is turned on when pressing on of the keys, which are placed on the meter's front. Furthermore, MULTICAL® 603 can be configured with light in the display, which automatically turns off 15 seconds after the latest activation of a key.

Depending on the selected integration mode (L-code), the display either switches off 4 minutes after the latest activation of a key or remains switched on. At the same time, it is possible to choose an integration mode in which the display's background light remains lit. Thus the selected integration mode influences the meter's battery lifetime. Read more about the battery lifetime in paragraph 10.4 and the meter's integration modes in paragraph 3.2.7.



1	The meter is configured as inlet or outlet meter
2	Flashes at active info code
3	Active at historical readings
4	Tariff registers/tariff limits
5	Measuring unit

6	Date and time
7	Level indicator of menu loops
8	Heart beat indication shows that both meter and display are active
9	"OK" is displayed when a changed value has been saved
10	The meter's radio communication is switched on or off

The meter uses four different display loops. The four loops are intended for four different usage situations.

- "USER loop"**
 The meter's configurable display loop is intended for the user. The readings in this loop can be adjusted to the utility company's requirements via the DDD-code. See paragraph 3.2.4 for an overview of possible readings in the meter's "USER loop". The same paragraph includes examples of DDD-codes.
- "TECH loop"**
 This loop is intended for technicians and is not configurable. The "TECH loop" contains all display readings, with the exception of logged values and the differential registers, and this loop is *not* configurable. The loop comprises readings such as serial number, date, time, config no., software revision and segment test. See paragraph 6.2 for a complete overview of the readings.
- "SETUP loop"**
 "SETUP loop" is intended for the technician too. In this loop the technician can configure the meter via the front keys. In general (unless otherwise informed by the customer), the loop is open in transport state. When the meter for the first time registers a flow of 1 % of qp or larger, the access to the "SETUP loop" is blocked. From now on it is no longer possible to access "SETUP loop" unless you break the installation seal. See paragraph 6.3 for further details about the various parameters which can be configured in the "SETUP loop", and see paragraph 7.8 for details on the meter's transport state.
- "TEST loop"**
 Used by authorized laboratories for reverification of the meter. This loop is not available unless the meter's test seal (verification seal) is broken.

MULTICAL® 603

By means of the meter's front keys, you can choose from and switch between the four display loops. When delivered, the meter is in transport state, which means that the "USER loop", "TECH loop" and "SETUP loop" are available. Depending on the country code, the access to the "SETUP loop" may be blocked in transport state, and the "SETUP loop" is thus not available on delivery. The "TEST loop" can only be accessed if the test seal (verification seal) is broken.

By keeping the primary key activated for 5 seconds, you navigate to LOOP select. Here, you can use the arrow keys to switch between the meter's display loops. In the "TECH loop", "SETUP loop" and "TEST loop", index numbers are used as the readings in these display loops are allocated to a specific index number. The index numbers facilitate navigation to the required reading. Index numbers are not used in the configurable "USER loop". The below figure illustrates how it is possible to navigate in the meter's display by means of the front keys.

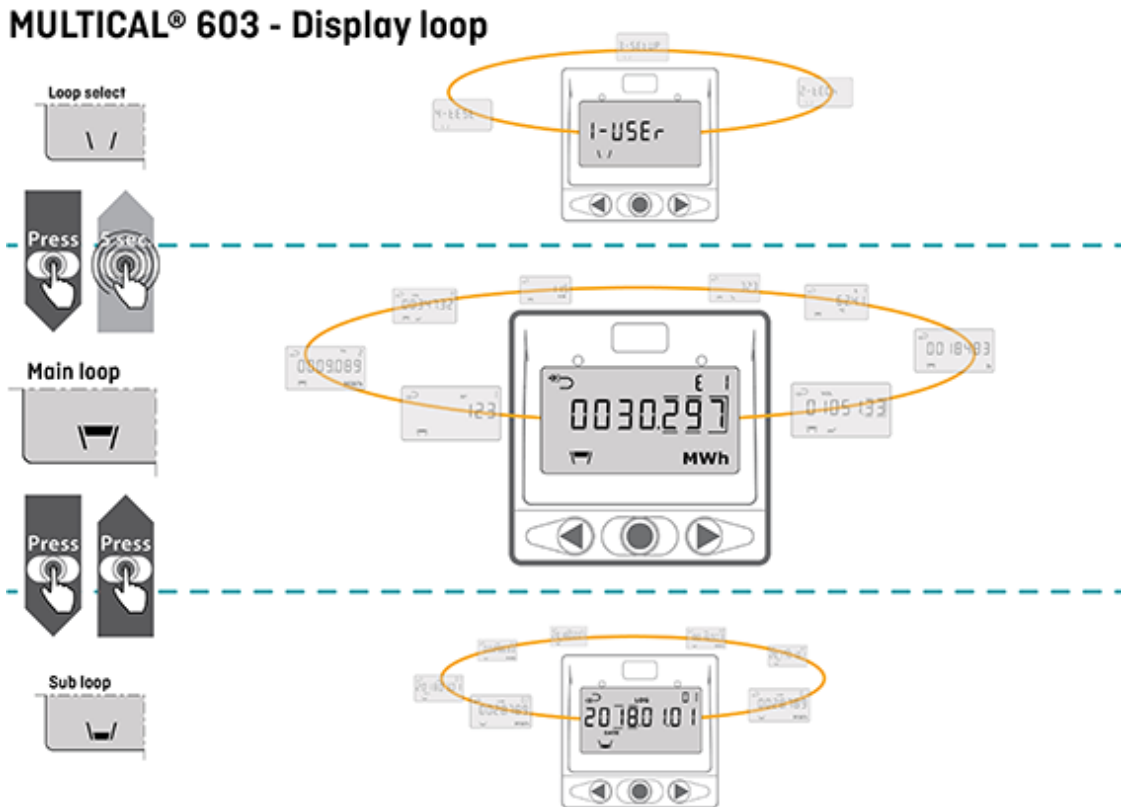

Readings in case of error

In order to facilitate the diagnostics work, lines are shown in the display readings (current values) which are influenced by the error, and at the same time, counting stops in the registers, which are depending on the given parameter and thus influenced by the error. In case of interrupted or short-circuited temperature sensor the corresponding display reading will include lines. MULTICAL® 603 registers these errors and sets an info code, which can easily be read from the display. Read more about info codes in paragraph 7.7.

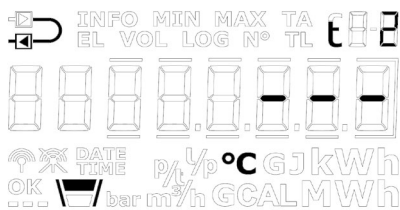

Reading of t2 in case of temperature sensor error

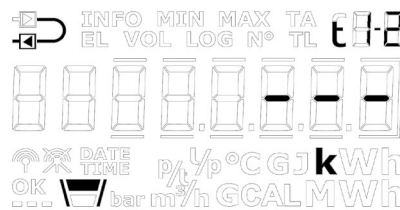

Reading of temperature difference t1-t2 at temperature sensor error

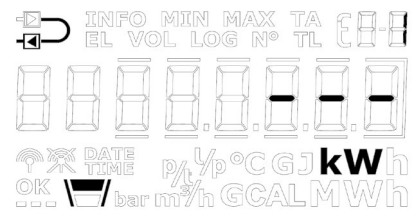

Error in power reading as a result of temperature sensor error

	t1 error	t2 error	t3 error	V1 Flow error	V2 Flow error
t1 inlet	Display - - -				
t2 outlet		Display - - -			
Δt (t1-t2)	Display - - -	Display - - -			
t3			Display - - -		
Flow, V1					
Power, V1	Display - - -	Display - - -			
E1	No counting	No counting			
E2	No counting	No counting			
E3	No counting	No counting			
E4	No counting		No counting		
E5		No counting	No counting		
E6			No counting		
E7	No counting		No counting		
E8	No counting				
E9		No counting			
E10			No counting		
E11			No counting		
V1					
V2					
A1	No counting	No counting			
A2	No counting	No counting			

Display reading in case of cut-off of flow

After a system cut-off, the actual flow reading in MULTICAL® 603 will drop to 0 l/h during only a few seconds when a flow sensor with fast pulses such as ULTRAFLOW® is used.

When MULTICAL® 603 is connected to flow sensors with slow pulses, e.g. a reed switch, it will first indicate a decreasing actual flow several minutes after the cut-off. MULTICAL® 603 automatically sets the flow reading to 0 l/h after 60 minutes without pulses.

For flow sensors with slow pulses, the flow reading will in general react slower and be less suitable for indicating low flows than when using flow sensors with fast pulses.

MULTICAL® 603

Heart beat and status indication

MULTICAL® 603 uses the three small display segments in the lower left corner of the display to indicate various status scenarios. Each segment will, depending on whether it is static or flashes, provide information about the given functionality in the meter. This is shown in the figure below:

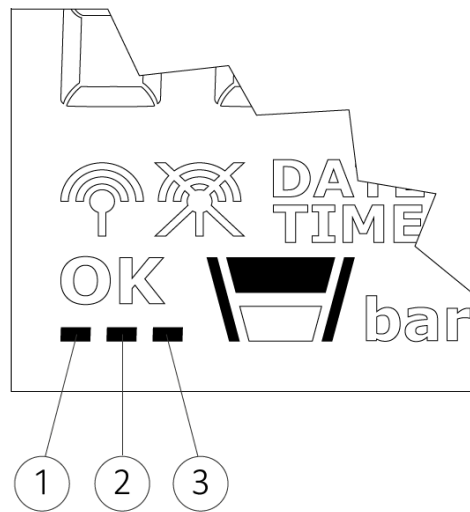

① Heart beat segment

Flashes - This segment always flashes as an indication that both the meter and display are active.

② SETUP and config segment

Constantly lit - The meter's config log is full, and it is therefore no longer possible to change the configuration.

Flashes - It is possible to access the "SETUP loop". The segment flashes as long as the meter is in transport state or 4 minutes after the calculator top and base have been separated.

Turned off - It is not possible to access the "SETUP loop" or to configure the meter via METERTOOL HCW.

③ Optical interface segment¹

Constantly lit - The meter's optical interface is deactivated, and optical communication is thus not possible.

Flashes - The optical interface is temporarily active, flashes for 4 minutes after the calculator top and base have been separated. In this period of time, it is possible to activate the optical interface permanently.

Turned off - The optical interface is active, and it is possible to communicate with the meter.

¹ The optical interface can be deactivated and activated via the optical readout head and METERTOOL HCW. See Technical Description for METERTOOL HCW (5512-2097).

Positive/negative signs in heat/cooling applications

The accumulated energy registers, E1 and E3, are both always displayed as positive values. Differential temperature and power are either displayed as positive (heat) or negative (cooling) when reading the values on MULTICAL® 302, 303, 403, 603 and 803.

6.1 "USER loop"

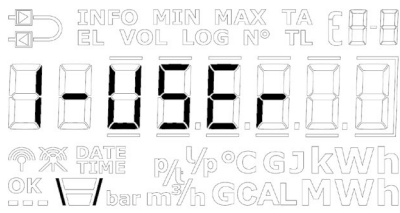

The "USER loop" is the meter's primary loop, which includes the legal and most used readings. The loop is intended for the user and is configured according to the user's requirements via the DDD-code. See paragraph 3.2.4 for further information on the "USER loop" and DDD-codes.

Note: No display index numbers are used in the "USER loop".

6.2 "TECH loop"

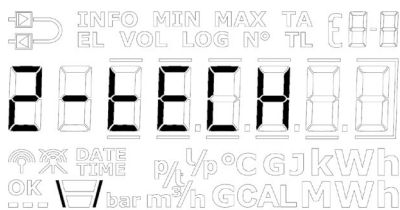





The "TECH loop" is intended for the technician, who is interested in viewing more readings than the ones available in the "USER loop".



The "TECH loop" contains all display readings, with the exception of logged values and the differential registers, and this loop is not configurable. The module readings consist of a number of fixed readings and readings that depend on the mounted module.

The meter's "TECH loop" is shown below. You can switch forwards and backwards between the readings using the arrow keys, while a brief activation of the primary key switches between primary and secondary readings.



"TECH loop"				Display	
Primary reading 		Secondary reading 		Index number in display	Logging depth /reference number
1	Heat energy E1			2-001-00	
		1.1	Date of yearly logger	2-001-01	Log 01-02
		1.2	Data of yearly logger ¹	2-001-02	
		1.3	Date of monthly logger	2-001-03	Log 01-12
		1.4	Data of monthly logger ¹	2-001-04	
		1.5	E1 High-resolution		
2	Cooling energy E3			2-002-00	
		2.1	Date of yearly logger	2-002-01	Log 01-02
		2.2	Data of yearly logger ¹	2-002-02	
		2.3	Date of monthly logger	2-002-03	Log 01-12
		2.4	Data of monthly logger ¹	2-002-04	
		2.5	E3 High-resolution		

Primary reading 		Secondary reading 		Index number in display	Logging depth /reference number
3	Energy E2			2-003-00	
		3.1	Energy E4	2-003-01	
		3.2	Energy E5	2-003-02	
		3.3	Energy E6	2-003-03	
		3.4	Energy E7	2-003-04	
4	Volume V1			2-004-00	
		4.1	Mass V1	2-004-01	
		4.2	Pressure 1	2-004-02	
		4.3	Date of yearly logger	2-004-03	Log 01-02
		4.4	Data of yearly logger ¹	2-004-04	
		4.5	Date of monthly logger	2-004-05	Log 01-12
		4.6	Data of monthly logger ¹	2-004-06	
		4.7	V1 High-resolution		
5	Volume V2			2-005-00	
		5.1	Mass V2	2-005-01	
		5.2	Pressure 2	2-005-02	
		5.3	Date of yearly logger	2-005-03	Log 01-02
		5.4	Data of yearly logger ¹	2-005-04	
		5.5	Date of monthly logger	2-005-05	Log 01-12
		5.6	Data of monthly logger ¹	2-005-06	
6	Hour counter			2-006-00	
		6.1	Error hour counter	2-006-01	N° 60
7	t1 (Inlet)			2-007-00	
		7.1	Year-to-date average ²	2-007-01	
		7.2	Month-to-date average ²	2-007-02	
8	t2 (Outlet)			2-008-00	
		8.1	Year-to-date average ²	2-008-01	
		8.2	Month-to-date average ²	2-008-02	
9	Δt (t1-t2) cooling is indicated by -			2-009-00	
		9.1	E8 (V1·t1)	2-009-01	
		9.2	E9 (V1·t2)	2-009-02	
10	t3			2-010-00	
		10.1	E10 (V1·t3)	2-010-01	
		10.2	E11 (V2·t3)	2-010-02	

Primary reading 		Secondary reading 		Index number in display	Logging depth /reference number
11	t4 (programmed)			2-011-00	
12	Flow V1			2-012-00	
		12.1	Date of max this year ³	2-012-01	
		12.2	Data of max this year ¹	2-012-02	
		12.3	Date of max this month ³	2-012-03	
		12.4	Data of max this month ¹	2-012-04	
		12.5	Date of min. this year ³	2-012-05	
		12.6	Data of min. this year ¹	2-012-06	
		12.7	Date of min. this month ³	2-012-07	
		12.8	Data of min. this month ¹	2-012-08	
13	Flow V2			2-013-00	
14	Thermal output, V1, cooling is indicated by -			2-014-00	
		14.1	Date of max this year ³	2-014-01	
		14.2	Data of max this year ¹	2-014-02	
		14.3	Date of max this month ³	2-014-03	
		14.4	Data of max this month ¹	2-014-04	
		14.5	Date of min. this year ³	2-014-05	
		14.6	Data of min. this year ¹	2-014-06	
		14.7	Date of min. this month ³	2-014-07	
		14.8	Data of min. this month ¹	2-014-08	
15	Input A1 ⁴			2-015-00	
		15.1	Meter no. of input A1	2-015-01	
		15.2	L/imp. of input A1	2-015-02	N° 65
		15.3	Date of yearly logger	2-015-03	Log 01-02
		15.4	Data of yearly logger ¹	2-015-04	
		15.5	Date of monthly logger	2-015-05	Log 01-12
		15.6	Data of monthly logger ¹	2-015-06	
16	Input B1 ⁴			2-016-00	
		16.1	Meter no. of input B1	2-016-01	
		16.2	L/imp. of input B1	2-016-02	N° 67
		16.3	Date of yearly logger	2-016-03	Log 01-02
		16.4	Data of yearly logger ¹	2-016-04	
		16.5	Date of monthly logger	2-016-05	Log 01-12
		16.6	Data of monthly logger ¹	2-016-06	

Primary reading 		Secondary reading 		Index number in display	Logging depth /reference number
17	Input A2⁴			2-017-00	
		17.1	Meter no. of input A2	2-017-01	
		17.2	L/imp. of input A2	2-017-02	N° 65
		17.3	Date of yearly logger	2-017-03	Log 01-02
		17.4	Data of yearly logger ¹	2-017-04	
		17.5	Date of monthly logger	2-017-05	Log 01-12
		17.6	Data of monthly logger ¹	2-017-06	
18	Input B2⁴			2-018-00	
		18.1	Meter no. of input B2	2-018-01	
		18.2	L/imp. of input B2	2-018-02	N° 67
		18.3	Date of yearly logger	2-018-03	Log 01-02
		18.4	Data of yearly logger ¹	2-018-04	
		18.5	Date of monthly logger	2-018-05	Log 01-12
		18.6	Data of monthly logger ¹	2-018-06	
19	TA2			2-019-00	
		19.1	TL2	2-019-01	
20	TA3			2-020-00	
		20.1	TL3	2-020-01	
21	TA4			2-021-00	
			TL4	2-021-01	
22	A1 (A-) Heat discount			2-022-00	
		22.1	A2 (A+) Heat surcharge	2-022-01	
		22.2	t5	2-022-02	
23	CP			2-023-00	
			Actual power of input B1 ⁵	2-023-01	
			Averaging period of CP	2-023-02	
			Date of yearly logger	2-023-03	Log 01-02
			Data of yearly logger ¹	2-023-04	
			Date of monthly logger	2-023-05	Log 01-12
			Data of monthly logger ¹	2-023-06	
24	Info code			2-024-00	
		24.1	Info-event counter	2-024-01	
		24.2	Date for info logger	2-024-02	Log 01-50
		24.3	Data for info logger	2-024-03	

Primary reading 		Secondary reading 		Index number in display	Logging depth /reference number
25	Customer number (First part)			2-025-00	N° 1
		25.1	Customer number (Last part)	2-025-01	N° 2
		25.2	Date	2-025-02	
		25.3	Time	2-025-03	
		25.4	Yearly target date 1	2-025-04	
		25.5	Monthly target date 1	2-025-05	
		25.6	Yearly target date 2	2-025-06	
		25.7	Monthly target date 2	2-025-07	
		25.8	Serial number	2-025-08	N° 3
		25.9	Type number (dynamic) ⁹	2-025-09	N° 21
		25.10	Config 1 (ABCCDDDD)	2-025-10	N° 5
		25.11	Config 2 (EEFFGGLM)	2-025-11	N° 6
		25.12	Config 3 (NPPRRT)	2-025-12	N° 7
		25.13	Config 4 (VVVV)	2-025-13	N° 8
		25.14	Software revision	2-025-14	N° 10
		25.15	Software checksum	2-025-15	N° 11
		25.16	MID-004 certificate revision	2-025-16	N° 12
		25.17	BEK-1178 certificate revision	2-025-17	N° 13
		25.18	National certificate revision	2-025-18	N° 14
		25.19	Averaging time of min./max P and Q	2-025-19	
		25.20	θ_{hc}	2-025-20	
		25.21	T offset	2-025-21	
		25.22	Pulse figure (Imp./I or I/imp.)	2-025-22	
		25.23	Nominal flow rate (qp)	2-025-23	
		25.24	Internal M-Bus primary address	2-025-24	N° 34
		25.25	Temperature cutoff ($\Delta\theta$)	2-025-25 ¹⁰	
		25.26	Segment test	2-025-26 ¹¹	
101	Info Module 1 Config no. ⁶			2-101-00	N° 31
		101.x	Firmware revision ⁷	2-101-xx	N° 32
		101.x	Module serial number ⁷	2-101-xx	N° 33
		101.x	Primary address ⁷	2-101-xx	N° 34 ⁸
		101.x	M-Bus secondary addressing ⁷	2-101-xx	N° 35 ⁸
		101.x	M-Bus enhanced secondary address. ⁷	2-101-xx	N° 36 ⁸
		101.x	KM-RF frequency ⁷	2-101-xx	N° 37
		101.x	KM-RF network address ⁷	2-101-xx	N° 38

Primary reading 		Secondary reading 		Index number in display	Logging depth /reference number
201	Info Module 2 Config no. ⁶			2-201-00	N° 31
		201.x	Firmware revision ⁷	2-201-xx	N° 32
		201.x	Module serial number ⁷	2-201-xx	N° 33
		201.x	Primary address ⁷	2-201-xx	N° 34 ⁸
		201.x	M-Bus secondary addressing ⁷	2-201-xx	N° 35 ⁸
		201.x	M-Bus enhanced secondary addressing ⁷	2-201-xx	N° 36 ⁸
		201.x	KM-RF frequency ⁷	2-201-xx	N° 37
		201.x	KM-RF network address ⁷	2-201-xx	N° 38

¹ Depending on the selected depth of yearly and monthly logs in the programmable data logger, these display readings can be empty.

² The temperature average is volume-based.

³ Only the date of min./max is displayed in the format 20xx.xx.xx. By serial reading, the time (hh.mm) is included too.

⁴ Inputs A1, B1, A2 and B2 are updated continuously in the display of MULTICAL® 603, i.e. the display of the connected water or electricity meter will be in accordance with the display of MULTICAL® 603 without delay.

⁵ The unit of this reading is fixed at kW. The reading updates at the same speed as the integration interval, which is determined by the L-code.

⁶ These are fixed readings under module info.

⁷ These readings depend on the module and are thus not fixed readings. Depending on the module, the order of the readings can vary. Therefore, the index number is set to "xx".

⁸ For module 60 - LON FT-X3, the reference numbers 34, 35 and 36 will be used for displaying the module's Neuron ID divided into three parts. The module's Neuron ID is displayed in decimal format on the display. The read values must be converted from decimal to hexadecimal for use in the LON-system.

⁹ The module number in the dynamic type number is automatically updated when the module is replaced.







¹⁰ Temperature cutoff has been introduced from software revision 13351601 (P1), this display will not be available in earlier versions.

¹¹ In software revisions prior to 13351601 (P1) the segment test is found on index number 2-025-25.

6.2.1 Module readings

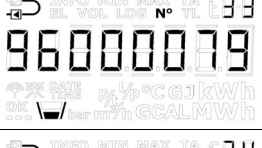
The "TECH loop" includes a number of module readings which depend on the mounted module. These readings are described in the respective technical descriptions for the modules. Simple modules, however, only include the primary reading "Type/Config no." (index number 2-101-00). If the meter is not fitted with a module, "Type/Config no." is displayed as "00000000".

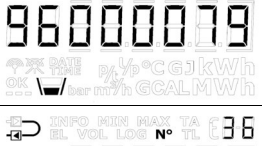
Note: Module readings can be empty due to delay or interrupted communication between meter and module. The heart beat indication shows that both meter and display are active.

	Index number in display	Display reading	Display reference number
Type/Config no.	2-101-00 / 2-201-00		N° 31
Firmware no./rev. Firmware 1357 C1	2-101-xx / 2-201-xx ¹		N° 32
Module serial number No. 12345678	2-101-xx / 2-201-xx ¹		N° 33
Primary address	2-101-xx / 2-201-xx ¹		N° 34 ⁸
M-Bus secondary ID	2-101-xx / 2-201-xx ¹		N° 35 ⁸
M-Bus enhanced secondary ID	2-101-xx / 2-201-xx ¹		N° 36 ⁸

¹ These readings depend on the module and are thus not fixed readings. The order of the readings can vary. Therefore, the index number is set to "xx". The reference number will, however, stay the same.

⁸ For module 60 - LON FT-X3, the reference numbers 34, 35 and 36 will be used for displaying the module's Neuron ID divided into three parts. The module's Neuron ID is displayed in decimal format on the display. The read values must be converted from decimal to hexadecimal for use in the LON-system.

6.3 "SETUP loop"

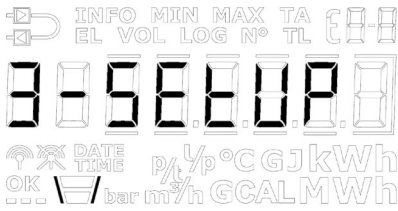

In this loop, it is possible to configure the meter via the front keys. This enables the technician to configure the meter both before installation and when the meter has been put into operation. Configuration of the meter after commissioning requires that the installation seal is broken and that the meter top is separated from the meter base.

Please note that it is only possible to configure the meter 50 times via the SETUP loop.
After 50 times, the meter is locked against further configuration, and total reset and reverification of the meter are required to regain access to the SETUP loop.

How to open the "SETUP loop"

1. In general (unless otherwise informed by the customer), the "SETUP loop" is available when the meter is in transport state. The meter leaves the transport state when the meter for the first time registers a flow of 1 % of qp or larger, or if the "SETUP loop" is ended via the menu item "EndSetup". A total reset of the meter is the only way to return to transport state.
2. When the meter is in operation, i.e. the meter has left transport state, the "SETUP loop" can be accessed by breaking the meter's installation seal and separating and reassembling the calculator top and the calculator base.

How to exit the "SETUP loop"

You can exit the "SETUP loop" in three ways. All three ways can be used both in transport state and after the meter has been put into operation.







1. Keep the primary key activated and navigate to the meter's other loops.
2. After 4 minutes, the meter will reach time-out and return to the first reading in the "USER loop".
3. Navigate to the menu item "EndSetup" in the "SETUP loop", and keep the primary key activated for 5 seconds, while the frames around the reading increments, and the display in the end shows "OK".

Note: This locks the access to the "SETUP loop", and thereby the meter is locked against further configuration. Subsequent reconfiguration of the meter requires that you break the installation seal.

IMPORTANT: "EndSetup" is an important function when the meter is in transport state, but when the meter is in operation, "EndSetup" is just one of three ways to exit the SETUP loop.

As it appears from the table above, the purpose of the menu item "EndSetup" is to enable the technician to lock the access to the "SETUP loop" in transport state and thus lock the meter against further configuration. This function is e.g. relevant to a technician who knows that a meter is to be mounted in the installation for some time before the first integration is carried out and wants to lock the access to the "SETUP loop" immediately after the installation to ensure that no further configuration is possible.

It also appears from the table below that no matter how the "SETUP loop" is closed when the meter is in operation, the installation seal must be broken again and the calculator top and base must be separated if the technician wants to regain access to the "SETUP loop".

	Transport state	In operation
4. Primary key	 Access to the "SETUP loop"	 Access to the "SETUP loop" blocked
5. Timeout	 Access to the "SETUP loop"	 Access to the "SETUP loop" blocked
6. EndSetup	 Access to the "SETUP loop" blocked	 Access to the "SETUP loop" blocked

6.3.1 Change of parameters in the "SETUP loop"

You can navigate to the "SETUP loop" from the "USER loop" by activating the primary key for 5 seconds and then use the arrow keys to navigate to 3- SETUP that is accessed by pressing the primary key once. The "SETUP loop" does not include secondary readings, and therefore, the index number always consists of 4 digits, see table with SETUP parameters on the next page. The arrow keys are used for switching between the readings. In the "SETUP loop", the primary key is used for accessing individual readings with the purpose of changing the parameter in question.

Pressing the primary key, the first digit of the parameter in question (the leftmost digit) starts flashing. The flashing digit can now be changed through brief activations of the primary key. Switch between the digits by pressing the arrow keys, move either to the right or to the left. When you have entered the required setup, activate the primary key until "OK" appears in the display. The meter has now saved the change and the display shows the set values.



Depending on the meter's configuration, one or more menu items in the "SETUP loop" will be displayed as "Off". This means that the function is not available in the meter, i.e. the function has been disabled during factory programming. If you try to access these readings via the primary key, the frames around "Off" becomes illuminated to indicate that this function is not available in the meter.

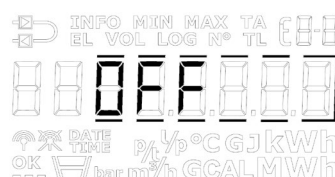
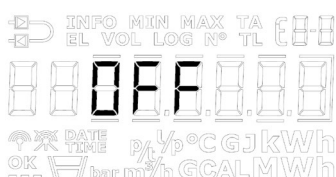

MULTICAL® 603

The table below shows the parameters that can be changed via the "SETUP loop". Below the table, each parameter is explained.

"SETUP loop"		Index number in display
1	Customer number (N° 1)	3-001
2	Customer number (N° 2)	3-002
3	Date	3-003
4	Time ¹	3-004
5	Yearly target date 1 (MM.DD)	3-005
6	Monthly target date 1 (DD)	3-006
7	Flow sensor position: Inlet or outlet flow (A-code)	3-007
8	Energy unit (B-code) (Can be set to kWh, MWh, GJ and Gcal)	3-008
9	Primary address of internal M-Bus (N° 34)	3-009
10	Primary address of module slot 1 (N° 34)	3-010
11	Primary address of module slot 2 (N° 34)	3-011
12	Averaging period of min./max P and Q	3-012
13	Heat/cooling shift (θ_{hc}) ² (Only available in meter type 6)	3-013
14	Temperature sensor offset (t_{r0}) ³	3-014
15	Radio on/off	3-015
16	Input A1 (preset register)	3-016
17	Input B1 (preset register)	3-017
18	Meter number of Input A1	3-018
19	Meter number of Input B1	3-019
20	TL2	3-020
21	TL3	3-021
22	TL4	3-022
23	Presetting t5	3-023
24	EndSetup	3-024

¹ In addition to adjusting the time via the "SETUP loop", time and date can also be changed via METERTOOL HCW and the modules.

² θ_{hc} can only be changed in meters configured as meter type 6. In this meter type, you can both change θ_{hc} and disable the function. If you attempt to access this menu in meters configured as other meter types, the message "Off" is displayed.

³ This function can have been disabled via the selected country code.

1. and 2. Customer no.

The customer number is a 16-digit figure distributed on two 8-digit menu items. The complete customer number can be adjusted via the two menu items in the "SETUP loop".

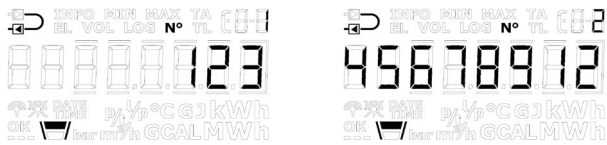

3. Date

The meter's date can be adjusted in the "SETUP loop". It is recommended to verify that the date was adjusted correctly, especially if time was adjusted too.

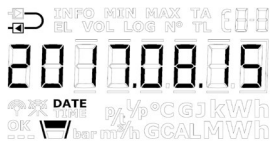

4. Time

The meter's time can be adjusted in the "SETUP loop". It is recommended to verify that the time was adjusted correctly, especially if the date was adjusted too.



5. Yearly target date 1

The meter's yearly target date 1 can be adjusted in the "SETUP loop". In MULTICAL® 603, it is possible to activate yearly target date 2. This function is switched off by default, i.e. set at 00.00. If yearly target date 2 is active in a meter we recommend that both yearly target dates are adjusted via METERTOOL HCW to ensure that they are correctly set with respect to each other. Note that the activation of yearly target date 2 influences the depth of the yearly log as the meter now makes two yearly loggings.

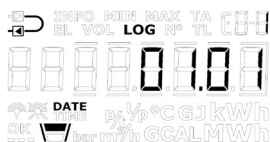

6. Monthly target date 1

The meter's yearly target date 1 can be adjusted in the "SETUP loop". In MULTICAL® 603, it is possible to activate monthly target date 2. This function is switched off by default, i.e. set at 00. If monthly target date 2 is active in a meter we recommend that both monthly target dates are adjusted via METERTOOL HCW to ensure that they are correctly set with respect to each other. Note that the activation of monthly target date 2 influences the depth of the monthly log as the meter now makes two monthly loggings.

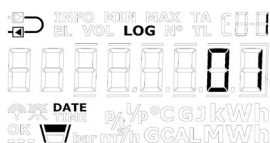

MULTICAL® 603

7. Flow sensor position: Inlet or outlet (A code)

The installation position of the flow sensor can be adjusted in the "SETUP loop". This means that the meter can be changed from being an outlet meter to being an inlet meter and vice versa. A symbol in the top left corner of the meter's display shows whether the meter is configured as an inlet or an outlet meter.

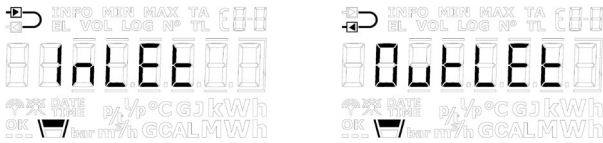

8. Energy unit (B-code)

The meter's measuring unit (B-code) can be adjusted in the "SETUP loop". It is thus possible to select if the meter's energy readings are to be shown in kWh, MWh, GJ or Gcal.

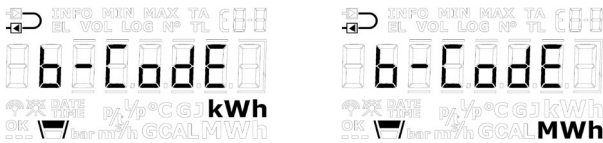

Note: The resolution of the energy unit always follows the one stated for the CCC-code with which a given MULTICAL® 603 is configured, see the CCC-tables in paragraph 3.2.3. Note that MULTICAL® 603 automatically switches to MWh if kWh is selected for MULTICAL® 603 with a CCC-code where kWh is not possible.

9. Primary address of internal M-Bus

It is possible to set the primary address of the internal M-Bus in MULTICAL® 603 in the "SETUP loop". The address can be selected in the interval 0...250.

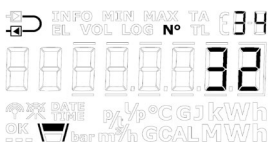

10. Primary address of module slot 1

It is possible to set the primary address of module slot 1 in MULTICAL® 603 in the "SETUP loop". The address can be selected in the interval 0...250.

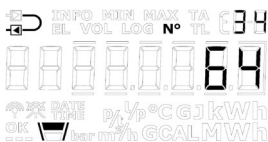

11. Primary address of module slot 2

It is possible to set the primary address of module slot 2 in MULTICAL® 603 in the "SETUP loop". The address can be selected in the interval 0...250.

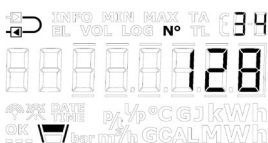

12. Averaging period of min/max P and Q

The averaging period used in the calculation of minimum and maximum values of power (P) and flow (Q) can be adjusted. The averaging period is indicated in the interval of 1...1440 minutes. Read more about the averaging period of min./max of P and Q in paragraph 7.5.

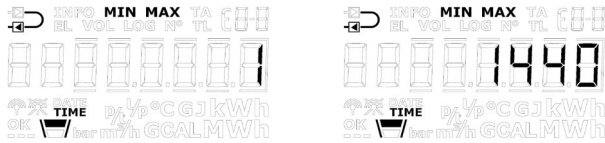

13. Heat/cooling shift (θ_{hc})

The limit for heat/cooling shift (θ_{hc}) can be adjusted in the "SETUP loop", however only in meters ordered as meter type 6 (heat/cooling meter). The value can be selected in the interval 2...180.00 °C as well as at 250.00 °C if the user wants to disable the function. The function is enabled again by setting the limit at a value in the valid area of 2...180 °C. Heat/cooling shift is permanently disabled on other meter types, and the display thus shows "Off" on all other meter types than 6. Read more about heat/cooling shift in paragraph 7.4.

Meter type: 1, 2, 3, 4, 5, 7	Meter type: 6
<p>The frames around "Off" illuminates as long as the primary key remains activated.</p>	<p>The first digit flashes and each digit can now be set at a value within the range 0...9.</p> <p>If you choose a value outside the valid interval (2...180,00 °C), the value is automatically adjusted to 250,00 °C, which indicates that the function has been switched off.</p>

MULTICAL® 603

14. Temperature sensor offset (t_{ro})

Temperature sensor offset (t_{ro}) can be adjusted in the "SETUP loop". Depending on the meter's configuration, this function can be disabled and the menu item will in that case display "Off".

Offset can be adjusted in the interval -0,99...0,99 K. By pressing the primary key, the 0 and the sign start flashing, and it is now possible to toggle between – and +, indicated in the display by the fact that the minus sign flashes and switches off respectively. By pressing the arrow keys, the meter shifts focus to the first decimal, i.e. it is not possible to change the value of the first digit as the valid interval is -0,99...0,99 K. Both the first and second decimal can be set to a value between 0 and 9. Read more about order data in paragraph 7.3.

Be aware of setting the required offset adjustment, not the error of the temperature sensor pair.
If the selected temperature sensor pair contributes with an error of -0,20 K, the meter's offset must be set at 0,20 K.

Note: The set offset is active for all temperature sensors that are connected to MULTICAL® 603, i.e. both t1, t2 and t3.

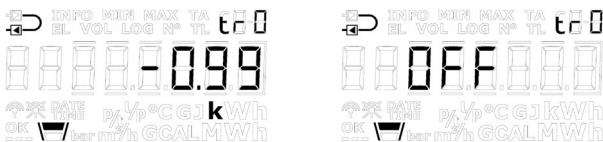

15. Radio on/off

The meter's radio/wireless communication can be adjusted to being switched on or switched off. The meter automatically turns on the radio when the meter leaves the transport state, i.e. when the meter has registered a flow of 1 % of q_p or larger. The radio on/off function in the "SETUP loop" is primarily used for switching on the radio in transport state, without the meter having registered flow, as well as for switching off the radio when the meter is dismantled after having been in operation, e.g. If the meter is to be sent by airfreight. The meter's present condition is indicated by two symbols in the bottom left corner of the display.

IMPORTANT:

- If the meter's radio communication is switched off via the SETUP loop, the meter will subsequently switch on the radio communication again when a flow of 1 % of q_p or larger has been registered for the first time.
- The symbols for radio on/off indicate whether the meter allows radio communication, not whether a radio module has activated its radio communication. Please be aware of this when troubleshooting the meter's wireless communication.

The above definition of the radio on/off symbols simplify the use of radio on/off in the "SETUP loop" too as it is possible to switch between radio on/off whether a module is mounted in the meter or not. This provides flexibility as the utility can configure the meter prior to mounting a module and thus ensure that radio by default is either switched on or switched off when the module is subsequently mounted.

If there is not mounted a module in the meter, or if the mounted module is not a radio module, both symbols will be turned off in the other loops of the meter, regardless of the setting of radio on/off in the "SETUP loop". MULTICAL® 603 always allows for radio communication during operation.

	Radio ON	Radio OFF	No module / not radio module
SETUP loop			
"USER loop" / "TECH loop"			

16. + 17. Inputs A1 and B1 (presetting of registers)

It is possible to preset the values of pulse inputs A1 and B1 in the "SETUP loop" so that the meter's display is in accordance with the connected water and/or electricity meters. The example is based on the connection of a water meter.



Note: If it is required to use the pulse inputs A2 and B2, METERTOOL HCW is used for presetting the registers.

18. + 19. Meter numbers of inputs A1 and B1

The meter numbers of the water and/or electricity meter connected to pulse inputs A1 and B1 can be adjusted in the "SETUP loop". The example shows the meter number connected to pulse input B1.

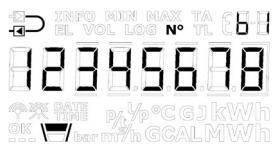

Note: If it is required to use the pulse inputs A2 and B2, METERTOOL HCW is used for setting the meter numbers.

20. + 21. + 22. Tariff limits (TL2, TL3 and TL4)

The meter's three tariff limits can be adjusted in the "SETUP loop". The tariff limits are only active if a tariff type has been selected during configuration of the meter, i.e. the EE-code differs from "00". The EE-code is shown in the "TECH loop", see paragraph 6.2. If a tariff type has been selected, the menu points reflect this by displaying the correct tariff limit units. If no tariff type has been selected the menu points will be without units. Read more about tariff types in paragraph 3.2.5.

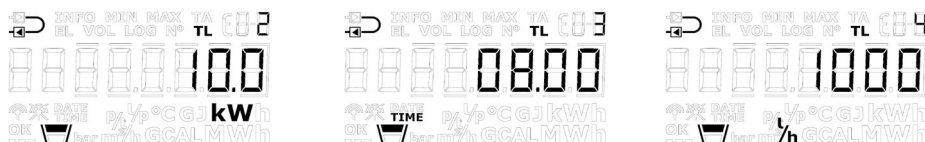

Note: It is *not* possible to have different types of tariff limits. The display readings shown are just examples.

MULTICAL® 603

23. Pre-setting t5

The temperature value t5 can be set in the interval 0,01...185,00 °C in the "SETUP loop". This value is used in connection with the calculation of outlet energy registers, i.e. registers A1 (A-, heat at a discount) and A2 (A+, heat with an addition). Read more about this calculation and function in paragraph 7.1.3.



24. EndSetup

The menu item "EndSetup" enables the technician to lock the access to the "SETUP loop" in transport state and thus lock the meter against further configuration. To do so, the user must keep the primary key activated for 5 seconds. During the five seconds the frames around the reading EndSetup will currently become illuminated in the meter's display. This action can be undone by releasing the primary key before the whole frame has become illuminated, i.e. before the 5 seconds have passed.

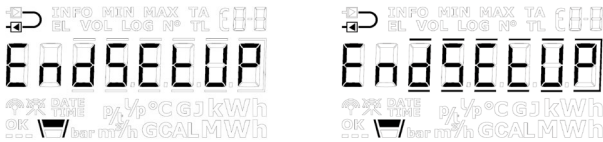

"EndSetup" is an important function when the meter is in transport state, but when the meter is in operation, "EndSetup" is just one of three ways to exit the "SETUP loop". See paragraph 6.3.

6.4 "TEST loop"

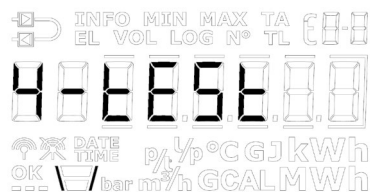

The "TEST loop" is e.g. used by authorized laboratories for reverification of the meter.



Before the meter can enter the "TEST loop" and thus the TEST mode, the verification seal marked "TEST" on the meter's verification cover must be carefully broken with a screwdriver and the contact points behind the seal be short-circuited. For this purpose, the short-circuit pen (6699-278) from Kamstrup A/S can be used.



The contact pads must be shorted while the calculator top is still active (display on). If it is not possible to keep the calculator top active, the recommendation is to remove the communication modules from the base, assemble the calculator and then open the calculator again and short the contact pads.

It is recommended to complete the work in the "TEST loop" before starting the reconfiguration via the "SETUP loop" or METERTOOL as every reconfiguration is logged in MULTICAL® 603 (it is only possible to reconfigure MULTICAL® 603 50 times).

The meter leaves the TEST mode and returns to the first reading in the "USER loop" after 9 hours (time-out), or if the user keeps the primary key activated for 5 seconds.

"TEST loop"				Display
Main		Sub		Index number in display
				
1.0	High-resolution heat energy ¹			4-001-00
		1.1	Heat energy (E1)	4-001-01
2.0	High-resolution cooling energy ¹			4-002-00
		2.1	Cooling energy (E3)	4-002-01
3.0	High-resolution volume V1 ¹			4-003-00
		3.1	Volume V1	4-003-01
4.0	t1 (inlet)			4-004-00
5.0	t2 (outlet)			4-005-00
6.0	Flow V1			4-006-00

¹ The resolution of the high-resolution registers appears from the table below.

The registers can only be reset by a total reset of the meter.

6.5 Registers and resolution

Energy and volume counted in the meter count registers in MULTICAL® 603 are displayed in normal resolution in the "USER loop". Normal resolution is available in four levels according to the selected CCC code and flow sensor size. The resolution levels are indicated in relation to selected display units in the table below.

Resolution level	Display					
	Normal resolution				High resolution	
	MWh Gcal	kWh	GJ	m ³ tons	kWh	l
3	0,0001	0,1	0,001	0,001	0,0001	0,001
2	0,001	1	0,01	0,01	0,001	0,01
1	0,01	-	0,1	0,1	0,01	0,1
0	0,1	-	1	1	0,1	1

Table 1: Normal and high resolution for meter count registers, depending on the CCC code

	Energy	Volume
Normal resolution	<p>030.9297 MWh</p>	<p>0787.332 m³</p>
High resolution	<p>929.7389 kWh</p>	<p>43324.40 l</p>

Table 2: Examples of normal and high resolution, flow sensor size qp 1,5 m³/h

While the calculator is in "TEST loop", all integrations are carried out with 2 second interval regardless of the L-code selected.

The above high-resolution registers can also be seen in the "TECH loop", see paragraph 6.2. Here, however, the integration interval will follow the calculator's normal interval, determined by the L-code.

While the meter is in "TEST loop", high-resolution pulses can be generated for test purposes via Pulse interface (see paragraph 13).

7 Calculator functions

7.1 Application types and energy calculations



MULTICAL® 603 operates with 15 different energy formulas, E1, E2, E3, E4, E5, E6, E7, E8, E9, E10, E11, A1, A2, dE(ΔE) and cE, which are all calculated parallel with each integration, irrespective of how the meter is configured. E8 and E9 are used as a basis of the calculation of average temperatures of inlet and outlet, whereas E1 and E3 are used for heat and cooling measurement, respectively. E4 to E7 are used in a number of energy applications that are shown below. A1 and A2 are used as a basis for discount/surcharge based on the outlet temperature (see paragraph 7.1.6).

Formula	ΔΘ	Example of application	Included in application no.	Register type
$E1=V1(t1-t2)k_{t1: Inlet / t2: Outlet}$	$t1 > t2$	Heat energy (V1 in inlet or outlet)	1+2+3+4+5+6+8+10	Legal Display/Data/Log
$E2=V2(t1-t2)k_{t2: Outlet}$	$t1 > t2$	Heat energy (V2 in outlet)	2+7	Display/Data/Log
$E3=V1(t2-t1)k_{t2: Inlet / t1: Outlet}$	$t2 > t1$	Cooling energy (V1 in inlet or outlet)	1+11	Legal Display/Data/Log
$E4=V1(t1-t3)k_{t1}$	$t1 > t3$	Forward energy	7+9+11	Display/Data/Log
$E5=V2(t2-t3)k_{t2}$	$t2 > t3$	Outlet energy or tap from outlet	5+7+9	Display/Data/Log
$E6=V2(t3-t4)k_{t3}$	$t3 > t4$	Tap water energy, separate	3+6	Display/Data/Log
$E7=V2(t1-t3)k_{t3}$	$t1 > t3$	Return energy or tap from flow	4+8	Display/Data/Log
$E8=V1[m^3] \times t1$	-	Average temperature in inlet	See paragraph 7.1.5.	Display/Data/Log
$E9=V1[m^3] \times t2$	-	Average temperature in outlet		Display/Data/Log
$E10=V1[m^3] \times t3$	-	Average t3 in V1		Display/Data/Log
$E11=V2[m^3] \times t3$	-	Average t3 in V2		Display/Data/Log
Additional registers				
A1	$t5 > t2$	Heat energy at a discount	See paragraph 7.1.6.	Display/Data/Log
A2	$t2 > t5$	Heat energy with an addition		Display/Data/Log
$dE(\Delta E)=E4-E5$	-	Differential energy	7	-
$cE=E5-E4$	-	Control of differential energy	7	-







MULTICAL® 603

7.1.1 Approvals for energy and applications

The symbols in the following table are used for specifying whether an energy calculation in a given application has been approved and for showing which approval is valid.

Symbol	Approval
	MID 2014/32/EU – Heat meter (EU)
	TS 27.02 – Cooling meter (EU)

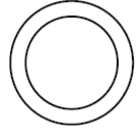
Symbols used in application figures

	Temperature sensor		Stop valve		Flow sensor
	Calculator		Consumer, e.g. radiators		Non-return valve
	Heat exchanger				

7.1.2 Components used in applications

The table below shows which components are necessary in the individual applications.

Application	Energy	System type		Flow sensor		Temperature sensors			
		Closed	Open	V1	V2	t1	t2	t3	t4
1	E1-E3	●		●		●	●		
2	E1-E2	●		●	●	●	●	⊙	
3	E1-E6	●	●	●	●	●	●	⊙	⊙
4	E1-E7	●		●	●	●	●	⊙	
5	E1-E5		●	●	●	●	●	⊙	
6	E1-E6		●	●	●	●	●	⊙	⊙
7	E2-E4-E5-dE(ΔE)		●	●	●	●	●	⊙	
8	E1-E7		●	●	●	●	●	●	
9	E4-E5	●		●	●	●	●	●	
10	E1		●	●		●	⊙		
11	E3-E4	●		●		●	●	●	

7.1.3 Application drawings

Energy types E1...E16 are described by application examples below.

	<p>Application no. 1</p> <p>Closed thermal system with 1 flow sensor</p> <ul style="list-style-type: none"> ② Heat energy: $E1 = V1(t1-t2)k_{t1:inlet \text{ or } t2:outlet}$ ⑤ Cooling energy: $E3 = V1 (t2-t1)k_{t1:inlet \text{ or } t2:outlet}$ <p>Flow sensor V1 is mounted in inlet or outlet as selected during configuration.</p> <p>Mass: $M1 = V1 (K_{mass} t1)$ or Mass: $M1 = V1 (K_{mass} t2)$ depending on inlet/outlet programming.</p> <p>Config A = 3 (inlet) or 4 (outlet)</p>
	<p>Application no. 2</p> <p>Closed thermal system with 2 identical flow sensors Leakage monitoring and Permanent operational monitoring</p> <ul style="list-style-type: none"> ② Billing energy: $E1 = V1(t1-t2)k_{t1:Inlet}$ <p>Control energy: $E2 = V2 (t1-t2)k_{t2:Outlet}$</p> <p>t3 can be used for check measurement of either the inlet or outlet temperature, but t3 is not used for the energy calculation.</p> <p>Mass: $M1 = V1 (K_{mass} t1)$ Mass: $M2 = V2 (K_{mass} t2)$</p> <p>Config. A = 3 (Inlet)</p>

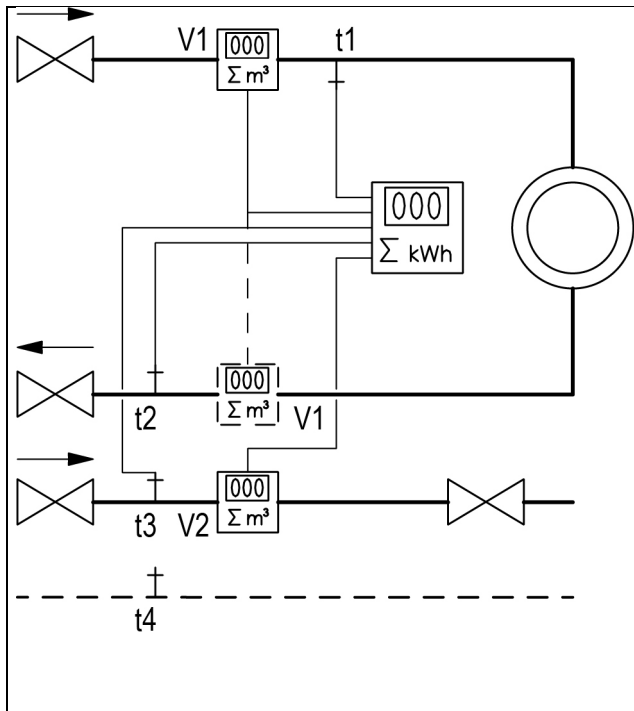

Application no. 3

2 string system with 2 flow sensors

② Heat energy: $E1 = V1(t1-t2)k_{t1:inlet \text{ or } t2:outlet}$

Tap water energy: $E6 = V2 (t3-t4)k_{t3}$

t3 is measured or programmed
t4 is programmed.

Flow sensor V1 is mounted in inlet or outlet as selected during configuration.

Mass: $M1 = V1 (K_{mass} t1)$ or
Mass: $M1 = V1 (K_{mass} t2)$ depending on inlet/outlet programming.
Mass: $M2 = V2 (K_{mass} t3)^*$

Config A = 3 (inlet) or 4 (outlet)

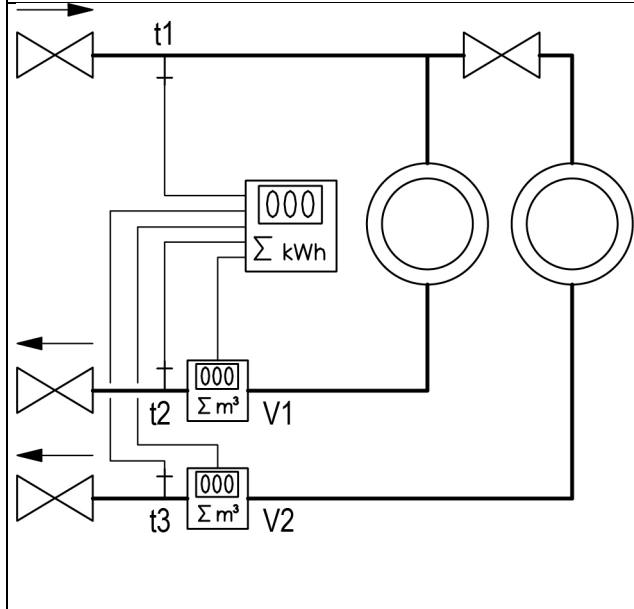

Application no. 4

2 heating circuits with joint forward pipe

② Heat energy #1: $E1 = V1(t1-t2)k_{t2}$

Heat energy #2: $E7 = V2(t1-t3)k_{t3}$

t3 is measured or programmed

Mass: $M1 = V1 (K_{mass} t2)$
Mass: $M2 = V2 (K_{mass} t3)^*$

Config. A = 4 (outlet)

* $M2 = V2 (K_{mass} t3)$. V2 is mass-adjusted with t3 when selecting special DDD-code.

	<p>Application no. 5</p> <p>Open system with tapping from return pipe</p> <p>Heat energy: $E1 = V1(t1-t2)k_{t1}$</p> <p>Tap water energy: $E5 = V2 (t2-t3)k_{t2}$</p> <p>$t3$ is measured or programmed</p> <p>Mass: $M1 = V1 (K_{mass} t1)$ Mass: $M2 = V2 (K_{mass} t2)$</p> <p>Config. A = 3 (Inlet)</p>
	<p>Application no. 6</p> <p>Open system with separate flow sensor for tapping</p> <p>Heat energy: $E1 = V1(t1-t2)k_{t2}$</p> <p>Tap water energy: $E6 = V2 (t3-t4)k_{t3}$</p> <p>$t3$ is measured or programmed $t4$ is programmed.</p> <p>Mass: $M1 = V1 (K_{mass} t2)$ Mass: $M2 = V2 (K_{mass} t3)^*$</p> <p>Config. A = 4 (outlet)</p>

* $M2 = V2 (K_{mass} t3)$. $V2$ is mass-adjusted with $t3$ when selecting special DDD-code.

	<p>Application no. 7</p> <p>Open system with 2 flow sensors</p> <p>Forward energy: $E4 = V1 (t1-t3)k_{t1}$</p> <p>Return energy: $E5 = V2 (t2-t3)k_{t2}$</p> <p>$dE(\Delta E) = E4-E5$ can be calculated by the meter.</p> <p>Heat energy: $E2 = V2 (t1-t2)k_{t2}$</p> <p>$t3$ is measured or programmed</p> <p>Mass: $M1 = V1 (K_{mass} t1)$ Mass: $M2 = V2 (K_{mass} t2)$</p> <p>Config A = 3 (inlet) or 4 (outlet) No influence on E2, E4 or E5</p>
	<p>Application no. 8</p> <p>Hot-water boiler with circulation</p> <p>Total consumption $E1 = V1 (t1-t2)k_{t2}$</p> <p>Circulated consumption: $E7 = V2 (t1-t3)k_{t3}$</p> <p>Mass: $M1 = V1 (K_{mass} t2)$ Mass: $M2 = V2 (K_{mass} t3)^*$</p> <p><i>LV: Hot domestic water</i> <i>LVK: Heat circulation</i> <i>KV: Cold water</i></p> <p>Config. A = 4 (outlet)</p>

* $M2 = V2 (K_{mass} t3)$. $V2$ is mass-adjusted with $t3$ when selecting special DDD-code.

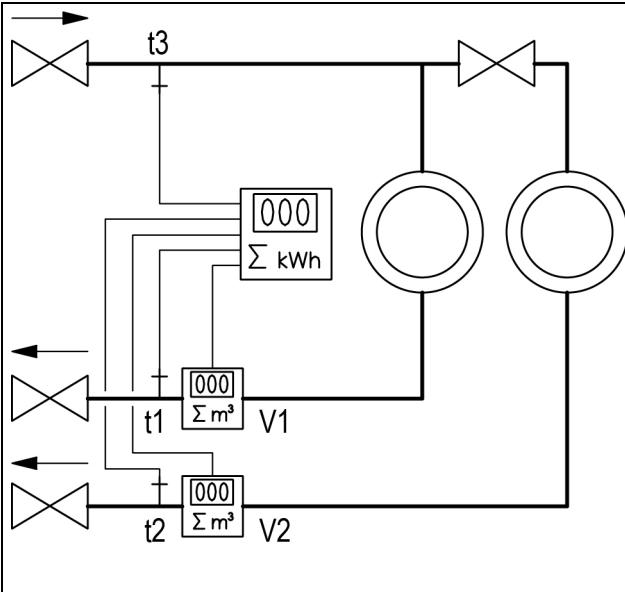

Application no. 9

2 cooling circuits with joint forward pipe

Cooling energy #1: $E4 = V1(t1-t3)k_{t1}$

Cooling energy #2: $E5 = V2(t2-t3)k_{t2}$

Mass: $M1 = V1 (K_{mass} t1)$

Mass: $M2 = V2 (K_{mass} t2)$

Config A = 3 (inlet) or 4 (outlet)

No influence on E2, E4 or E5

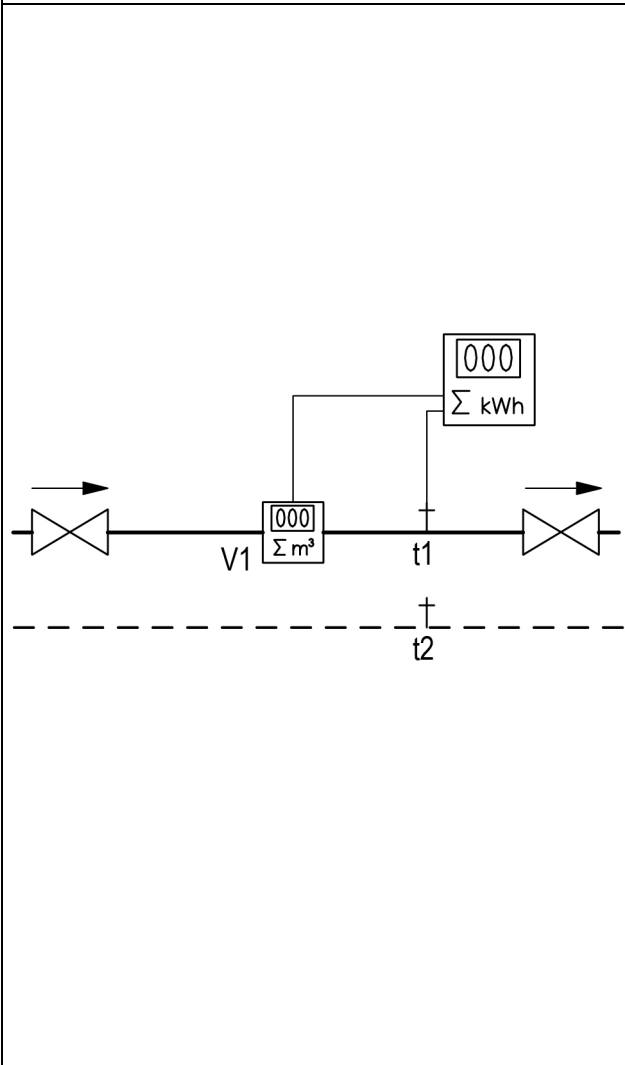

Application no. 10

Energy of domestic hot water

Tap water energy: $E1 = V1 (t1-t2)k_{t1}$

Mass: $M1 = V1 (K_{mass} t1)$

t1 and t2 are measured with 2-wire sensors or 4-wire sensors.

Alternative:

t2 is programmed with a fixed temperature value or t2 is programmed via the scheduler function that is built into MULTICAL® 603. The temperature t2 follows a table, within which t2 can be changed up to 12 times a year.

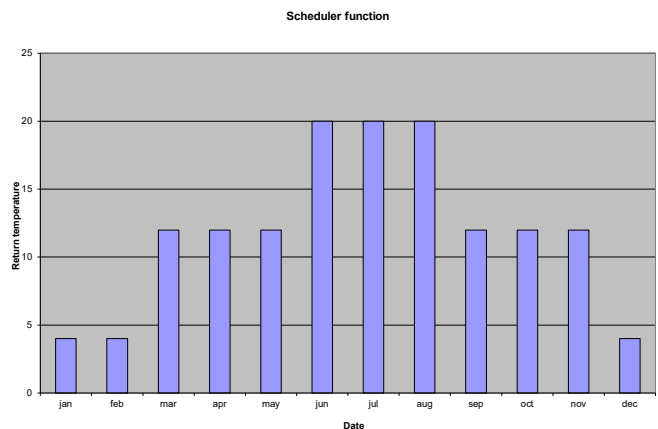

Config. A = 3 (Inlet)

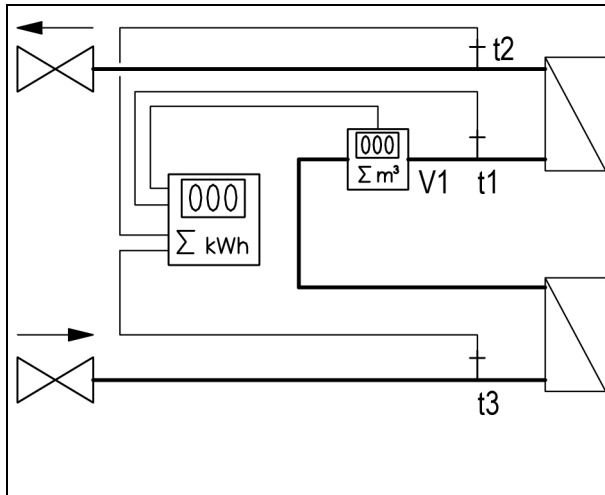

Application no. 11

2-stage boiler system with 1 flow sensor

Boiler energy "B": $E3 = V1 (t2-t1)k_{t1}$
(Upper boiler)

Boiler energy "A": $E4 = V1(t1-t3)k_{t1}$
(Lower boiler)

Config. A = 4 (outlet)

7.1.4 Energy calculations and registers E1 and E3

MULTICAL® 603 calculates energy on the basis of the formula stated in EN 1434-1, which uses the international temperature scale issued in 1990 (ITS-90) and the pressure definition of 16 bar.

In a simplified form the energy calculation can be expressed as: Energy = V x ΔΘ x k. The calculator always calculates energy in [Wh], and then converts the value to the selected measuring unit.

E [Wh] =	V x ΔΘ x k x 1000
E [kWh] =	E [Wh] / 1.000
E [MWh] =	E [Wh] / 1.000.000
E [GJ] =	E [Wh] / 277.800

V is the added (or simulated) water volume in m³

ΔΘ is the measured temperature difference: Heat energy (E1) ΔΘ = inlet temperature less outlet temperature
Cooling energy (E3) ΔΘ = outlet temperature less inlet temperature

k is the heat coefficient of water, calculated according to the formula of EN 1434 and OIML R75-1:2002

Both in the display and during data reading each energy type is uniquely defined, e.g.

Heat energy: E1 = V1(t1-t2)k

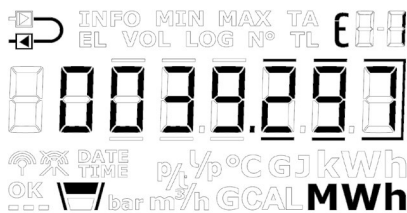

Cooling energy: E3 = V1(t2-t1)k

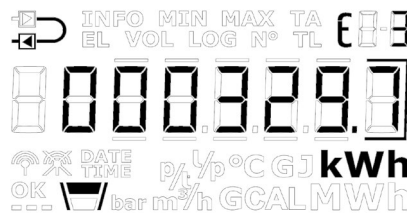

Kamstrup A/S can supply an energy calculator for check measurement:

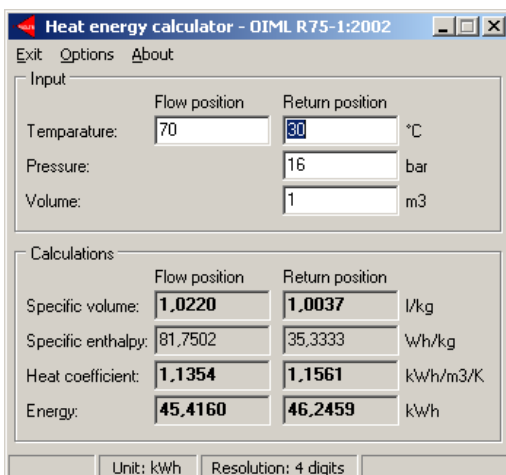

		Calculation	Condition
Heat energy (E1, A1, A2)	Inlet	$E1 = m^3 \times (t1-t2)k_{t1}$ $A1 = m^3 \times (t5-t2)k_{t1}$ $A2 = m^3 \times (t2-t5)k_{t1}$	$t1 > t2$ If $t1 = t2$, then $E1, A1, A2 = 0$ If $t5-t2 \leq 0$, then $A1 = 0$ If $t2-t5 \leq 0$, then $A2 = 0$ $\theta_{t1} > \theta_{hc}$ (meter type 6)
	Outlet	$E1 = m^3 \times (t1- t2)k_{t2}$ $A1 = m^3 \times (t5-t2)k_{t2}$ $A2 = m^3 \times (t2-t5)k_{t2}$	$t1 > t2$ If $t1 = t2$, then $E1, A1, A2 = 0$ If $t5-t2 \leq 0$, then $A1 = 0$ If $t2-t5 \leq 0$, then $A2 = 0$ $\theta_{t1} > \theta_{hc}$ (meter type 6)
Cooling energy (E3)	Inlet	$E3 = m^3 \times (t2- t1)k_{t1}$	$t1 < t2$ $\theta_{t1} > \theta_{hc}$ (meter type 6)
	Outlet	$E3 = m^3 \times (t2 - t1)k_{t2}$	$t1 < t2$ $\theta_{t1} > \theta_{hc}$ (meter type 6)
Inlet/outlet energy (E8, E9, E10, E11)		$E8 = V1[m^3] \times t1$ $E9 = V1[m^3] \times t2$ $E10 = V1[m^3] \times t3$ $E11 = V2[m^3] \times t3$	

In case of an error on temperature sensor t1, t2 or t3, the counting stops in the registers, which are influenced by the error. Furthermore, the displayed reading in question will include lines.

	t1 error	t2 error	t3 error	V1 Flow error	V2 Flow error
t1 inlet	Display - - -				
t2 outlet		Display - - -			
Δt (t1-t2)	Display - - -	Display - - -			
t3			Display - - -		
Flow, V1					
Power, V1	Display - - -	Display - - -			
E1	No counting	No counting			
E2	No counting	No counting			
E3	No counting	No counting			
E4	No counting		No counting		
E5		No counting	No counting		
E6			No counting		
E7	No counting		No counting		
E8	No counting				
E9		No counting			
E10			No counting		
E11			No counting		
V1					
V2					
A1	No counting	No counting			
A2	No counting	No counting			

MULTICAL® 603

7.1.5 Energy calculations and registers E8, E9, E10 and E11

E8 and E9 are used as a basis for calculating the volume-based average temperatures of inlet and outlet respectively. With every integration, the registers are accumulated by the product of $m^3 \times ^\circ C$, which makes E8 and E9 a suitable basis for the calculation of volume-based average inlet and outlet temperatures.

E10 and E11 function in the same way as E8 and E9, but are used for calculating the average t_3 in either V1 or V2.

E8, E9, E10 and E11 can be used for the average calculation during any period of time as long as the volume register is read at the same time as the energy registers.

$$E8 = V1[m^3] \times t1$$

E8 is increased by the product of m^3 for V1 x t1

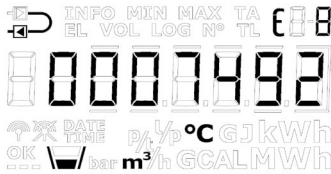

$$E9 = V1[m^3] \times t2$$

E9 is increased by the product of m^3 for V1 x t2

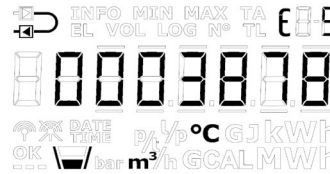

$$E10 = V1[m^3] \times t3$$

E10 is increased by the product of m^3 for V1 x t3

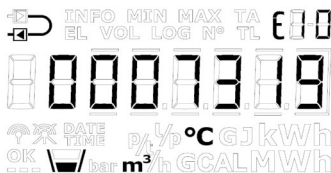

$$E11 = V2[m^3] \times t3$$

E11 is increased by the product of m^3 for V2 x t3

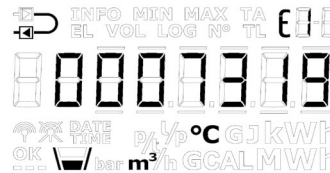

Resolution of E8, E9, E10 and E11

E8, E9, E10 and E11 depend on the volume resolution $[m^3]$

Volume resolution	E8, E9, E10 and E11 resolutions
0000,001 m^3	$m^3 \times ^\circ C \times 10$
00000,01 m^3	$m^3 \times ^\circ C$
000000,1 m^3	$m^3 \times ^\circ C \times 0,1$
0000001 m^3	$m^3 \times ^\circ C \times 0,01$

Example 1: Within a year a heating installation has used 250,00 m^3 district heating water and the average temperatures have been 95 $^\circ C$ in inlet and 45 $^\circ C$ in outlet.

E8 = 23750 and E9 = 11250.

Example 2: The average temperatures are to be measured together with the yearly reading. Therefore, E8 and E9 are included in the yearly reading.

Reading date	Volume	E8	Average of inlet	E9	Average of outlet
2017.06.01	534,26 m^3	48236		18654	
2016.06.01	236,87 m^3	20123		7651	
Yearly consumption	297,39 m^3	28113	28113/297.39 = 94,53 $^\circ C$	11003	11003/297.39 = 36,99 $^\circ C$

Table 3

7.1.6 Outlet energy registers A1 and A2

The function behind the “Outlet energy registers” is that A1 accumulates heat energy consumed with low outlet temperature for which the customer receives a discount, and A2 accumulates heat energy consumed with high outlet temperature for which the consumer receives a surcharge.

The energy calculations of a heat meter with flow sensor in outlet are shown below:

$$A1 = m^3 \times (t5 - t2) k_{t2} \quad \text{Heat energy with discount}$$

$$A2 = m^3 \times (t2 - t5) k_{t2} \quad \text{Heat energy with surcharge}$$

The energy is calculated only by positive temperature difference.

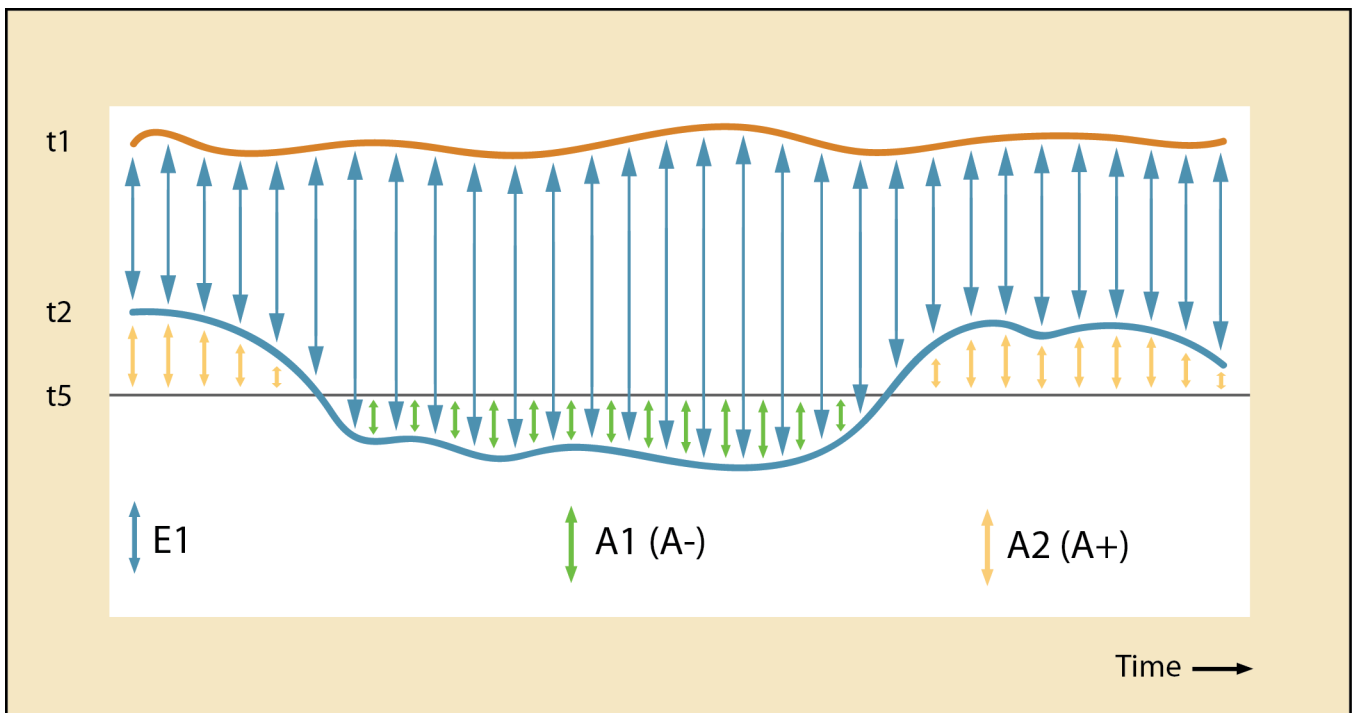

The outlet temperature reference $t5$ can be factory-configured as required, or can be changed via METERTOOL HCW after delivery. Typical configuration is $t5 = 50 \text{ }^\circ\text{C}$.

Symbol	Explanation	Measuring unit
$t1$	Inlet temperature	[$^\circ\text{C}$]
$t2$	Outlet temperature	
$t5$	Outlet temperature reference	
E1	Total heat energy	[kWh], [MWh], [GJ], [Gcal]
A1	Heat energy at a discount	
A2	Heat energy with an addition	

As the accuracy of the absolute temperature has direct influence on the accuracy of outlet energy registers A1 and A2, the zero error of the sensor pair and the influence from the sensors' connection cable ought to be compensated via the offset adjustment of MULTICAL® 603 (see paragraph 7.3).

7.2 Measurement of a heat pump's coefficient of performance

7.2.1 Coefficient of Performance (CP)

In houses with heat pumps, with a common heat circuit, it is appropriate to measure both the released thermal energy and the gained electrical energy, based on which the coefficient of performance (COP or CP) can be calculated. CP is the abbreviation of “Coefficient Of Performance”.

The calculation is based on simple proportional numbers between the calculated thermal energy (E1) and the electrical energy, which is measured via pulse input B (In-B1):

$$CP = \frac{\text{Thermal energy [E1]}}{\text{Electric energy [Input B1]}}$$

The electrical energy (In-B1) is always registered in kWh or MWh, whereas the thermal energy (E1) is either registered in kWh, MWh, Gcal or GJ depending on the selected B-code. No matter which unit you choose, the meter calculates CP correctly. The CP value is displayed with one decimal and is a value in the interval 0.0...19.9.

The CP value can be displayed, respectively, as a current value, a monthly value or a yearly value (SCOP, Seasonal Coefficient Of Performance). In addition, the averaging period of the current CP value as well as the actual power measured at pulse input B1 can be displayed.



Current CP is averaged over a number of days and nights selected in the meter’s configuration. The averaging period can be selected in the interval 5...30 days and nights. The averaging period is set at 7 days and nights, unless otherwise stated by the customer.

Note: If data of E1 or In-B1 is missing for a logging period, the current CP is displayed as 0.0 until the data basis is sufficient.

CP display readings

The table below shows the CP readings in the “TECH loop”.

Primary reading	Secondary reading	Display no.	Display reading
CP (moving average)		2-023-00	
	Actual power of In-B1	2-023-01	
	Averaging period of CP	2-023-02	
	Yearly date	2-023-03	
	Yearly data	2-023-04	

Primary reading	Secondary reading	Display no.	Display reading
	Monthly date	2-023-05	
	Monthly data	2-023-06	

Reset of CP

Situation	Handling
Different units and/or resolutions of E1 and In-B1	Correction for the difference in CP calculation
Reconfiguration of unit and/or resolution of E1 (the B- or CCC-code)	Reset of CP calculations ¹
Reconfiguration of unit and/or resolution of In-B1 (the GG-code)	Reset of CP calculations ¹
Reconfiguration of pre-setting of In-B1	Reset of CP calculations ¹

¹ Monthly and yearly CP restart, i.e. CP is calculated over just the remaining period until the next logging. Current CP is set to 0.0 until the daily log has logged over the configured number of days (if number of days, for example, is set to 5, the meter cannot make a calculation over 5 days until it has carried out 6).

7.2.2 Seasonal Coefficient of Performance (SCOP)

SCOP is an average measurement of the heat pump's coefficient of performance, which indicates how efficient it is on a yearly basis. The average yearly value is measured over a year (one season) in which the heat pump has experienced both high and low ambient temperatures.

By selecting logger profile (RR-code), it is possible to save both yearly and monthly values. The monthly values are calculated as the average of a full month, and the yearly values are calculated as the average of a full year. Month and year are determined by the selected target date.

7.2.3 Measurement of the coefficient of performance (CP) of a gas boiler

If the pulse output of a gas meter is connected to a heat meter, the coefficient of performance of the gas boiler can be measured, in terms of e.g. kWh/Nm³ gas. A volume resolution which corresponds to the pulse weighting on the gas meter pulse output must then be selected for input B1.

7.3 Offset adjustment of temperature sensor measurement

MULTICAL® 603 is available with possible offset adjustment of the temperature sensor measurement, thus increasing the accuracy of the absolute temperature measurement. This is especially relevant in the installation scenario in which the calculator is to be used for tariff billing based on absolute temperatures. In that case, it is an EN 1434 requirement that the accuracy of the calculator’s absolute temperature reading must be within ± 1.0 K. Offset adjustment is extremely relevant in district cooling installations too. In district cooling installations, the customer often requires a maximum inlet temperature. Absolute temperature measurement with undesirable inaccuracy can cause the supplier to supply water with a lower inlet temperature than promised, resulting in unnecessary extra costs for the supplier.

Depending on the meter’s configuration, offset adjustment can be programmed into the meter from the factory. Offset can also be adjusted after delivery via the meter’s "SETUP loop" (see paragraph 6.3) or via METERTOOL HCW. See Technical description for METERTOOL HCW (5512-2097).

Note: Depending on the calculator’s configuration, the offset adjustment can be disabled and the menu item in the "SETUP loop" will in that case display "OFF".

If the temperature sensor pair of a calculator with offset adjustment is replaced, it is recommended to correct the offset so that it matches the newly connected sensor pair. Alternatively, offset should be adjusted to 0.00 K, which means that the function is switched off and does not contribute to an undesirable increase of the error of the absolute temperature measurements.

The temperature sensor offset (t_{r0}) can be adjusted in the interval -0,99...0,99 K according to the calculator’s approval.

Note that the required offset adjustment must be entered, not the error of the temperature sensor pair.
If the selected temperature sensor pair contributes with an error of -0,20 K, the meter’s offset must be set to 0,20 K.

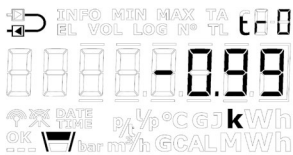

7.4 Bifunctional heat/cooling metering

MULTICAL® 603 is available as heat meter (meter type 2), cooling meter (meter type 5) or bifunctional heat/cooling meter (meter type 3 and 6).

Meter type

Heat meter (MID modules B+D)		2
Heat/cooling meter (MID modules B+D & TS+DK268)	$\Theta_{hc} = \text{OFF}$	3
Cooling meter (TS27.02+DK268)		5
Heat/cooling meter (MID module B+D & TS27.02+DK268)	$\Theta_{hc} = \text{ON}$	6
Country code (language on label etc.)		XX

If MULTICAL® 603 has been supplied as a heat/cooling meter (meter type 3 and 6), heat energy (E_1) is measured at a positive temperature difference ($t_1 > t_2$) whereas cooling energy (E_3) is measured at a negative temperature difference ($t_1 < t_2$). Temperature sensor t_1 (indicated with a black line in a red field) is mounted in the inlet, whereas t_2 (indicated with two black lines in a blue field) is mounted in the outlet.

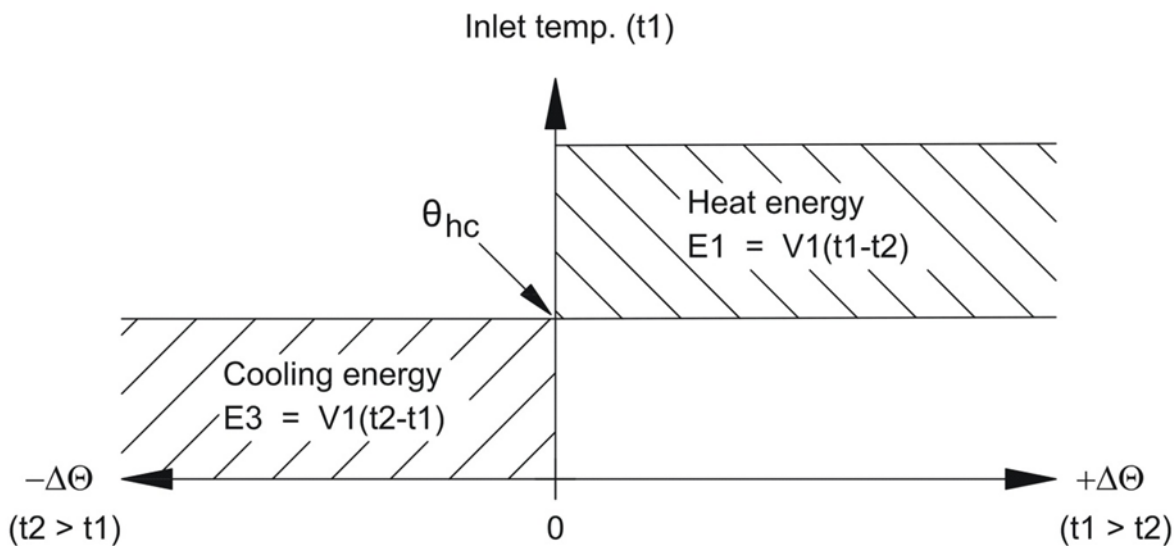

θ_{hc} functions as a limit value for the measurement of heat/cooling energy. With θ_{hc} enabled, heat energy is only measured when t_1 is greater than or equal to θ_{hc} . Likewise, cooling energy is only measured if the inlet temperature t_1 is lower than θ_{hc} .

In heat/cooling meters, the limit value θ_{hc} should be set at the highest temperature which has appeared in the inlet in connection with cooling, e.g. 25 °C. Thereby, the differential temperature alone decides whether cooling or heat energy is invoiced.

Configuration of the function θ_{hc} is only possible in meter type 6. Configuration is possible in the interval 0,01..180,00 °C. In order to disable θ_{hc} , it must be configured at 250,00 °C. In other meters than meter type 6, θ_{hc} is permanently "Off" in the configuration. θ_{hc} is configured via the "SETUP loop" or by means of the PC-program METERTOOL HCW, see paragraph 6.3 and read more about METERTOOL HCW in Technical description (5512-2097).

Note: There is no hysteresis in connection with shift between heat and cooling energy measurement ($\Delta\theta_{hc} = 0,00$ K).

7.5 Min/max calculations of power (P) and flow (Q)

MULTICAL® 603 registers minimum and maximum flow and power on both monthly and yearly basis. The registration can be read in full via data communication. Furthermore, the two latest yearly registrations and the latest 12 monthly registrations can be read in the "USER loop". It depends on the selected display code (DDD-code) whether these registrations are displayed in the "USER loop". Read more about the DDD-code in paragraph 3.2.4.

The display can show the current minimum and maximum registration of present year and month. In addition historical data, i.e. minimum and maximum values registered for previous year and months can be displayed. The dates, on which minimum or maximum values were measured, are displayed in format 20YY.MM.DD. Using serial reading the time (hh.mm.ss) can be included too. Below you see the complete overview of the registers.

Note: Historical readings (logging values) are not part of the "TECH loop". They are only displayed in the "USER loop", and only if the DDD-code in question includes these readings.

Flow (V1)	"USER loop"	
12.1		<i>Date of max this year</i>
12.2		<i>Data of max this year</i>
12.3		<i>Date of max yearly logger</i>
12.4		<i>Data of max yearly logger</i>
12.5		<i>Date of max this month</i>
12.6		<i>Data of max this month</i>
12.7		<i>Date of max monthly logger</i>
12.8		<i>Data of max monthly logger</i>
12.9		<i>Date of min. this year</i>
12.10		<i>Data of min. this year</i>
12.11		<i>Date of min. yearly logger</i>
12.12		<i>Data of min. yearly logger</i>
12.13		<i>Date of min. this month</i>
12.14		<i>Data of min. this month</i>
12.15		<i>Date of min. monthly logger</i>
12.16		<i>Data of min. monthly logger</i>

Thermal power (V1)	"USER loop"	
14.1		<i>Date of max this year</i>
14.2		<i>Data of max this year</i>
14.3		<i>Date of max yearly logger</i>
14.4		<i>Data of max yearly logger</i>
14.5		<i>Date of max this month</i>
14.6		<i>Data of max this month</i>
14.7		<i>Date of max monthly logger</i>
14.8		<i>Data of max monthly logger</i>
14.9		<i>Date of min. this year</i>
14.10		<i>Data of min. this year</i>
14.11		<i>Date of min. yearly logger</i>
14.12		<i>Data of min. yearly logger</i>
14.13		<i>Date of min. this month</i>
14.14		<i>Data of min. this month</i>
14.15		<i>Date of min. monthly logger</i>
14.16		<i>Data of min. monthly logger</i>

Below are examples of display readings of the date and data readings. The frames around the date indicate whether the date is connected to yearly or monthly data. In data readings of yearly data the last two digits of the year are marked in frames, whereas the two digits for month are marked for monthly data. Furthermore, the symbols "MIN" and "MAX" are illuminated to indicate whether the values are minimum or maximum values. The symbol "LOG" is illuminated for historical readings.

Examples of yearly date and data (max values) for flow

Date of max this year

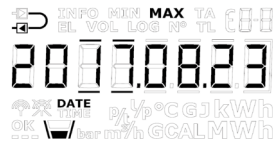

Data of max this year

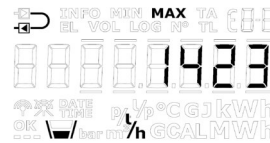

Date of max yearly logger

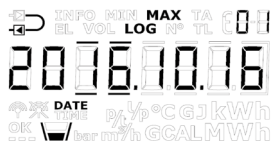

Data of max yearly logger

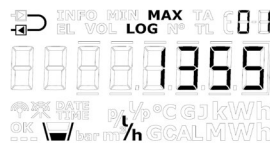

Examples of monthly date and data (min. values) for power

Date of min. this month

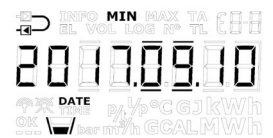

Data of min. this month

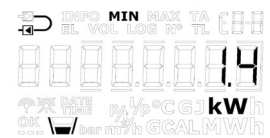

Date of min. monthly logger Data of min. monthly logger

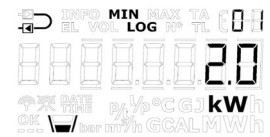
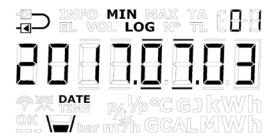

All minimum and maximum values are calculated as the average of a number of actual flow or power measurements depending on the chosen averaging period. All calculated flow and power values from the averaging period are used in the calculation of the average. Calculated values are compared to previous values, and the new value is saved if it exceeds the previous maximum value or is lower than the previous minimum value. The averaging period used in all calculations can be selected in the interval 1...1440 minutes in leaps of 1 minute (1440 min. = 24 hours). The averaging period and the target dates are stated in the order. Read more about order data in paragraph 3.3. If not otherwise stated in the order, the default averaging period of 60 minutes is used. This value can later be changed via the "SETUP loop" or METERTOOL HCW.

Please note the following:

- In the display the date is shown in the format 20YY.MM.DD, but by serial reading the time can be stated too, and the format then becomes YY.MM.DD, hh.mm.ss.
- The average is calculated continuously over time, i.e. the average of values is calculated from now on and back in time according to the chosen averaging period. As a result, the min/max calculation is immune to the clock setting and will always move continuously through time.

7.6 Temperature measurement

Inlet and outlet temperatures are measured by means of an accurately matched Pt500 or Pt100 sensor pair. During each temperature measurement MULTICAL® 603 sends measuring current through each sensor. The current is approx. 0,5 mA for Pt500 and approx. 2,5 mA for Pt100. Two measurements are carried out in order to suppress possible 50 Hz (or 60 Hz) low-frequency noise picked up via the sensor cables. Furthermore, current measurements are made by internal reference resistors in order to secure optimum measuring stability.

The display presents inlet and outlet temperatures as well as temperature difference in range 0,00 °C to 185,00 °C. The temperature difference is presented in the range 0,01 K to 185,00 K.

By default, the meter has no cut-off for low temperature and thus measures down to 0,01 °C and 0,01 K. If required, it is possible, when ordering the meter, to program a cut-off for the temperature difference ($\Delta\theta$) in the range 0,01...2,50 K. It is not possible to program this with METERTOOL. If the meter is programmed with a cut-off of 2,50 K, it will not calculate energy and volume at a temperature difference below 2,50 K.

Note Cut-off for the temperature difference should be distinguished from θ_{hc} , which functions as a limit value of the heat/cooling energy measurement. See paragraph 7.4.

Inlet or outlet temperatures below 0 °C and above 185 °C are indicated as lines in the display, but serial reading includes 0,00 °C and 185,00 °C respectively. If one or both temperature sensors are outside the measuring range, the info code is set as shown in paragraph 7.7.

At negative temperature difference (inlet < outlet) the temperature difference is displayed with a negative sign and cooling energy is calculated. It depends on the selected DDD-code whether the temperature difference is shown in the display.

Measuring current and power

Measuring current is only sent through the temperature sensors during the short duration of the temperature measurement. The effective power that is deposited in the sensor elements is thus very small, and its influence on self-heating of the temperature sensors is typically less than 1/1000 K.

	Pt100	Pt500
Measuring current	< 2,5 mA	< 0,5 mA
Peak power	< 1,0 mW	< 0,2 mW
RMS influence (fast mode)	< 10 μ W	< 2 μ W
RMS influence (normal mode)	< 2 μ W	< 0,4 μ W

Average temperatures

MULTICAL® 603 continuously calculates the average temperatures of inlet and outlet (t_1 and t_2) in °C without decimals, and background calculations E8, E9, E10 and E11 are carried out with every volume calculation (e.g. with every 0,01 m³ at a meter size of q^p 1,5), whereas the display is updated with every integration (depending on the L-code). The average calculations are thus volume weighted and can be used directly for checking purposes.

Pre-programmed temperatures

The temperature t_3 can either be measured or pre-programmed in the calculator's memory, whereas the temperatures t_4 and t_5 only can be pre-programmed. See paragraphs 7.1 and 7.12 for examples of using these additional temperatures.

2-wire sensor connection

MULTICAL® 603-A has 2-wire Pt100 connection, whereas MULTICAL® 603-C/E/F has 2-wire Pt500 connection. It applies to all 2-wire sensor connections that the cable lengths and cross sections of the two sensors which are used as temperature sensor pair for a heat or cooling meter must always be identical, and that cable sensors must neither be shortened nor extended.

The limitations connected to the use of 2-wire sensor pairs according to EN 1434-2 appear from the table below. In addition, the table indicates how big error the longer 2-wire cables will result in.

Kamstrup supplies Pt500 sensor sets with up to 10 m cable (2 x 0.25 mm²).

Cable cross section [mm ²]	Pt100 sensors		Pt500 sensors	
	Max cable length [m]	Error display ¹ [K/m]	Max cable length [m]	Error display ¹ [K/m]
0,25	2,5	0,450	12,5	0,090
0,50	5,0	0,200	25,0	0,040
0,75	7,5	0,133	37,5	0,027

Table 4

¹ The error is calculated for copper cable at 20 °C. At higher cable temperatures, the error will be bigger.

MULTICAL® 603 has a temperature sensor offset function, see paragraph 7.3, which can be used to reduce the error that derives from the cable resistance and the zero error of the sensors.

4-wire sensor set

For installations requiring longer cables than listed in the table above, it is recommended to use 4-wire sensor sets. MULTICAL® 603-B has 4-wire Pt100 connection, whereas MULTICAL® 603-D/G/H has 4-wire Pt500 connection.

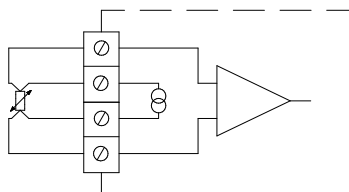

MULTICAL® 603 has a “real” 4-wire construction, which uses two conductors for the measuring current and two other conductors for the measuring signal, which means that the construction is in theory uninfluenced by long sensor cables. In practice, cables ought not to be longer than 100 m, and it is recommended to use 4 x 0.25 mm². As the 4-wire signal inputs have a very high impedance, a disconnected wire could lead to an arbitrary temperature and the information code “Above the measuring range” (disconnected) or “Below the measuring range” (short-circuited) would be displayed.

7.7 Information code types

MULTICAL® 603 constantly monitors a number of important functions. If a serious error occurs in measuring system or installation, a flashing “INFO” will appear in the display. The “INFO” field keeps flashing as long as the error is present no matter which reading you choose. The “INFO” field automatically disappears when the reason for the error has been removed.

Note: Configuration for “Manual reset of info code” is not possible in MULTICAL® 603

7.7.1 Information code types in display

In MULTICAL® 603 each digit of the info code is dedicated to one of the meter’s part elements. For example, the second digit from the left in the display is always related to information on temperature sensor t1. At the same time, the info code is section divided so that it from left to right consists of: general information, temperature information (t1, t2, t3), flow information (V1, V2) and information about the pulse inputs A and B (In-A1/A2 and In-B1/B2). See the table below for an overview of the info codes and response times.

Display digit								Description	Response time to activ INFO
1	2	3	4	5	6	7	8		
Info	t1	t2	t3	V1	V2	In-A	In-B		
1								No voltage supply ¹	-
2								Low battery level	< 1 day
9								External alarm (e.g. via KMP)	< 1 second
	1							t1 Above measuring range or disconnected ³	< 3 minutes
		1						t2 Above measuring range or disconnected ³	< 3 minutes
			1					t3 Above measuring range or disconnected ³	< 3 minutes
	2							t1 Below measuring range or short-circuited ³	< 3 minutes
		2						t2 Below measuring range or short-circuited ³	< 3 minutes
			2					t3 Below measuring range or short-circuited ³	< 3 minutes
	9	9						t1-t2 Invalid temperature difference	< 3 minutes
				1				V1 Communication error ⁴	< 1 day
					1			V2 Communication error ⁴	< 1 day
				2				V1 Wrong pulse figure	< 1 day
					2			V2 Wrong pulse figure	< 1 day
				3				V1 Air	< 1 day
					3			V2 Air	< 1 day
				4				V1 Wrong flow direction	< 1 day
					4			V2 Wrong flow direction	< 1 day
				6				V1 Increased flow (flow1 > qs, for more than 1 hour)	< 1 hour
					6			V2 Increased flow (flow2 > qs, for more than 1 hour)	< 1 hour
				7				V1/V2 Burst, water loss (flow1 > flow2)	< 120 seconds
					7			V1/V2 Burst, water penetration (flow1 < flow2)	< 120 seconds
				8				V1/V2 Leakage, water loss (M1 > M2)	< 1 day
					8			V1/V2 Leakage, water penetration (M1 < M2)	< 1 day
						7		In-A2 Leakage in the system	< 1 day
						8		In-A1 Leakage in the system	< 1 day
						9		In-A1/A2 External alarm	< 5 seconds
							7	In-B2 Leakage in system ²	< 1 day
							8	In-B1 Leakage in system ²	< 1 day
							9	In-B1/B2 External alarm	< 5 seconds

¹ This info code parameter does not appear from the current info code as it is only active when the meter is without supply. The info code is saved in the info log, and thus it will appear from the info log that the meter has been without power supply.

² Info code for leakage at pulse input B must be actively selected.

³ As the 4-wire signal inputs have a very high impedance, a disconnected wire may cause a random temperature, including that the info code shows "Above measuring range" (switched off) or "Below measuring range" (short-circuited).

⁴ Active after startup and at midnight.

Note: Info codes are configurable. Therefore, it is not certain that all parameters above are available in a given MULTICAL® 603. This depends on the selected country code.

Examples of information codes

**Flashing "INFO"**

If the information code is different from "00000000", a flashing "INFO" will appear in the meter's display.

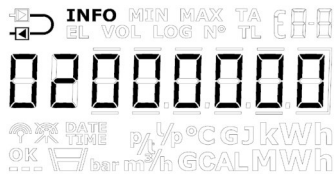
**Current information code**

The current info code can be displayed by scrolling to the info code reading using the keys on the calculator front. When the current info code is displayed, "INFO" stops flashing.

In the example, the current info code indicates that t1 is below the measuring range or short-circuited.

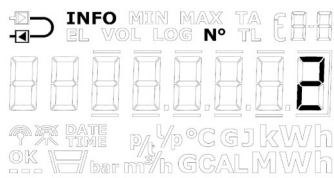
**Info event counter**

The info event counter is a secondary view for the info code, indicating how many times the info code has been changed.

The value is increased every time the info code is changed.

The info event counter of a new meter will be 0 as transport state prevents counting during

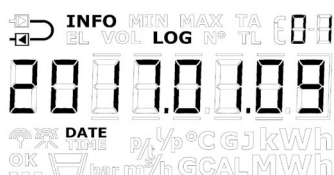
**Info logger**

The display reading states the date of the latest info code change.

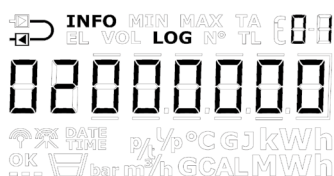

The display reading shows the info code from the previously displayed date. Repeated activations of the front keys alternately induce date and corresponding info code.

The data logger saves the last 250 changes, of which the last 50 can be shown on the display.

The entire info log (250 changes) can be viewed via LogView HCW.

Note: The info code is saved in the meter's data logger too for diagnostic purposes.

The info code types which are related to the meter's different sensors will in case of error influence the display readings, to which they are tied. In connection with current values for temperatures and power, three horizontal lines will appear in the display, and the energy registers, in which counting is dependent on the sensor function, will not be accumulated. See paragraphs 6 and 7.7 for further information on sensor errors.

MULTICAL® 603

Temperature sensor error

The error can be due to the sensor being disconnected or short-circuited. An erroneous $\Delta\theta$ alone will not be considered a temperature sensor error.

In case of an error in one or more temperature sensors (t1, t2 and t3), the value of the serial communication of the sensor in question will be 0,00 °C (lowest valid temperature) or 185,00 °C (highest valid temperature) respectively, depending on the measurement being below range (sensor short-circuited) or above range (sensor disconnected). The display reading of the sensor in question shows lines in the three digits to the far right in the display, independent of the cause of the error - decimal points are not included.

The display readings of $\Delta\theta$ and actual power will also show three lines for errors in one or more temperature sensors. In serial communication, the value will be 0,00 K and 0,0 kW.

Information codes in transport state

The meter leaves the factory in transport state, i.e. the info codes are active in the display, but not in the meter's data logger. This prevents the counting of info events and the saving of non-relevant data in the info log during transportation. The first time the meter registers flow after the installation, the info code automatically becomes active.

Update of info codes for flow

As shown in the table above, info codes from ULTRAFLOW® X4 are updated once a day. If you want to see the current info code status from ULTRAFLOW® X4, you can perform an update by switching to the display view with the current info code. This view is identified through a constantly lit "INFO" segment on the display. When you have switched to the view with the current info code, the info code from ULTRAFLOW® X4 is updated in the display every 10 seconds.

7.7.2 Information code types on serial communication

Bit	Value	Info
0	1	Supply voltage disconnected
1	2	Low battery level
2	4	External alarm (e.g. via KMP)
3	8	t1 Above measuring range or switched off
4	16	t2 Above measuring range or switched off
5	32	t1 Below measuring range or short-circuited
6	64	t2 Below measuring range or short-circuited
7	128	Wrong Δt (t1-t2)
8	256	V1 Air
9	512	V1 Wrong flow direction
10	1024	-
11	2048	V1 Increased flow (flow1 > qs, for more than 1 hour)
12	4096	In-A1 Leakage in the system
13	8192	In-B1, leakage in the system
14	16384	In-A1/A2 External alarm
15	32768	In-B1/B2 External alarm
16	65536	V1 Communication error
17	131072	V1 Wrong pulse figure
18	262144	In-A2 Leakage in the system
19	524288	In-B2 Leakage in the system
20	1048576	t3 Above measuring range or switched off
21	2097152	t3 Below measuring range or short-circuited
22	4194304	V2 Communication error
23	8388608	V2 Wrong pulse figure
24	16777216	V2 Air
25	33554432	V2 Wrong flow direction
26	67108864	-
27	134217728	V2 Increased flow (flow2 > qs, for more than 1 hour)
28	268435456	V1/V2 Burst, water loss (flow1 > flow2)
29	536870912	V1/V2 Burst, water penetration (flow1 < flow2)
30	1073741824	V1/V2 Leakage, water loss (M1 > M2)
31	2147483648	V1/V2 Leakage, water penetration (M1 < M2)

7.8 Transport state

Before MULTICAL® 603 for the first time has registered a flow of 1 % of q_p or larger, the meter is in transport state. The transport state includes that:

- No info codes are saved in the meter’s logger and the info event counter is not active.
- A power saving measuring sequence is used.
- The "SETUP loop" is available, which enables you to configure the meter before commissioning.

Note: In general, the "SETUP loop" is available, it can however be limited by the selected country code.

Be aware that the access to the "SETUP loop" will be blocked and the meter will leave transport mode if the configuration in the "SETUP loop" is ended by the function "EndSetup". When the meter has left transport state, info codes will be logged and the measuring sequence is changed to the one ordered for the meter (determined by the L-code). The meter cannot revert to transport state, unless a total reset is made. The access to the "SETUP loop" can, however, be opened again by separating calculator top and base. This means breaking the installation seal, see paragraph 4.6.

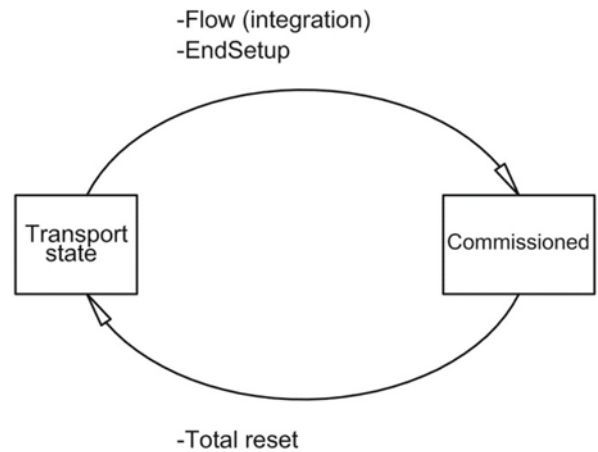

Radio communication

On delivery, the meter is in transport state and the meter’s radio communication is deactivated. The radio is activated when the meter for the first time has registered a flow of 1 % of q_p or larger. In transport state and after commissioning of the meter, the radio can be enabled either via the "SETUP loop" or by making a forced dial-up (both arrow keys are activated until "CALL" is displayed). Enabling the radio does not cause the meter to leave the transport state. Read more about deactivating radio communication in paragraph 6.3 about the "SETUP loop".

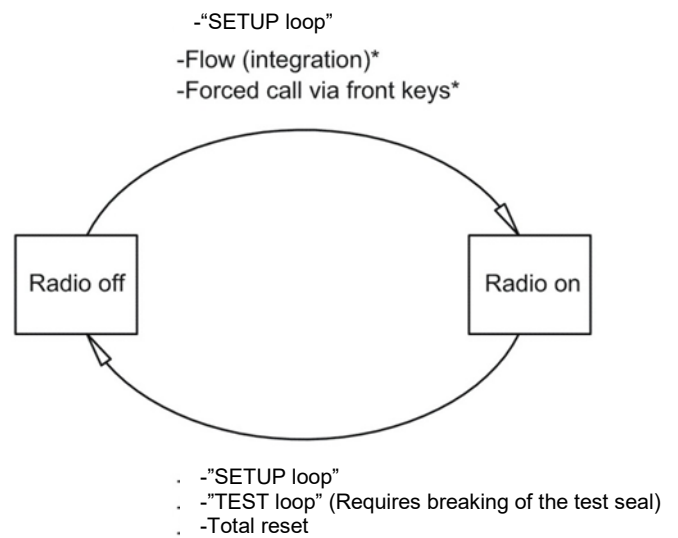

*If the meter is in "TEST loop" the radio remains off at flow (integration) and forced call

Test mode

When accessing the "TEST loop", radio communication is disabled. In the "TEST loop", flow will not activate the radio.

Note: In order to gain access to the "TEST loop", the test seal must be broken, and the meter must subsequently be re-verified.

7.9 Info logger

Every time the information code changes, the below-mentioned registers are logged.

Register type	Description
Date (20YY.MM.DD)	Year, month and day of logging time.
Clock (hh.mm.ss)	Time
Info	Information code on above date
E1	Heat energy
E3	Cooling energy

It is possible to data read the latest 250 changes of the information code as well as the dates the changes were made. When the information code is read from the display, 50 changes including dates can be read. All of the 250 changes can also be read by means of the PC program LogView HCW.

Infoevent

Every change of a parameter of the info code results in an info event if the selected country code is configured with the parameter. It is therefore not certain that all parameters result in an info event.

An info event results in accumulation of the info event counter as well as logging in the info logger. This does not apply as long as the meter is in transport state or if the calculator top and base are physically separated.

Reconfiguration of active parameters of the info code will influence future info codes, whereas all logged info codes remain as they were at the time of logging.

7.10 Config data logger

Every time the configuration is changed, the below-mentioned register types are logged. It is possible to data read the latest 50 changes of the config log as well as the dates the changes were made. The meter permits only 50 changes, unless you break the legal seal and carry out a total reset of the meter, which also resets the config log.

Note: The fiftieth change of configuration must be carried out on the installation site, i.e. either via the "SETUP loop" or via METERTOOL HCW.

Register type	Description
Date (20YY.MM.DD)	Year, month and day of change
Hour (hh.mm.ss)	Time
Configuration number	The new configuration number
E1, E3 and V1	Meter counts are saved just after reconfiguration
Hour counter	Hour counter is saved
t offset	The temperature offset value is saved.
V1 pulse figure	The pulse figure of V1 (imp/l or l/imp) is saved
V1 q_p	Nominal flow q_p is saved

The meter will always carry out a config logging if the user has had access to the "SETUP loop", no matter whether the user has changed the configuration or not.

7.11 Summer/winter time adjustment

MULTICAL® 603 is available with configuration for DST (Daylight Saving Time ~ summer/winter time). The meter's country code determines the DST-configuration algorithm, so that it corresponds to the DST regulations of the country, for which the meter is intended. If the meter is configured with DST and you do not want to use it, the DST-function can be disabled in the PC-program METERTOOL HCW. The DST-function has direct influence on the meter's internal clock and time-controlled tariff limits. Time stamps for loggings of events and values are saved in standard time together with information on the current DST offset. The current DST offset is applied to all logged time stamps when the DST function is active, the applied DST offset is removed from time stamps if the DST function is deactivated in the meter and vice versa if the DST function is reactivated.

DST and tariffs: The time-controlled tariff is influenced by the DST offset. The entered tariff limits, for example, will be moved an hour forward at DST start and an hour backwards at the end of DST (Danish example). If the DST function is disabled after a period in operation, the time limits will always follow standard time. Accumulated energy in the tariff registers remains unchanged and thus reflects the time limits with enabled DST-function. The same applies vice versa if the DST-function is reactivated.

DST and loggers: The logging time follows normal time. For example, a meter with enabled DST-function, which logs data at 00.00 during winter time, will log data at 01.00 a.m. during summer time (Danish example). If the DST-function is disabled after delivery and historical logger values are subsequently read, the DST offset of previous values will reflect the new configuration and be removed from the time stamp. See example in below table. Read logging times will always reflect the current DST status.

	DST enabled	DST disabled
Logs target date	Logging time	Logging time
1 January	00:00	00:00
1 February	00:00	00:00
1 March	00:00	00:00
1 April	01:00	00:00
1 May	01:00	00:00
1 June	01:00	00:00
1 July	01:00	00:00
1 August	01:00	00:00
1 September	01:00	00:00
1 October	01:00	00:00
1 November	00:00	00:00
1 December	00:00	00:00

DST and max/min. values: Time stamps on logging of max/min. values follow standard time. If the time stamp of a value is read, it will be stated with current DST offset. If the DST-function is disabled after delivery, the DST offset will be removed from the time stamps of historical values as it is done with the loggers.

DST and readout of logging data: Data can either be read from a register, which includes time in standard time and DST offset as two separate parameters, or alternatively from a register, which includes time comprising DST offset as a parameter. If the DST-function is disabled after delivery, information on the DST offset will be removed from time stamps related to the historical values.

7.12 Preset and Scheduler functions for temperature inputs

With MULTICAL® 603, it is possible to program (preset) values of the meter's temperature inputs. The primary need for programmed values is in the case when measuring hot water energy where the cold temperature is required to be programmed as it in practice cannot be measured. Read more about application examples in paragraph 7.1. In addition to programming a fixed value (preset), it is also possible to program a variable value that varies over the 12 months of a year (Scheduler). The table below shows which temperature inputs of which meter type can be programmed.

Note: The temperature inputs t1 and t2 are the two legal inputs, which means that they cannot be programmed on an approved heat meter, cooling meter or combined heat/cooling meter.

Meter type		Approvals	Temperature inputs			
			t1	t2	t3	t4
1	Heat meter	MID module B	-	-	☑	☑
2	Heat meter	MID module B+D	-	-	☑	☑
3	Heat/cooling meter	MID module B+D & TS 27.02 $\Theta_{HC} = OFF$	-	-	☑	☑
4	Heat meter	National approval	-	☑	☑	☑
5	Cooling meter	TS 27.02+BEK1178	-	-	☑	☑
6	Heat/cooling meter	MID module B+D & TS 27.02 $\Theta_{HC} = ON$	-	-	☑	☑
7	Volume meter	-	-	☑	☑	☑
9	Energy meter	-	-	☑	☑	☑

7.13 Differential energy and volume calculation

MULTICAL® 603 has integrated differential calculation of energy and volume. The result of these calculations are saved in the following four registers:

- dE: difference Energy ($E4 - E5 > 0$)
- cE: control Energy ($E4 - E5 < 0$)
- dV: difference Volume ($V1 - V2 > 0$)
- cV: control Volume ($V1 - V2 < 0$)

All four registers are accumulated registers where dE and dV count at a positive difference and cE and cV count at a negative difference. A reading of both the difference and the control registers reveals how much registers have been counted with a positive or negative difference over a given period, thus it is possible to get information about how stable the system has been throughout the selected period.

The calculations follow the selected integration mode, and the calculations are thus carried out at the selected integration interval. All four registers can be displayed in the meter's "USER loop" and are saved in the meter's loggers. See paragraph 3.2.4 about display setup (DDD-codes) and paragraph 3.2.10 about possible logger profiles (RR-codes).

Below is a calculation example of the dE and cE registers as well as examples of display readings.

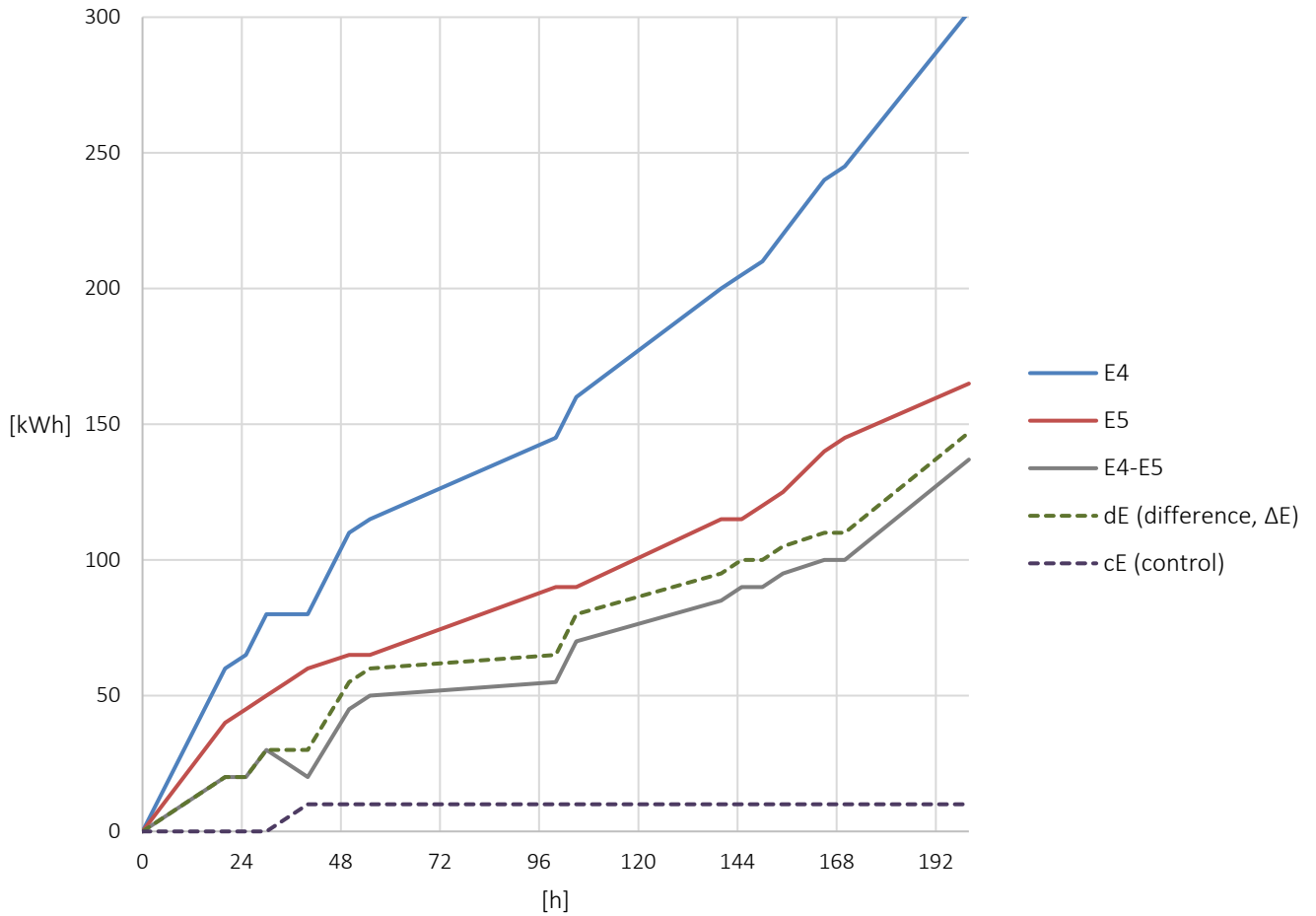

In a scenario where no counting is taking place in register E4 (energy fed), e.g. due to air in flow meter V1, the counting will take place in cE (control). This is shown in the above example between data items 24 and 48 [h].

Energy	
Difference energy <i>dE</i>	
Control energy <i>cE</i>	

Volume	
Difference volume <i>dV</i>	
Control volume <i>cV</i>	

8 Flow sensor connection

MULTICAL® 603 has up to 6 pulse inputs for connection of flow sensors where V1 and V2 are used for calculating energy, whereas In-A1, In-B1, In-A2 and In-B2 can be used for connecting, for example, cold water meters and electricity meters. The number of pulse inputs may vary according to meter configuration.

Pulse figure and resolution of the V1 and V2 inputs are configured via the CCC-code in MULTICAL® 603. If two flow sensors are used on V1 and V2, respectively, these two sensors must be identical as the pulse inputs share configuration. For an overview of CCC-codes, see paragraph 3.2.3.

Depending on application type, MULTICAL® 603 can be connected to one or two flow sensors for energy calculation purposes, see paragraph 7.1 for examples of application types. Typically, one flow sensor is used in heat or cooling installations, this flow sensor is always connected to V1, regardless if it is positioned in inlet or outlet.

Connection PCB with the possibility of V1 and V2 can receive pulses from both electronic and mechanical flow sensors. This enables connection of almost any type of flow sensor with pulse output. For flow sensors with 24 V active pulse output, see paragraph 8.4.

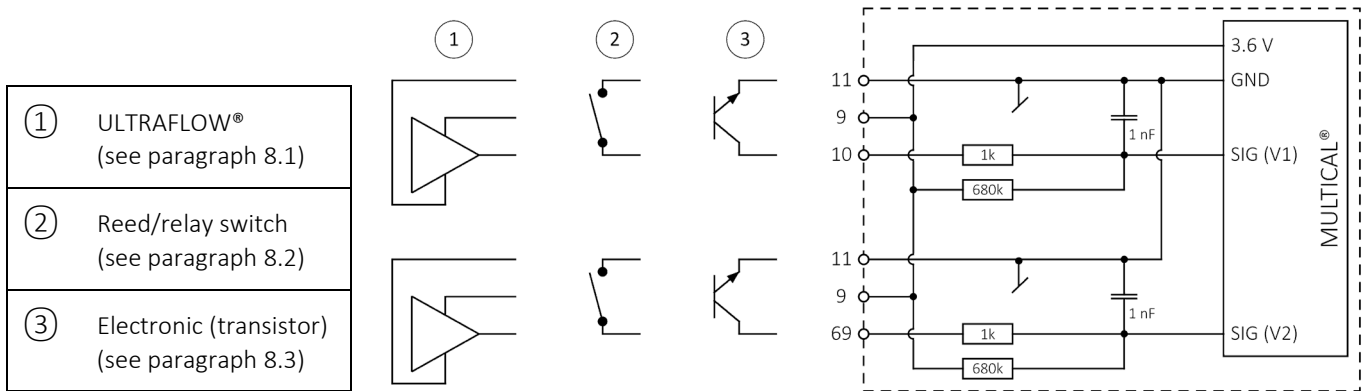

8.1 ULTRAFLOW® (Connection type 1-2-7-8)

Kamstrup's ULTRAFLOW® flow sensors are supplied from the calculator and connected according to the table below. The power consumption of ULTRAFLOW® is very low and, at the same time, matches the stated battery lifetimes of MULTICAL® 603, see paragraph 10.4.

Cable ULTRAFLOW®	Screw terminals V1	Screw terminals V2
Red (3,6 VDC)	9	9
Yellow (signal)	10	69
Blue (GND)	11	11

For ULTRAFLOW®, CCC-codes 1xx, 4xx and 5xx are used.

MULTICAL® 603

8.1.1 Auto Detect of ULTRAFLOW® X4

Auto Detect enables the exchange of ULTRAFLOW® X4 on MULTICAL® 603 without changing the CCC code.

MULTICAL® 603 can automatically adapt its CCC code to match the connected ULTRAFLOW® X4 via the function Auto Detect. Auto Detect is active with CCC code 8xx.

Auto Detect functions in such a way that MULTICAL® 603 during start up automatically retrieves the correct information about pulse figure and q_p from the connected ULTRAFLOW® X4 flow sensors. MULTICAL® 603 adapts its configuration to the values received from ULTRAFLOW® X4. Auto Detect is initiated when the calculator top and base are separated and reassembled.

8.1.1.1 Auto Detect with one ULTRAFLOW® X4 on V1

To use the Auto Detect functionality between MULTICAL® 603 and ULTRAFLOW® X4, follow the procedure below.

①		<p>Break the installation seal¹, and separate the calculator's top and base</p>
②		<p>Mount ULTRAFLOW® X4 on input V1 in MULTICAL® 603 as stated in the table in paragraph 8.1</p>
③		<p>Assemble the calculator's top and base</p>
④	<p><i>Typical display duration 5 s</i></p>	<p>Note the flashing display on MULTICAL® 603, indicating that a search for ULTRAFLOW® X4 is being performed</p>
⑤	<p><i>Display duration 5 s</i></p>	<p>Note the static display on MULTICAL® 603, indicating that ULTRAFLOW® X4 has been found and registered successfully²</p>
⑥		<p>MULTICAL® 603 automatically changes to the primary energy display in the "USER loop"</p>

¹ Remember to re-establish the installation seal after completed Auto Detect.

² A configuration logging is carried out each time MULTICAL® 603 registers a change to q_p of ULTRAFLOW® X4 on V1.

Note: Auto Detect is possible on all ULTRAFLOW® x4, however not on SVM-configured ULTRAFLOW® variants (ULTRAFLOW® SVM country codes 196, 199, 295 and 296).

8.1.1.2 Auto Detect with two ULTRAFLOW® X4 on V1 and V2

The procedure for Auto Detect with two ULTRAFLOW® X4 is identical to the table in paragraph 8.1.1.1, except for item ② where an identical ULTRAFLOW® X4 connected to input V2 is mounted.

ULTRAFLOW® X4, which is mounted on V1, will always be decisive for correct pulse figure and qp, also for an application in which two ULTRAFLOW® X4 are used. This means that changing ULTRAFLOW® X4 on V2 will not result in a configuration logging, but only cause an information code. The info code will be present until ULTRAFLOW® X4 on either input V1 or input V2 has been exchanged so that both ULTRAFLOW® X4 are identical. Changing ULTRAFLOW® X4 to another pulse figure or qp on input V1 always results in a configuration logging.





In applications with two ULTRAFLOW® X4, both ULTRAFLOW® X4 must be exchanged to the same type, i.e. identical pulse figures and qp.

If pulse figure and qp are not identical, this results in an info code, see the description in paragraph 8.1.1.4.

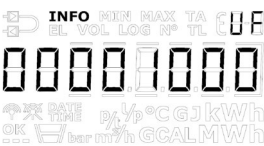

Note that Auto Detect with two ULTRAFLOW® X4 requires that the meter has been configured for two ULTRAFLOW® (Connection type 2 or 8) and at the same time that CCC = 8xx has been selected.

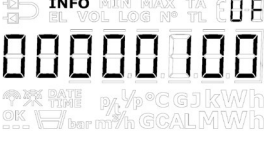
8.1.1.3 Auto Detect information codes

In case of incorrect ULTRAFLOW® or communication error with ULTRAFLOW® X4, MULTICAL® 603 shows a static info code, describing the occurred error (item ⑤ in the table in paragraph 8.1.1.1). The table below describes the possible info codes and their meaning.

Information code	Description	Remedy
 <p>Display duration 5 s</p>	Communication error on input V1.	Separate the calculator, and check that ULTRAFLOW® X4 has been mounted correctly in the screw terminals of input V1. Then, repeat the procedure in paragraph 8.1.1.1 from item ③.
 <p>Display duration 5 s</p>	Wrong pulse figure on input V1.	The config log is full. It is no longer possible to exchange ULTRAFLOW® X4 on input V1 with a size that differs from the latest logged size of V1.
 <p>Display duration 5 s</p>	Communication error on input V2.	Separate the calculator, and check that ULTRAFLOW® X4 has been mounted correctly in the screw terminals of input V2. Then, repeat the procedure in paragraph 8.1.1.1 from item ③.
 <p>Display duration 5 s</p>	Wrong pulse figure on input V2.	ULTRAFLOW® X4 on input V2 differs from ULTRAFLOW® X4 on input V1. Make sure that both ULTRAFLOW® X4 are identical, and repeat the procedure in paragraph 8.1.1.1.
 <p>Display duration 5 s</p>	Communication error on both input V1 and input V2.	Separate the calculator, and check that ULTRAFLOW® X4 has been mounted correctly in the screw terminals of input V1 and of input V2. Then, repeat the procedure in paragraph 8.1.1.1 from item ③.

MULTICAL® 603

Information code	Description	Remedy
 <p>Display duration 5 s</p>	Communication error on input V1 as well as wrong pulse figure on input V2.	Separate the calculator, and check that ULTRAFLOW® X4 has been mounted correctly in the screw terminals of input V1. Check that both ULTRAFLOW® X4 are identical. Then, repeat the procedure in paragraph 8.1.1.1 from item ③.
 <p>Display duration 5 s</p>	Wrong pulse figure on input V1 as well as communication error on input V2.	The config log is full. It is no longer possible to exchange ULTRAFLOW® X4 on either input V1 or input V2 with a size that differs from the latest logged size of V1. Separate the calculator, and check that ULTRAFLOW® X4 has been mounted correctly in the screw terminals of input V2. Check that both ULTRAFLOW® X4 are identical. Then, repeat the procedure in paragraph 8.1.1.1 from item ③.
 <p>Display duration 5 s</p>	Wrong pulse figure on both input V1 and input V2.	The config log is full. It is no longer possible to exchange ULTRAFLOW® X4 on either input V1 or input V2 with a size that differs from the latest logged size of V1.

8.1.2 The need for longer cables between MULTICAL® 603 and ULTRAFLOW®

In general, cables of up to 10 m between MULTICAL® and ULTRAFLOW® are allowed. In case longer cables are needed, Kamstrup can deliver two solutions, either Cable Extender Box (6699-036) or Pulse Transmitter (6699-903). With these solutions, the cable length can be extended up to 30 m or 100 m, respectively. Both solutions have a number of advantages and disadvantages, which are outlined in the table below.

Application options	Cable Extender Box	Pulse Transmitter
Up to 30 m cable between ULTRAFLOW® and MULTICAL®	Yes	Yes
Up to 100 m cable between ULTRAFLOW® and MULTICAL®	No	Yes
Info codes and data communication between ULTRAFLOW® and MULTICAL®	Yes	No
Galvanic separation between ULTRAFLOW® and MULTICAL®	No	Yes
IP class	IP 65	IP 67

When Pulse Transmitter is used between ULTRAFLOW® and MULTICAL®, the calculator will not be able to establish data communication with ULTRAFLOW® due to the galvanic separation. To avoid faulty info codes, it is thus necessary to deselect the info codes based on data communication between MULTICAL® and ULTRAFLOW® (Info = 16-1024-2048-128-4096-8192-16384-32768).

The above info codes can be deselected by means of the PC program METERTOOL HCW by changing, for example, from CCC-code 4xx to 1xx.

8.2 Flow sensor with reed or relay switch output (Connection type L)

The reed switch output is typically placed as a pick-up unit on vane wheel or Woltmann meters where the relay switch output is typically found on magnetic inductive flow sensors. Flow sensors connected to input V1 on the screw terminals 10 (+) and 11 (-) and input V2 on the screw terminals 10 (+) and 69 (-). Screw terminal 9 is not used in this application.

The leakage current in the switch must not exceed 1 μA in OFF state, and the resistance in the switch set must not exceed 10 k Ω in ON state.

It must be ensured that MULTICAL® 603 is configured with a CCC-code whose pulse figure (imp./l or l/imp.) matches the connected flow sensors.

Example: CCC = 011 is used for a meter with reed pulses with 10 l/imp. and a max flow of 1...30 m³/h.

8.3 Flow sensor with transistor output (Connection type 7-8-C-J)

Typically, the flow sensor output is constructed as an opto coupler with BJT or FET transistor output. Flow sensors connected to input V1 on the screw terminals 10 (+) and 11 (-) and input V2 on the screw terminals 10 (+) and 69 (-). Screw terminal 9 is not used in this application.

The leakage current in the transistor must not exceed 1 μA in OFF state, and the voltage above the transistor must not exceed 0,4 V in ON state.

It must be ensured that MULTICAL® 603 is configured with a CCC-code whose pulse figure (imp./l or l/imp.) matches the connected flow sensors.

Example: CCC = 201 is used for an electronic meter with 1 l/imp. and $q_p = 4...150$ m³/h.

8.4 Flow sensors with active 24 V pulse output (Connection type P)

Flow sensors with active 24 V pulse output from for example Siemens, Krohne or ABB can be directly connected to MULTICAL® 603 type 603-G. At the same time, this type is prepared for connection of 4-wire temperature sensors. The flow sensor connection is carried out as shown in the figure below. For further examples, see 8.4.1.

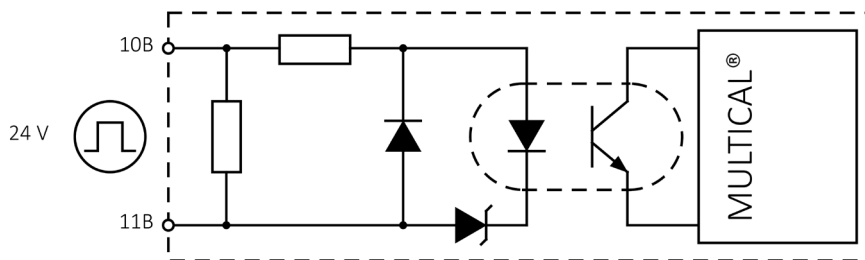

Technical data:

Pulse input voltage	12...32 V
Pulse current	Max 12 mA at 24 V
Pulse frequency	Max 128 Hz
Pulse duration	Min. 3 ms
Cable length V1	Max 100 m
	(Drawn with min. 25 cm distance to other cables)

MULTICAL® 603

Galvanic separation	Input V1 is galvanically separated from MULTICAL® 603
Insulation voltage	2 kV
Mains supply for MULTICAL®	24 VAC/VDC or 230 VAC
Battery lifetime (D-cell) of MULTICAL® including 1 standard module (e.g. WM-Bus)	Using 24 V active pulses on V1: 14 years

8.4.1 Connection examples

Flow sensor with NPN transistor output and internal 24 VDC supply

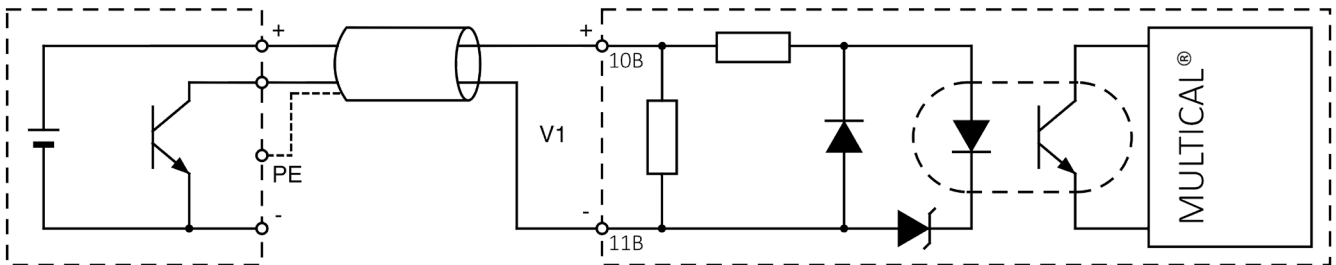

Flow sensor with PNP transistor output and internal 24 VDC supply

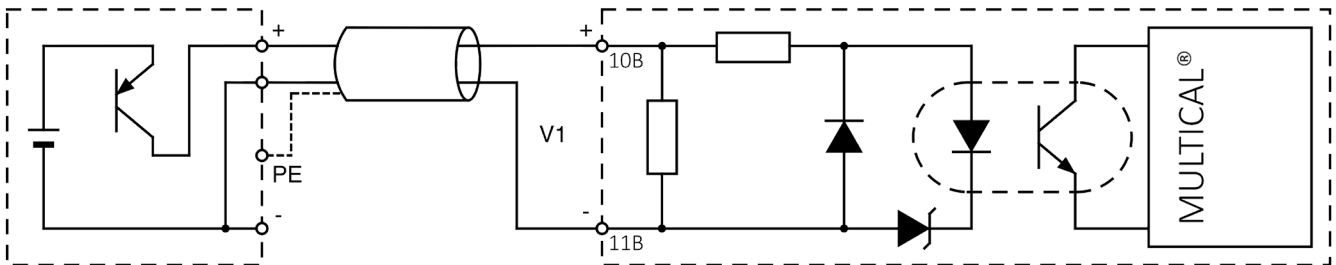

Flow sensor with transistor output and external 24 VDC supply

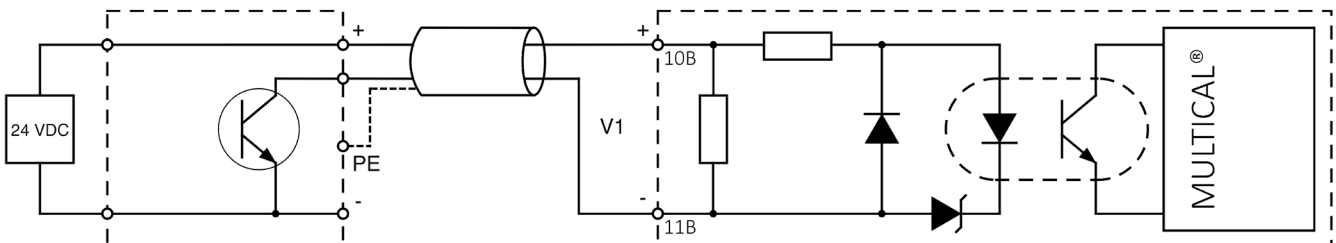

8.5 MULTICAL® with V1 and V2 of different sizes

The MULTICAL® generation 3 only has one CCC-code shared by flow sensors V1 and V2 and thus only the possibility to utilize two ULTRAFLOW® with the same meter factor (p/l) and the same nominal flow (qp).

When utilizing MULTICAL® connected to two ULTRAFLOW® V1 and V2 in relation to open systems it may be beneficial to utilize an ULTRAFLOW®-V2 with a lower nominal flow (qp) than the nominal flow (qp) for the utilized ULTRAFLOW®-V1 e.g. in application 7, see paragraph 7.1.3.

It is possible to utilize a V2 smaller than V1 by including a Pulse Divider for V2 to scale down the meter factor of the ULTRAFLOW®-V2 to match the meter factor of the ULTRAFLOW®-V1 see *Table 5*. The MULTICAL® is ordered separately* with a CCC-code to fit The ULTRAFLOW®-V1. The ULTRAFLOW® for both V1 and V2 and the corresponding Pulse Divider are ordered separately.

Note: The nominal flow (qp) of ULTRAFLOW®-V2 must be lower than the nominal flow (qp) of ULTRAFLOW®-V1 when utilizing this method.

Flow sensor V2 \ Flow sensor V1	qp = 0,6 m³/h (300 p/l)	qp = 1,5 m³/h (100 p/l)	Qp = 2,5 m³/h (60 p/l)	qp = 3,5 m³/h (50 p/l)
qp = 2,5 m³/h (60 p/l)	Divisor 5 (116-41-1)	N/A	N/A	N/A
qp = 3,5 m³/h (50 p/l)	Divisor 6 (116-51-1)	Divisor 2 (119-51-1)	N/A	N/A
qp = 6,0 m³/h (25 p/l)	Divisor 12 (116-12-1)	Divisor 4 (119-12-1)	N/A	Divisor 2 (151-12-1)
qp = 10 m³/h (15 p/l)	N/A	N/A	Divisor 4 (198-22-1)	N/A
qp = 15 m³/h (10 p/l)	N/A	Divisor 10 (119-32-1)	Divisor 6 (198-32-1)	Divisor 5 (151-32-1)

Table 5 - Divisor based on the size difference between V1 and V2 – V1 must be larger than V2. The number in bracket for each possible divisor is the CCC-DD-E configuration of the Pulse Divider for V2

* The MULTICAL® is ordered prepared for flow sensors with fast electronic pulses (Flow sensor connection type C), and the corresponding 1xx CCC-code to match the meter factor (p/l) of the chosen ULTRAFLOW®-V1.

MULTICAL® 603

8.5.1 Connection of flow sensor with own supply voltage

The pulse output from a flow sensor with own supply voltage must always be connected to an opto-isolated pulse input on the calculator. This provides a noise-resistant and reliable connection. The special opto-isolated input circuit of MULTICAL® 603-G further enables the connection of long cables between flow sensor and calculator (up to 100 m cable).

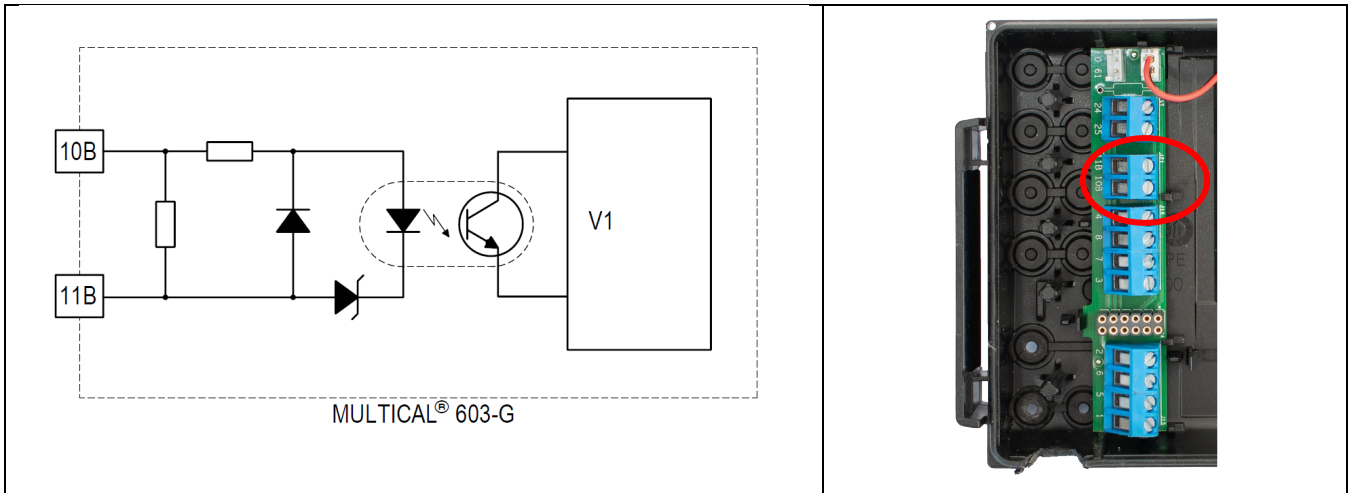
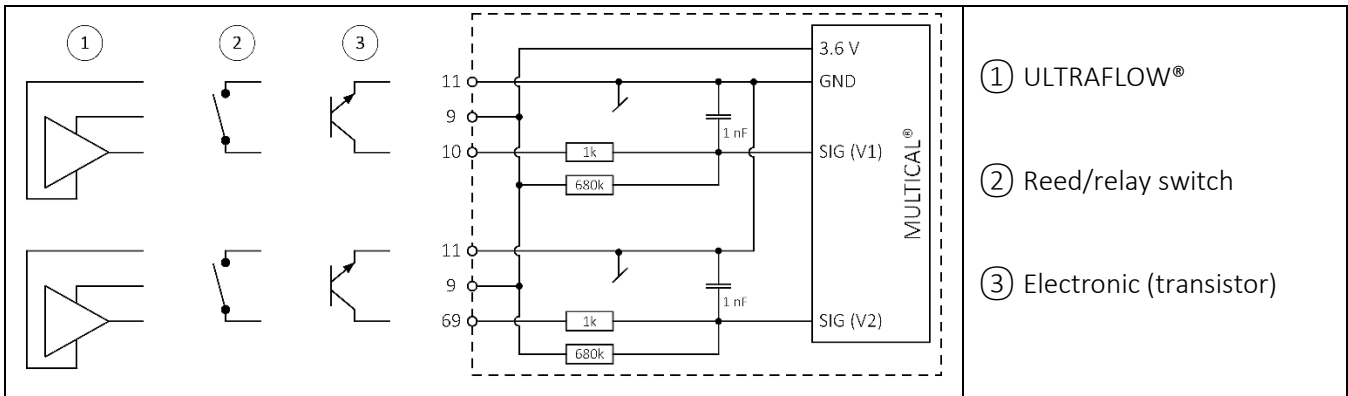

Figure 7 Opto-isolated pulse input (V1) on MULTICAL® 603-G (PCB 5550-1550).

Note that Auto Detect and extended info codes for flow sensor only work with ULTRAFLOW®. See also paragraph 7.8.

The passive pulse output from a flow sensor with own supply voltage must not be connected directly to pulse input V1 (terminals 11-9-10) and V2 (terminals 11-9-69) on MULTICAL®.

Only flow sensors of the 3 types ①-②-③ below may be connected directly to these pulse inputs.



8.5.1.1 Kamstrup ULTRAFLOW® with Pulse Transmitter

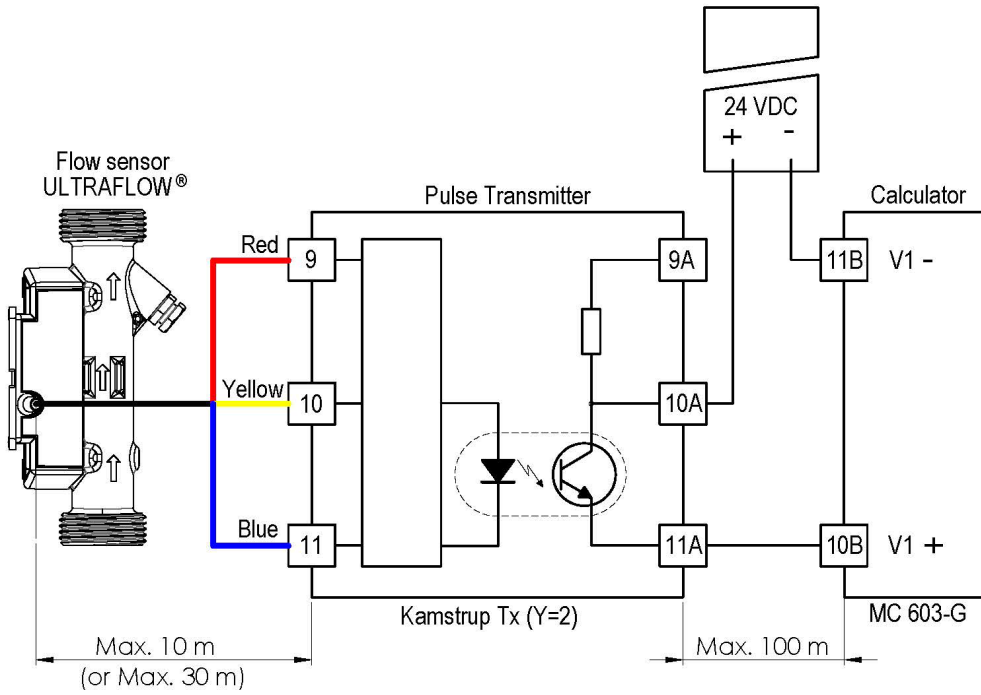

8.5.1.2 MAG5000 with 24 V active pulse output

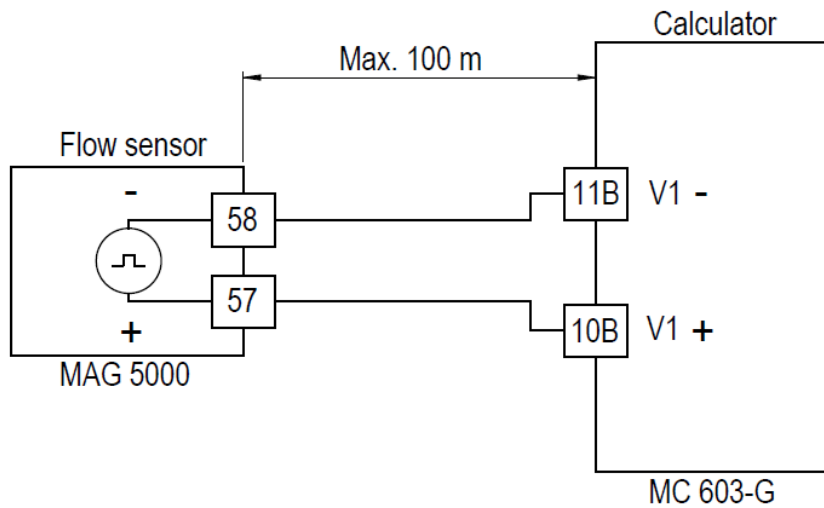

MULTICAL® 603

8.5.1.3 MAG8000/FUE/FUS with passive pulse output

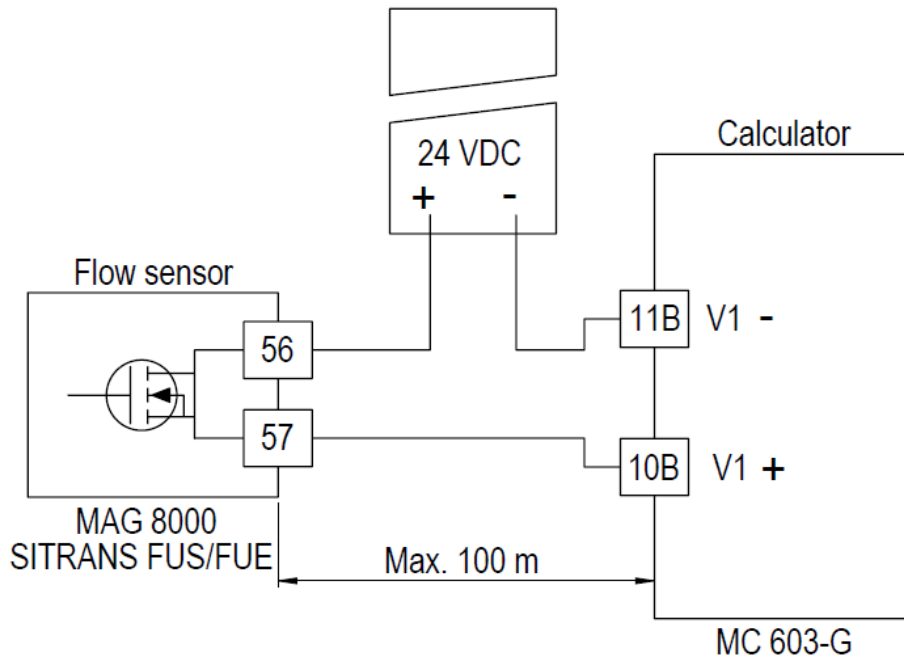

8.5.1.4 Krohne flow sensor with passive pulse output

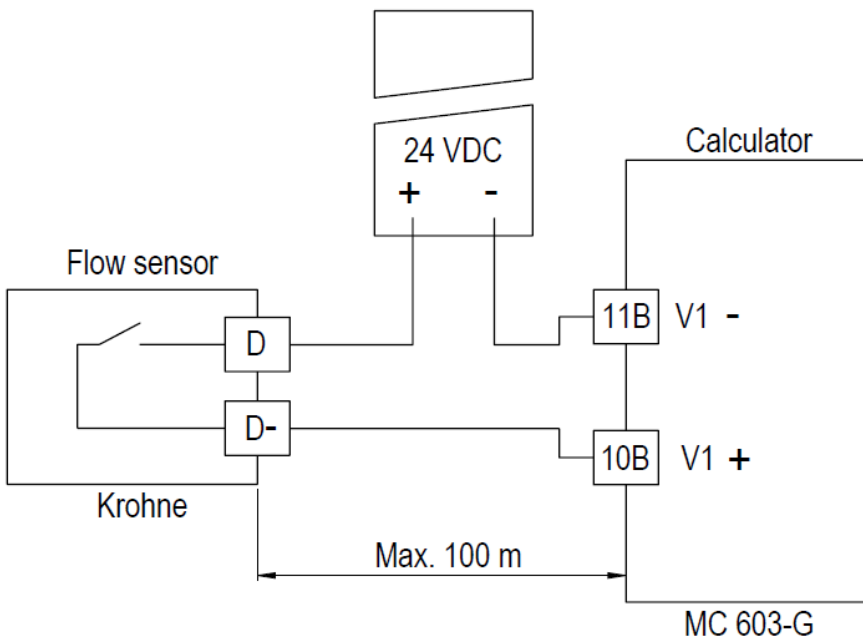

8.6 Connect more calculators to one flow sensor

In installations with 2 or more consumers in “serial connection”, it can be advantageous to use the signal from one flow sensor for more calculators, like for example shown in the setup below.

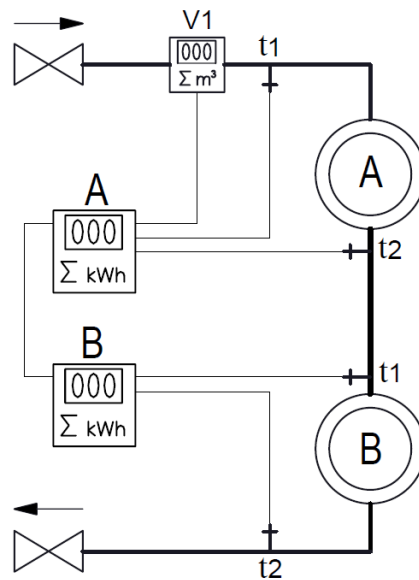
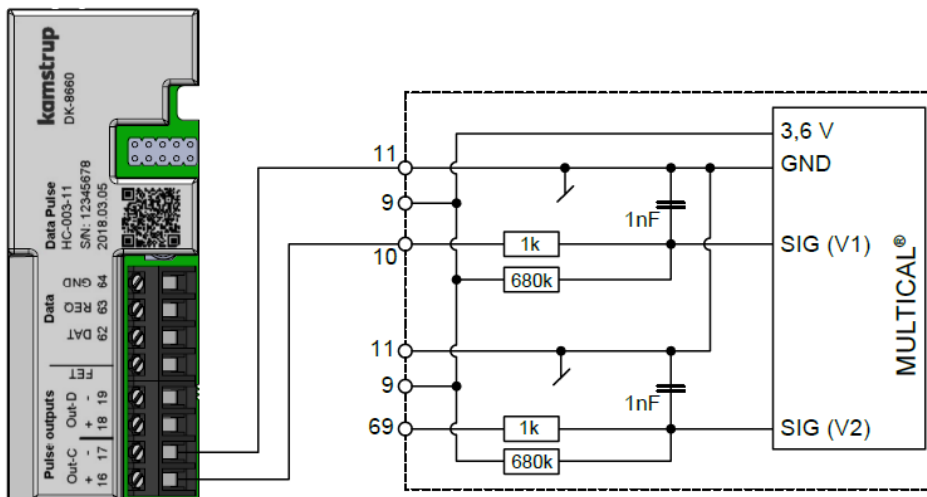

Figure 8 Heat installation with one flow sensor and 2 calculators.

When a module with pulse outputs is connected and the Pp-code is set to PP = 82 pulses on the flow sensor, input V1 will be repeated on “Out-C” on the terminals 16 and 17. Remember to select the flow sensor connection type C and the correct CCC-code on the following calculator.



As the pulse output “Out-C” is galvanically separated, a short circuit or other fault will not damage the meter in front of it.

MULTICAL® 603

Pulse outputs C and D	PP-code
Pulse transmitter/divider	
Out-C: V1/4 (5 ms)	73
Out-C: V1/1, Out-D: V2/1 (3,9 ms)	80
Out-C: V1/1 (3,9 ms)	82
Out-C: V1/4 (22 ms)	83
Meter count registers	
10 ms	94
32 ms	95
100 ms (0,1 s)	96
Output controlled by data commands	
Controlled output	99

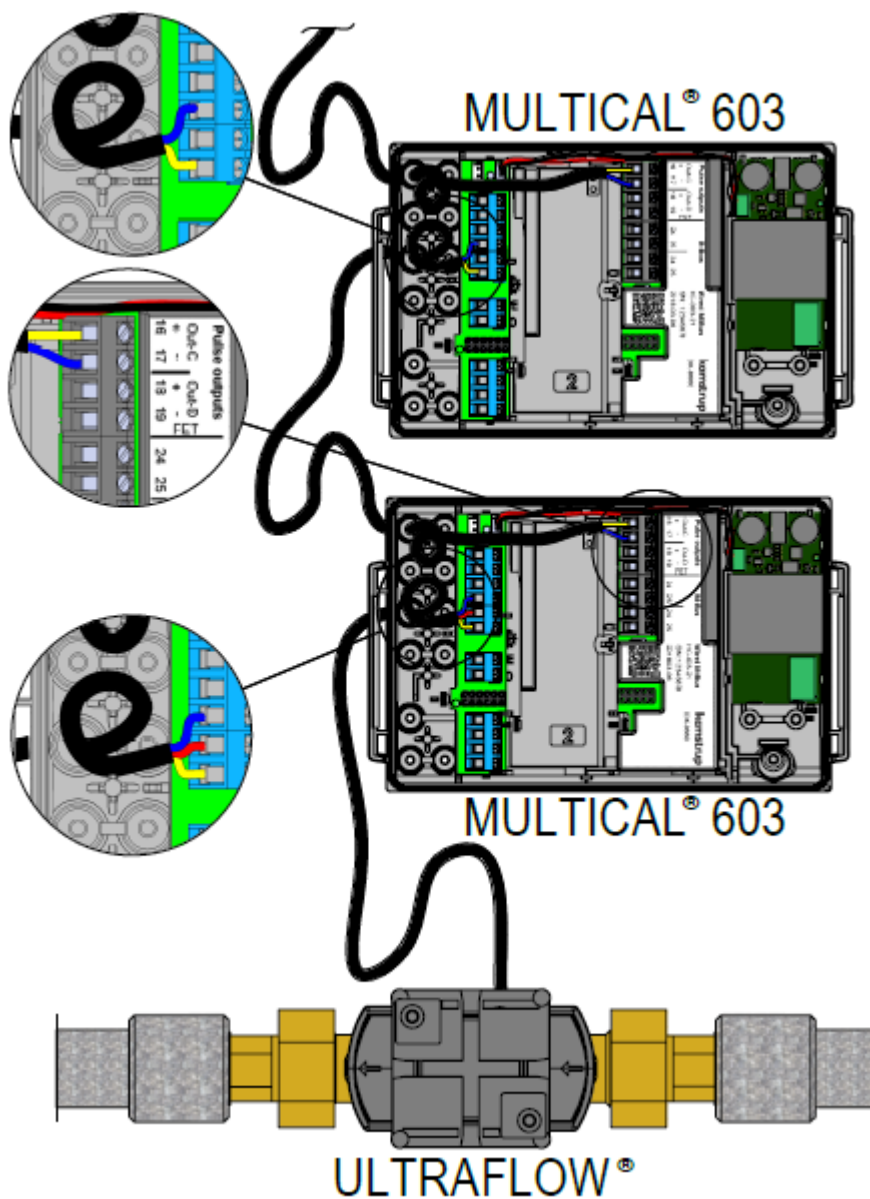

9 Temperature sensors

A platinum resistance thermometer utilises that the precious metal platinum has a very well-defined correlation between its resistance and the temperature. The correlation between the resistance and the temperature is defined in the standard EN 60751 (DIN/IEC 751) and tables showing examples of the correlation appear from paragraph 9.9. On MULTICAL® 603, Pt100 and Pt500 temperature sensors can be used for which the nominal resistance at 0 °C is 100 Ω and 500 Ω, respectively.

The correlation between the resistance R_t and the temperature t is defined as:

$$R_t = R_0(1 + At + Bt^2)$$

where R_0 indicates the resistance at 0.00 °C, whereas A and B are constants. The values R_0 , A and B are determined at the verification of temperature sensor, which is carried out according to EN1434-5.

On a heat or cooling meter, a temperature sensor set is used for measuring the temperature difference between inlet and outlet. As each of the two temperature sensors has its own values for R_0 , A and B , the requirement for an approved temperature sensor is, according to EN1434-1, that the maximum allowed difference in percent between the two temperature sensors, E_t , in the entire approval area is:

$$E_t = \pm \left(0,5 + 3 \frac{\Delta\theta_{min}}{\Delta\theta} \right)$$

where $\Delta\theta$ is the concrete temperature difference and $\Delta\theta_{min}$ is the minimum allowed temperature difference, typically 3 K. The values R_0 , A and B , of the separate temperature sensors as well as E_t appear from the certificate of the temperature sensor set.

9.1 Cable influence and connection of cables

Mostly, only relatively short cable lengths for temperature sensors are needed for small and medium-size heat meters, which means that 2-wire sensor sets can be used with advantage.

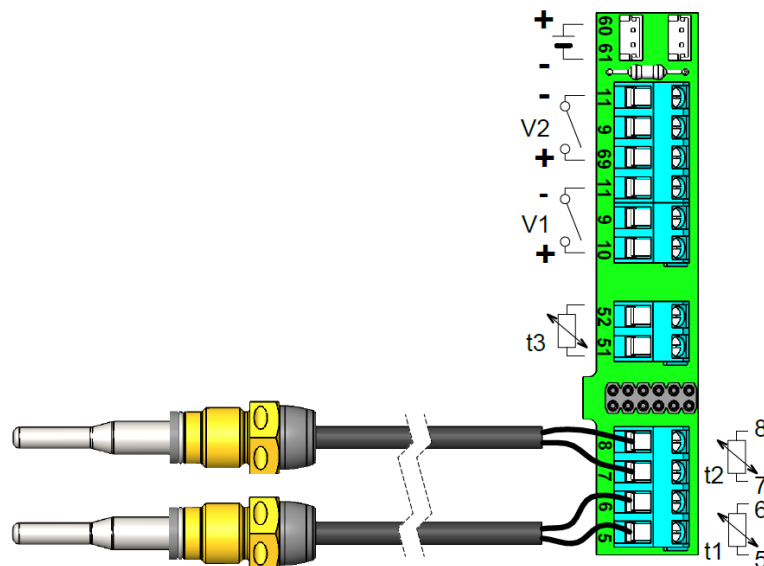

Cable lengths and cross sections of the two sensors which are used as temperature sensor pair for a heat meter must always be identical, and cable sensors must neither be shortened nor extended.

MULTICAL® 603

The limitations connected to the use of 2-wire sensor pairs according to EN 1434-2 appear from the table below.

Cable cross section [mm ²]	Pt100 sensors		Pt500 sensors	
	Max cable length [m] Subject to EN 1434-2	Temperature increase [K/m] Copper @ 20°C	Max cable length [m] Subject to EN 1434-2	Temperature increase [K/m] Copper @ 20°C
0,25	2,5	0,450	12,5	0,090
0,50	5,0	0,200	25,0	0,040
0,75	7,5	0,133	37,5	0,027
1,50	15,0	0,067	75,0	0,013

Table 6

4-wire sensor set

For installations requiring longer cable lengths than stated in the table above, it is recommended to use 4-wire sensor sets as well as MULTICAL® 603 type 603-B/D/G with 4-wire connection.

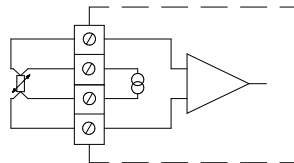

The 4-wire construction uses two conductors for the measuring current and two other conductors for the measuring signal, which means that the construction in theory is uninfluenced by long sensor cables. In practice, cables ought not to be longer than 100 m, and it is recommended to use 4 x 0,25 mm².

The connection cable ought to have an outer diameter of 5-6 mm in order to obtain optimum tightness of both MULTICAL® 603 and the screw-joint for the 4-wire sensor. The isolation material/cover of the cable ought to be selected on the basis of the maximum temperature in the installation. PVC cables are normally used up to 80°C, and for higher temperatures silicone cables are often used.

Note. When presetting temperatures on 4-wire meters, it is important to insert jumpers in the terminals on the 4-wire sensor inputs that have preset (for example jumper between the terminals 4-8 and jumper between the terminals 7-3 when presetting t2).

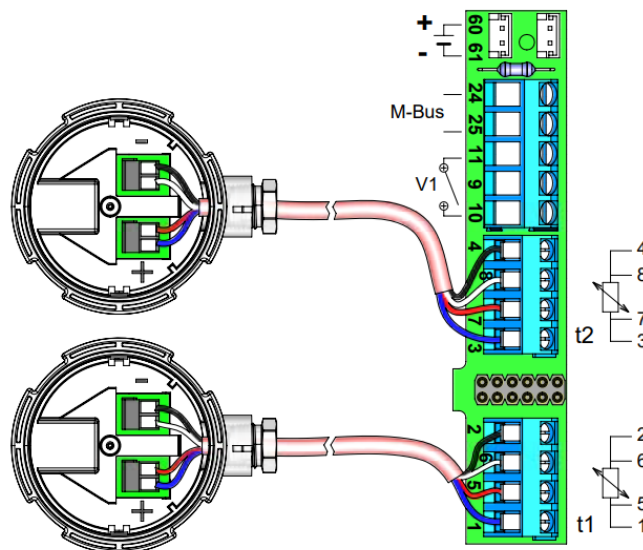

9.2 Sensor types

MULTICAL® 603 can be delivered with both Pt100 and Pt500 sensor pairs. The required sensor pair is selected through the meter's type number. The table below shows the available sensor pairs. See the meter's complete type number in paragraph 3.1.

For old sensor types, see document "Conversion to TemperatureSensor 63 & 83" (55122999_EN) at:

www.kamstrup.com/en-en/product-centre

<u>Description</u>	<u>Pt100/Pt500</u>	<u>Sensor number</u>
2 pairs Short direct 27,5 mm, 1,5 m cable	Pt500	51
2 pairs Short direct 27,5 mm, 3 m cable	Pt500	52
3 pairs Short direct 27,5 mm, 1,5 m cable	Pt500	55
3 pairs Short direct 27,5 mm, 3 m cable	Pt500	56
2 pairs Direct ø5,0 mm, 1,5 m cable	Pt500	61
2 pairs Direct ø5,0 mm, 3 m cable	Pt500	62
2 pairs Short direct 27,5 mm, 2 m cable	Pt100	J6
2 pairs Short direct 38 mm, 1,5 m cable	Pt500	21
2 pairs Short direct 38 mm, 3 m cable	Pt500	22
2 pairs ø5,2 mm direct temperature sensor, 1,5 m cable	Pt500	71
2 pairs ø5,2 mm direct temperature sensor, 3 m cable	Pt500	72
2 pairs ø5,2 mm direct temperature sensor, 5 m cable	Pt500	73
2 pairs ø5,8 mm pocket sensor, 1,5 m cable	Pt500	81
2 pairs ø5,8 mm pocket sensor, 3 m cable	Pt500	82
2 pairs ø5,8 mm pocket sensor, 5 m cable	Pt500	83
2 pairs ø5,8 mm pocket sensor, 10 m cable	Pt500	84
3 pairs ø5,8 mm pocket sensor, 1,5 m cable	Pt500	85
3 pairs ø5,8 mm pocket sensor, 3 m cable	Pt500	86
3 pairs ø5,8 mm pocket sensor, 5 m cable	Pt500	87
3 pairs ø5,8 mm pocket sensor, 10 m cable	Pt500	88
2 pairs ø6,0 mm pocket sensor, 1,5 m cable	Pt500	91
2 pairs ø6,0 mm pocket sensor, 3 m cable	Pt500	92
2 pairs ø6,0 mm pocket sensor, 5 m cable	Pt500	93
2 pairs ø6,0 mm pocket sensor, 10 m cable	Pt500	94
2 pairs ø6 mm with connection head, length 105 mm	Pt100	A1
2 pairs ø6 mm with connection head, length 140 mm	Pt100	A2
2 pairs ø6 mm with connection head, length 230 mm	Pt100	A3
2 pairs ø6 mm with connection head, length 105 mm	Pt500	A4
2 pairs ø6 mm with connection head, length 140 mm	Pt500	A5
2 pairs ø6 mm with connection head, length 230 mm	Pt500	A6
2 pairs ø5,8 mm pocket sensor in pocket with connection head, length 65 mm	Pt500	C1
2 pairs ø5,8 mm pocket sensor in pocket with connection head, length 90 mm	Pt500	C2
2 pairs ø5,8 mm pocket sensor in pocket with connection head, length 140 mm	Pt500	C3
2 pairs ø5,8 mm pocket sensor in pocket with connection head, length 180 mm	Pt500	C4

9.3 Pt500 direct short temperature sensor set

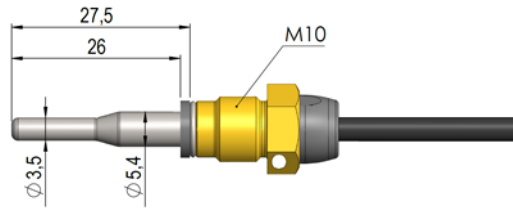

TemperatureSensor 63 direct short DS 27.5 mm temperature sensor has been designed according to the European standard for heat energy meters EN 1434-2. The temperature sensor is designed for direct mounting in the measured medium, i.e. without sensor pocket, by which a particularly fast response to temperature changes in, for example, utility water exchangers is obtained. The temperature sensor tube has a diameter of $\varnothing 3.5$ mm, is made of stainless steel and the temperature sensor element itself is placed in the tube. The temperature sensor is approved for both PN16 and PN25 installations, with PS25 as the maximum pressure. The temperature sensor is based on a 2-wire silicone cable and can thus be used with media temperatures up to 150 °C. One of the temperature sensors can be mounted in the flow sensor on delivery (see the technical description of ULTRAFLOW® 54/44 for information) and therefore, only the other temperature sensor must be mounted in the installation. As shown in *Figure 9* and *Figure 10*, this can, for example, be made with a nipple or a ball valve.

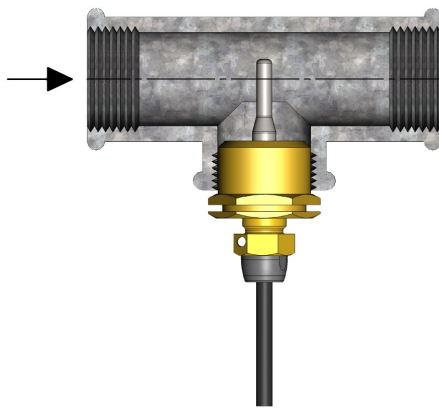

Figure 9

As it appears from *Figure 9*, the direct short temperature sensor DS 27,5 mm can be mounted by means of an R $\frac{1}{2}$ or R $\frac{3}{4}$ for M10 nipple in a standard 90° tee.

The direct short temperature sensor is also available in a 38 mm version, called DS 38 mm. Further information about this can be found in the TemperatureSensor SP data sheet. The application possibilities of the DS 27.5 mm and DS 38 mm temperature sensors are shown in *Table 7*.

DN	DS 27,5 mm	DS 38 mm
15	X	
20	X	
25	X	
32		X
40		X

Table 7: Application possibilities of the DS 27.5 mm and DS 38 mm two temperature sensors.

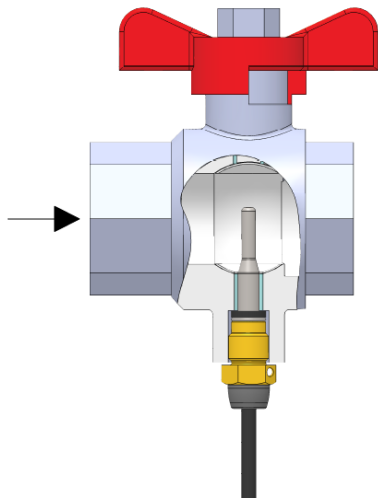

Figure 10

To obtain the best possible serviceability during meter replacement, the direct short temperature sensor can be placed in a ball valve with sensor socket, see Figure 10.

Ball valves with sensor sockets are available in G½, G¾, G1, all of which fit the DS 27.5 mm sensor as well as in G1¼ and G1½, both fitting the DS 38 mm sensor.

No.	6556-570	6556-571	6556-572
	G½	G¾	G1

No.	6556-526	6556-527
	G1¼	G1½

9.4 Pt500 \varnothing 5.0 mm / \varnothing 5.2 mm temperature sensors

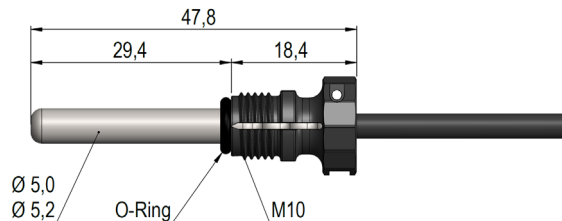

It applies to both the \varnothing 5.0 mm and \varnothing 5.2 mm temperature sensors belonging to TemperatureSensor 63 that they are delivered with attached composite union nuts which is why they, as a rule, must be used as direct temperature sensors. The temperature sensors are made of stainless steel and have a diameter of \varnothing 5.0 mm or \varnothing 5.2 mm. The temperature sensors are approved for both PN16 and PN25 installations, with PS25 as the maximum pressure. The temperature sensors are based on a 2-wire silicone cable and can thus be used with media temperatures up to 150 °C. This also applies to the composite union nut that is made of the material PPS. Asymmetric sensor installation (one temperature sensor installed as a direct temperature sensor and one as a pocket sensor) must only be used if national regulations allow this and never in installations with low differential temperature and/or low water flow.

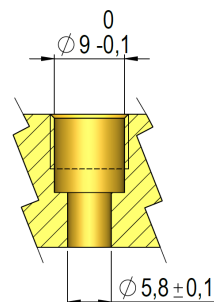
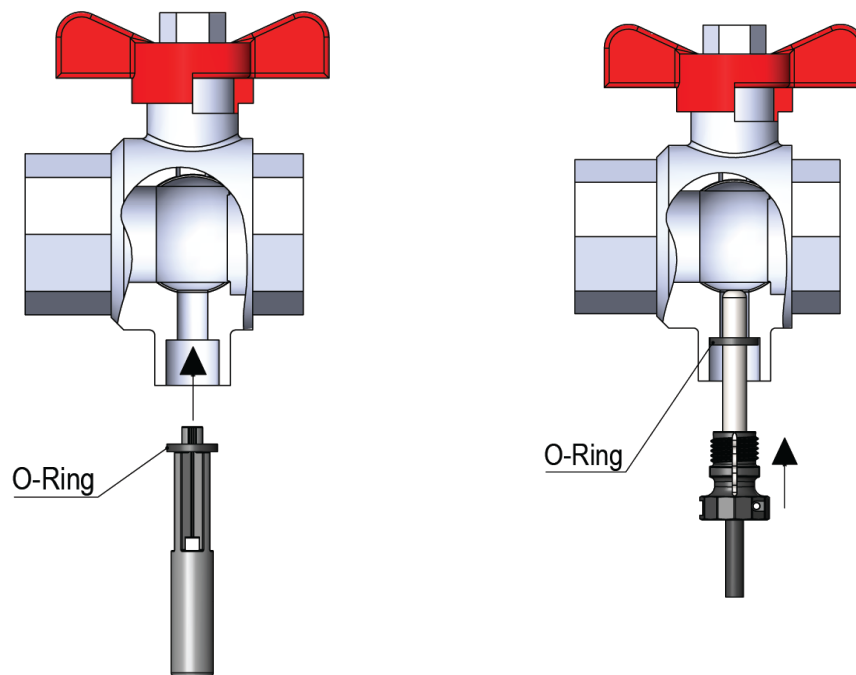
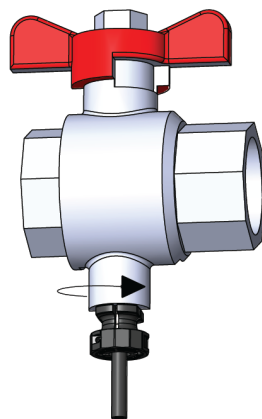

Figure 11: Measurement and tolerance requirements when installing a direct \varnothing 5.0 mm or \varnothing 5.2 mm temperature sensor.

Regardless of where the direct \varnothing 5.0 mm or \varnothing 5.2 mm temperature sensor is installed, it is very important that the processing complies with the tolerances shown in Figure Y. If not, the O-ring may not provide correct sealing. To avoid damage of the O-ring at the installation, it is important to use the guidance below when installing the \varnothing 5.0 mm or \varnothing 5.2 mm temperature sensor as a direct temperature sensor.



The O-ring guidance is used for pushing the O-ring into place after which the temperature sensor can be pushed to the bottom.



Fasten the plastic coupling manually. No tools must be used.

9.5 Pt500 \varnothing 5.8 mm / \varnothing 6.0 mm pocket sensor set

TemperatureSensor 63 \varnothing 5.8 mm / \varnothing 6.0 mm pocket sensor is a Pt500 wire sensor, designed with a 2-wire silicone cable and completed with a \varnothing 5.8 mm or \varnothing 6,0 mm shrinkable stainless steel sleeve that protects the sensor element. The steel sleeve is mounted in a sensor pocket (dip pipe). The sensor pockets for the \varnothing 5.8 mm temperature sensor are delivered with $R\frac{1}{2}$ (conic $\frac{1}{2}$ "") connection in stainless steel in the lengths 65, 90 and 140 mm. For the \varnothing 6.0 mm temperature sensor, the sensor pockets are supplied with $G\frac{1}{2}$ (straight $\frac{1}{2}$ "") connection, also in stainless steel, and can be delivered in the lengths 65, 85, 120 and 210 mm. For the \varnothing 6.0 mm temperature sensor, which is designed according to EN1434-2, it is particular that this temperature sensor, in the EU, may be used in all approved pockets for \varnothing 6 mm temperature sensors that are also designed according to EN1434-2, regardless of the manufacturer. The relevant pockets for \varnothing 6 mm temperature sensors are characterised by being marked with "EN1434". The sensor design with separate dip pipe enables exchange of sensors without first shutting off the water supply. In addition, the wide selection of dip pipe lengths ensures that the sensors can be mounted in all common pipe dimensions. The stainless steel pockets can be used for mounting in both PN16 and PN25 installations. At flow rates above 3 m/s or in a PN40 installation, it is recommended to use a reinforced stainless steel pocket with a diameter of \varnothing 10 mm at the tip and that is made of one piece.

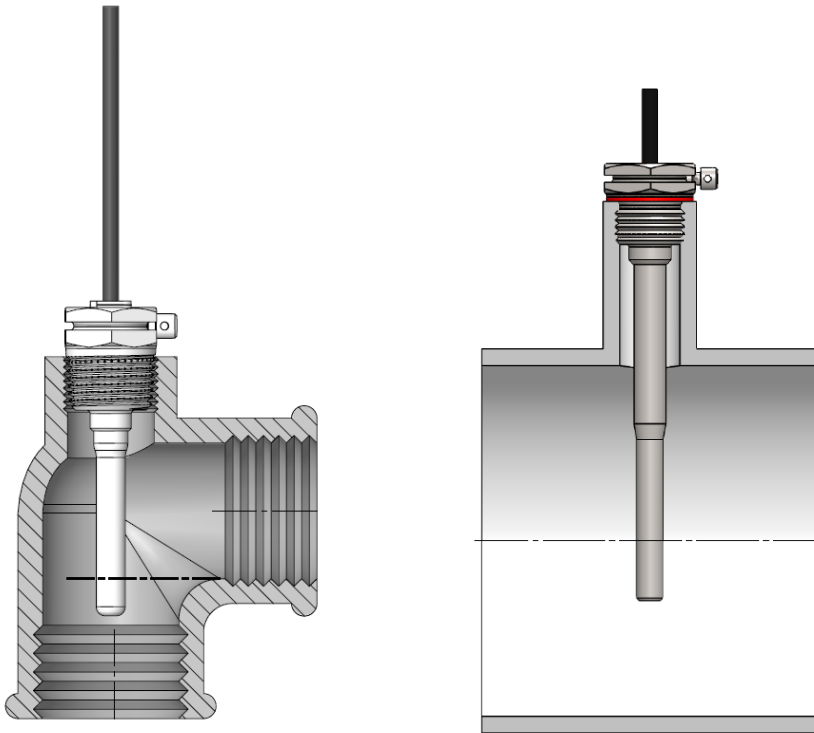
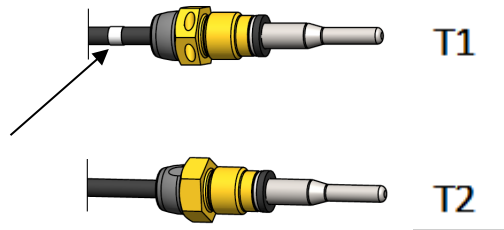
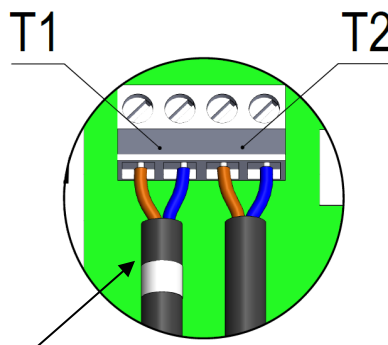

Figure 12: Examples of installation of sensor pocket for \varnothing 5.8 mm temperature sensor with $R\frac{1}{2}$ thread (to the left) and sensor pocket for \varnothing 6.0 mm temperature sensor with $G\frac{1}{2}$ thread and copper gasket (to the right).

9.6 Identification of inlet and outlet temperature sensor



To make it easier to carry out a correct installation of TemperatureSensor 63, the inlet temperature sensor is equipped with additional two white markings on the cable by which you can easily identify which of the two temperature sensors is the inlet temperature sensor or outlet temperature sensor, respectively. One of the white markings is placed right after the temperature sensor itself, see the figure above, which makes it easy to check if the inlet temperature sensor is installed in the inlet pipe. The other white marking is placed at the end of the cable, see the figure below, and can, in connection with reverification, be used for checking that the temperature sensors have subsequently been mounted correctly in the calculator. Identification of inlet and outlet temperature sensors can likewise be seen from the attached sign on the temperature sensors.



9.7 TemperatureSensor 83 – ø5.8 mm pocket sensor with connection head

TemperatureSensor 83 is a ø5.8 mm pocket sensor with connection head consisting of a ø5.8 mm Pt500 temperature sensor, which is connected to a replaceable sensor insert via a 2-wire silicone cable. The sensor insert is mounted in an immersion pocket with mounted connection board, see Figure 13. Connection of 4-wire cable takes place by inserting the cable through the PG coupling in the connection head and installing the 4 wires in the screw terminal on the temperature sensor insert.

TemperatureSensor 83 is delivered with R½ (conical ½”) connection in stainless steel and in lengths of 65, 90, 140 and 180 mm. The outer diameter of the immersion pocket is ø10 mm at the widest point, which makes it possible to mount TemperatureSensor 83 in a pipe extension. The construction with replaceable sensor insert permits replacement of sensors without having to cut off the water flow. Furthermore, the wide range of immersion pipe lengths ensures that the sensors can be mounted in all existing pipe dimensions. The stainless steel pockets can be used for mounting in both PN16 and PN25 installations.

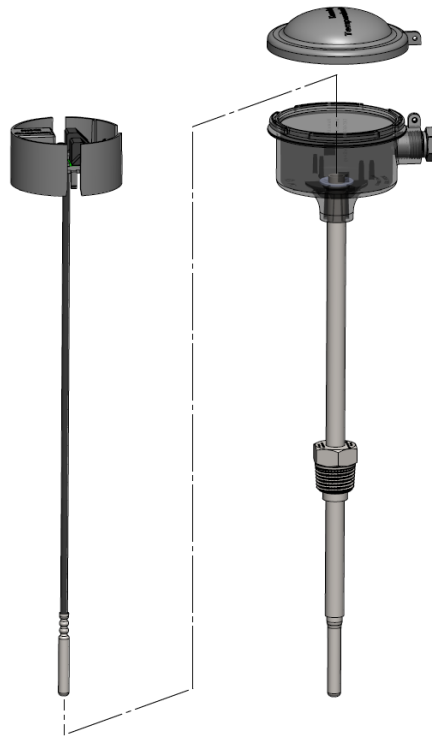

Figure 13: A $\varnothing 5.8$ mm pocket sensor with connection head can, for example, be mounted in a tee as shown in Figure 14.

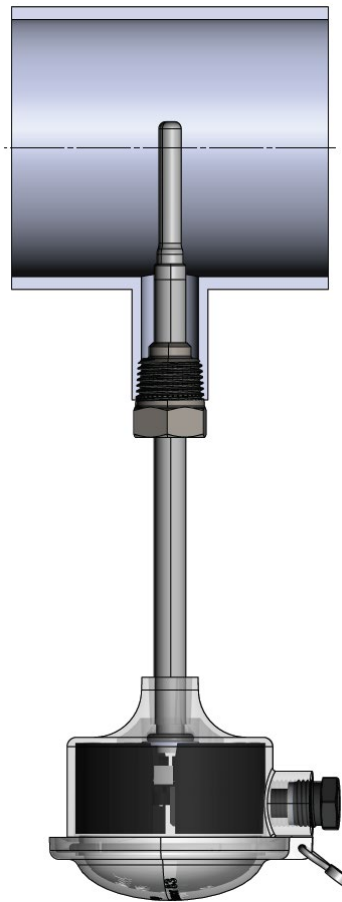

Figure 14

9.8 TemperatureSensor SP 4-wire – ø6 mm EN1434 pocket sensor with connection head

TemperatureSensor SP 4-wire is a ø6 mm pocket sensor with connection head designed according to the instructions in EN1434-2. Both the temperature sensor and the matching sensor pocket are shown in *Figure 15*. The temperature sensor has a diameter of 6 mm and at the end of the temperature sensor, a connection head in aluminium of the type DIN Form B is mounted. The temperature sensor can be delivered both as Pt100 and as Pt500 and when mounted in the matching sensor pocket, it is approved for use in the temperature range 0-180 degrees and in PN16, PN25 and PN 40 installations.

For flow rates up to 3 m/s, a welded stainless steel pocket with a diameter of ø8 mm at the tip is used. At flow rates above 3 m/s or in a PN40 installation, a stainless steel pocket with a diameter of ø10 mm at the tip is used, see *Figure 15*, and that is made of one piece. When mounting, a copper gasket is used to ensure the necessary density. The various installation lengths L for the sensor pocket are shown in *Table 8* in which you can also see the matching installation length EL for the temperature sensor.

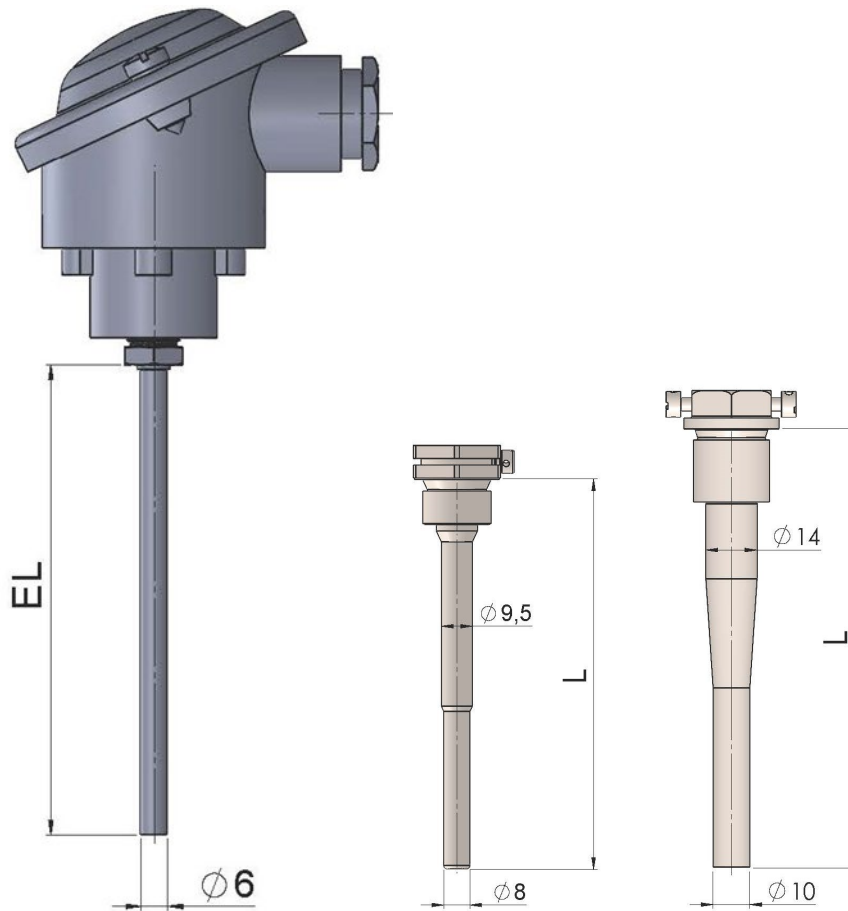

Figure 15: ø6 mm pocket sensor with connection head and matching pockets.

Overall length of ø6 mm sensor – EL	Overall length of ø6 mm pocket – L
105 mm	85 mm
140 mm	120 mm
230 mm	210 mm

Table 8

9.9 Installation of 4 temperature sensors in large pipes

Normally, only one temperature sensor is used in each pipe and this is done assuming that the temperature in the pipe is relatively homogeneous. In large pipes, e.g. above DN100, stratification may occur inside the pipe. The stratification is caused by hot water searching upwards. Stratification becomes more critical at high temperatures due to a larger temperature difference between the medium and the surroundings as well as at low flow rates. In case of stratification, the temperature in the pipe is no longer homogeneous and therefore, a single temperature sensor is not necessarily representative of the average temperature in the pipe. In such cases, the temperature measurement can be improved, by using four temperature sensors connected in a combination of series and parallel connections.

See "Kamstrup's handbook on Temperature sensors for heat and cooling meters" for more details.

9.10 Resistance tables

All values for the ohmic resistance are laid down in the international standard EN 60 751, applying to both Pt100 and Pt500 temperature sensors. The value of the ohmic resistance of a Pt500 sensor is five times higher than that of a Pt100 sensor. The tables below show resistance values in [Ω] for each degree Celsius for Pt100 and Pt500 temperature sensors respectively:

Pt100										
°C	0	1	2	3	4	5	6	7	8	9
0	100,000	100,391	100,781	101,172	101,562	101,953	102,343	102,733	103,123	103,513
10	103,903	104,292	104,682	105,071	150,460	105,849	106,238	106,627	107,016	107,405
20	107,794	108,182	108,570	108,959	109,347	109,735	110,123	110,510	110,898	111,286
30	111,673	112,060	112,447	112,835	113,221	113,608	113,995	114,382	114,768	115,155
40	115,541	115,927	116,313	116,699	117,085	117,470	117,856	118,241	118,627	119,012
50	119,397	119,782	120,167	120,552	120,936	121,321	121,705	122,090	122,474	122,858
60	123,242	123,626	124,009	124,393	124,777	125,160	125,543	125,926	126,309	126,692
70	127,075	127,458	127,840	128,223	128,605	128,987	129,370	129,752	130,133	130,515
80	130,897	131,278	131,660	132,041	132,422	132,803	133,184	133,565	133,946	134,326
90	134,707	135,087	135,468	135,848	136,228	136,608	136,987	137,367	137,747	138,126
100	138,506	138,885	139,264	139,643	140,022	140,400	140,779	141,158	141,536	141,914
110	142,293	142,671	143,049	143,426	143,804	144,182	144,559	144,937	145,314	145,691
120	146,068	146,445	146,822	147,198	147,575	147,951	148,328	148,704	149,080	149,456
130	149,832	150,208	150,583	150,959	151,334	151,710	152,085	152,460	152,835	153,210
140	153,584	153,959	154,333	154,708	155,082	155,456	155,830	156,204	156,578	156,952
150	157,325	157,699	158,072	158,445	158,818	159,191	159,564	159,937	160,309	160,682
160	161,054	161,427	161,799	162,171	162,543	162,915	163,286	163,658	164,030	164,401
170	164,772	165,143	165,514	165,885	166,256	166,627	166,997	167,368	167,738	168,108
180	168,478	168,848	169,218	169,588	169,958	170,327	-	-	-	-

Pt100, IEC 751 Amendment 2-1995-07

Table 9

Pt500										
°C	0	-1	-2	-3	-4	-5	-6	-7	-8	-9
-30	441,116	439,144	437,172	435,199	433,225	431,251	429,276	427,301	425,325	423,349
-20	460,802	458,836	456,869	454,902	452,934	450,966	448,997	447,027	445,057	443,087
-10	480,430	478,469	476,509	474,547	472,585	470,623	468,660	466,696	464,732	462,767
0	500,000	498,046	496,091	494,135	492,179	490,222	488,265	486,307	484,348	482,389
°C	0	1	2	3	4	5	6	7	8	9
0	500,000	501,954	503,907	505,860	507,812	509,764	511,715	513,665	515,615	517,564
10	519,513	521,461	523,408	525,355	527,302	529,247	531,192	533,137	535,081	537,025
20	538,968	540,910	542,852	544,793	546,733	548,673	550,613	552,552	554,490	556,428
30	558,365	560,301	562,237	564,173	566,107	568,042	569,975	571,908	573,841	575,773
40	577,704	579,635	581,565	583,495	585,424	587,352	589,280	591,207	593,134	595,060
50	596,986	598,911	600,835	602,759	604,682	606,605	608,527	610,448	612,369	614,290
60	616,210	618,129	620,047	621,965	623,883	625,800	627,716	629,632	631,547	633,462
70	635,376	637,289	639,202	641,114	643,026	644,937	646,848	648,758	650,667	652,576
80	654,484	656,392	658,299	660,205	662,111	664,017	665,921	667,826	669,729	671,632
90	673,535	675,437	677,338	679,239	681,139	683,038	684,937	686,836	688,734	690,631
100	692,528	694,424	696,319	698,214	700,108	702,002	703,896	705,788	707,680	709,572
110	711,463	713,353	715,243	717,132	719,021	720,909	722,796	724,683	726,569	728,455
120	730,340	732,225	734,109	735,992	737,875	739,757	741,639	743,520	745,400	747,280
130	749,160	751,038	752,917	754,794	756,671	758,548	760,424	762,299	764,174	766,048
140	767,922	769,795	771,667	773,539	775,410	777,281	779,151	781,020	782,889	784,758
150	786,626	788,493	790,360	792,226	794,091	795,956	797,820	799,684	801,547	803,410
160	805,272	807,133	808,994	810,855	812,714	814,574	816,432	818,290	820,148	822,004
170	823,861	825,716	827,571	829,426	831,280	833,133	834,986	836,838	838,690	840,541
180	842,392	844,241	846,091	847,940	849,788	851,635	-	-	-	-

Pt500, IEC 751 Amendment 2-1995-07

Table 10

10 Power supply

MULTICAL® 603 is powered via the two-pole connector in the calculator base. The internal power supply is 3.6 VDC and can be carried out as battery or mains supply via a number of different supply modules from Kamstrup A/S, see the below extract from the type number overview in paragraph 3.1.

Supply modules	
Battery, 1 x D-cell	2
230 VAC High Power SMPS	3
24 VAC/VDC High Power SMPS	4
Battery, 1 x D-cell IoT	5
230 VAC supply module	7
24 VAC supply module	8
Battery, 2 x A-cells	9

All supply modules have been evaluated in connection with the extensive type tests, to which MULTICAL® 603 has been subjected, and it is not permissible to use other supply modules than the ones mentioned above. The supply modules are covered by the CE-marking and the factory guarantee of the meter.

Note: The modules for mains connection must not be connected to direct current (DC), however except for module no. 4 “24 VAC/VDC High Power SMPS”.

10.1 Lithium battery, 2 x A-cells

Battery supply for MULTICAL® 603 can consist of a supply module which uses 2 x A-cell lithium batteries (Kamstrup type HC-993-09). No tools are required in order to mount or replace the battery module. Each battery cell has a lithium content of approx. 0,9 g, which exempts the module from being subject to regulations for transportation of dangerous goods.



The battery lifetime depends on factors like ambient temperature and meter configuration, an indication of battery lifetime is thus a realistic estimate.

MULTICAL® 603

10.2 Lithium battery, 1 x D-cell

In order to obtain the longest possible battery lifetime, MULTICAL® 603 can be fitted with 1 x D-cell lithium battery (Kamstrup type HC-993-02). No tools are required in order to mount or replace the battery module. The lithium content of the battery cell is approx. 4.5 g, which makes the battery subject to regulations on transportation of dangerous goods, see document 5510-408_DK-GB-DE.



The battery lifetime depends on factors like ambient temperature and meter configuration, an indication of battery lifetime is thus a realistic estimate.

10.3 Lithium battery, 1 x D-cell IoT

For particularly current-demanding applications, such as a battery-operated NB-IoT module, D-cell IoT (Kamstrup type HC-993-05) must be used. This battery package consists of a lithium D-cell and a special capacitor that helps the battery to deliver high pulse flows.

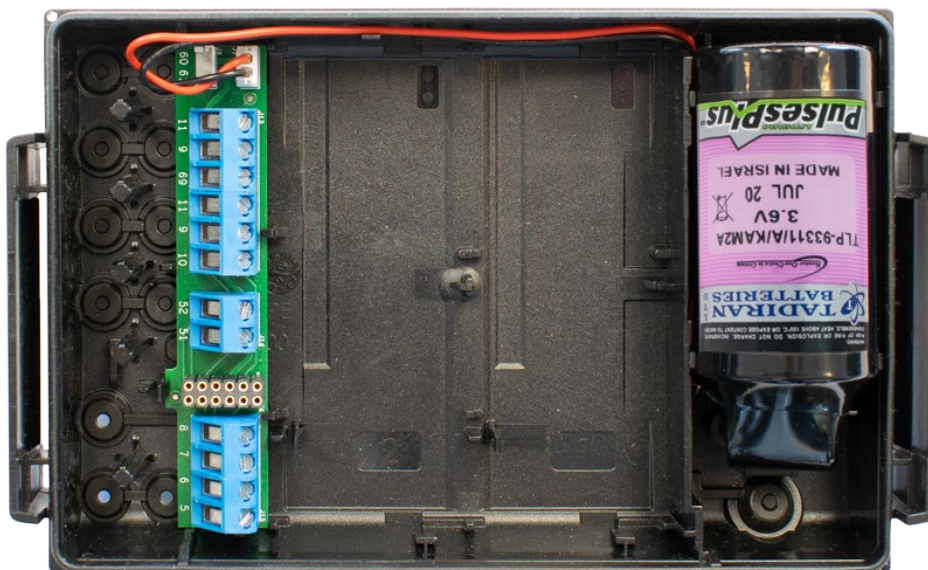

10.4 Battery lifetimes

Overview, estimated lifetime [years], for differently configured MULTICAL® 603 (type 603-E).

Module slot 2 \ Module slot 1		00			10	20	30 ¹	11			21	31 ¹	50, 51	11, 21, 31 ¹	11, 21, 31 ¹	11, 21, 31 ¹						
		00		10		20		30 ¹		11		21		31 ¹		50, 51						
00	No module	1 x D: 16 years 2 x A: 13 years		1 x D: 16 years 2 x A: 9 years		1 x D: 14 years 2 x A: 6 years		1 x D: 10 years		1 x D: 6 years												
10	Data Pulse, inputs (In-A, In-B)	1 x D: 16 years 2 x A: 9 years		1 x D: 15 years 2 x A: 7 years		1 x D: 12 years 2 x A: 5 years		1 x D: 8 years														
20	Wired M-Bus, inputs (In-A, In-B)																					
30 ¹ , 32	Wireless M-Bus, inputs (In-A, In-B), 868 MHz																					
11	Data Pulse, outputs (Out-C, Out-D)	1 x D: 14 years 2 x A: 6 years		1 x D: 12 years 2 x A: 5 years																		
21	Wired M-Bus, outputs (Out-C, Out-D)																					
31 ¹	Wireless M-Bus, outputs (Out-C, Out-D), 868 MHz																					
50, 51	Low Power Radio, inputs (In-A, In-B), 434 MHz																					
11, 21, 31 ¹	Used pulse divider V1/4, PP=73, Avg. Flow ≤ qp/5	1 x D: 10 years		1 x D: 8 years																		
11, 21, 31 ¹	Used pulse transmitter V1, PP=82 eller 83, Avg. Flow ≤ qp/5	1 x D: 6 years																				
11, 21, 31 ¹	Used pulse transmitter V1+V2, PP=80																					

¹ The battery lifetime depends on the chosen datagram.



Mains supply

Modules, which are not included in the overview, require mains supply. See an overview of supply options for modules in paragraph 11.8.

MULTICAL® 603

Conditions for above-mentioned calculations of battery lifetime:

- Wall-mounted calculator ($t_{BAT} < 30^{\circ}C$)
- Pulse output: Pulse duration: 32 ms
- Adaptive (2-64 s) or 32 s integration time
- Data reading: Max 1 reading per hour
- M-Bus reading: Max one reading every 10 seconds
- Display on (LCD ON), no background lighting
- An ULTRAFLOW® 54/44 flow sensor connected with an average flow $\approx qp/4$



Note:

- The battery lifetime of MULTICAL® 603-A/B/C/D/G (with integrated M-Bus) corresponds to the battery lifetime of MULTICAL® 603-E with 1 M-Bus module.
- The battery lifetime of MULTICAL® 603-F (with built-in display backlight, turned on 5x15 s/day) is approx. ½ year shorter than the lifetime of the other types.
- The battery lifetime of MULTICAL® 603-E with wM-Bus, two connected ULTRAFLOW® 54/44 flow sensors and a display that turns off after 4 minutes is 16 year.
- The battery lifetime is typically 14 years in Fast mode (2 s).

Is your application not covered in the above table? Then contact Kamstrup A/S for a specific calculation of the battery lifetime of your application.

Battery lifetimes

Overview, estimated life [years], with differently configured MULTICAL® 603 (type 603-E).

Module slot 2 \ Module slot 1		00	10	20	40	41	43	60	66	67	81	82	83
56	NB-IoT, inputs (In-A, In-B) *2	1 x D: 16 years	1 x D: 15 years										
													



NB-IoT battery



High Power SMPS

Modules that are not shown in the overview require mains supply. See the overview of supply options for modules in paragraph 11.8.

² Depending on the Coverage Extension (CE) level

Examples of CE level influence on battery life for MULTICAL® 603 with daily data transmission.

CE level	Battery life MULTICAL® 603
0	Up to 16 years
1	Up to 15 years
2	Up to 12 years



Figure 16 – CE level exemplified for meters with various positions.

10.5 230 VAC supply module

This module is galvanically separated from the 230 VAC supply, the module is adjusted to direct connection to the electricity network. The module includes a double-chamber safety transformer and fulfils double-isolation requirements when the calculator top is mounted on the calculator base. If the supply is interrupted, the module typically keeps the meter powered for a few minutes, depending on the integration mode (L-code) and the communication type.



If connected to 230 VAC the whole installation must fulfil current national regulations. Connection/disconnection of the module must be carried out by the meter installer. However, note that work on fixed installations, including any intervention in the fuse box, must be carried out by an authorized electrician.

10.6 24 VAC supply module

This module is galvanically separated from the 24 VAC supply, the module is adjusted to industrial installations and installations powered by a separate 230/24 V safety transformer, for instance mounted in a control panel. The module includes a double-chamber safety transformer and fulfils double-isolation requirements when the calculator top is mounted on the calculator base. If the supply is interrupted, the module typically keeps the meter powered for a few minutes, depending on the integration mode (L-code) and the communication type.



The whole installation must fulfil current national regulations. Connection/disconnection of the module can be carried out by the meter installer, whereas installation of the 230/24 VAC safety transformer in a control panel as well as other fixed installations must be carried out by an authorized electrician.

10.7 230 VAC high-power SMPS

This module is galvanically separated from the 230 VAC supply, the module is adjusted to direct connection to the electricity network. The module is constructed as a Switch Mode Power Supply, which complies with the double insulation requirements when the calculator top is mounted on the calculator base. When disconnecting the supply, the module will only keep the meter supplied for a few seconds.



If connected to 230 VAC the whole installation must fulfil current national regulations. Connection/disconnection of the module must be carried out by the meter installer. However, note that work on fixed installations, including any intervention in the fuse box, must be carried out by an authorized electrician.

10.8 24 VDC/VAC high-power SMPS

This module is galvanically separated from the 24 VDC/VAC supply, the module is adjusted to industrial installations and installations powered by a separate 230/24 V safety transformer, for instance mounted in a control panel. The module is constructed as a Switch Mode Power Supply, which complies with the double insulation requirements when the calculator top is mounted on the calculator base. When disconnecting the supply, the module will only keep the meter supplied for a few seconds.



The whole installation must fulfil current national regulations. Connection/disconnection of the module can be carried out by the meter installer, whereas installation of the 230/24 VAC safety transformer in a control panel as well as other fixed installations must be carried out by an authorized electrician.

10.9 Power consumption of mains connected meter

The gained power of meters connected to 24 VAC or 230 VAC appears from the marking on the meter’s front. The marking states an average maximum value for the meter’s gained power, and over a period of time, the power will not exceed the marking. For instance short periods with data communication require a short-term increase of the energy consumption, whereas longer periods without data communication require less energy. The table shows examples of accumulated yearly consumption for MULTICAL® 603 with various supply types. For battery supplied meters, see paragraph 10.4 about battery lifetimes.

	MULTICAL® 603 connected to 24 VAC incl. transformer (66-99-403)	MULTICAL® 603 connected to 24 VAC excl. transformer	MULTICAL® 603 direct connected to 230 VAC
Gained power [W]	< 1,5 W	< 1 W	< 1 W
Apparent power [VA]	< 6 VA	< 7 VA	< 11,5 VA
Yearly consumption [kWh]	Approx. 13 kWh	Approx. 9 kWh	Approx. 9 kWh

10.10 Transformer 230/24 VAC

The supply modules for 24 VAC are adjusted for use with a 230/24 VAC safety transformer e.g. Kamstrup type 66-99-403, which is mounted in a control panel or another separate encapsulation. Regarding power consumption using a safety transformer in connection with 24 VAC supply modules, see paragraph 10.9 about power consumption of mains-connected meters.



The maximum cable length between the 230/24 VAC transformer, e.g. Kamstrup type 6699-403, and MULTICAL®.

Cable type	Max length
2x0,75 mm ²	50 m
2x1,5 mm ²	100 m

10.11 Supply cables for supply module

MULTICAL® 603 can be supplied with supply cable type H03VV-F¹ 2 x 0,75 mm² to be used for both 24 VAC and 230 VAC, if required by the customer. The supply cable to the meter must not be protected by a fuse larger than the one permitted.

In case of doubt, it is recommended to consult an authorized electrician for an evaluation of how to carry out the installation concerned correctly with regard to safety.

¹ H03VV-F is the type designation of PVC-isolated cable, with a nominal voltage of 300/300 V and a max temperature of 70 °C. During installation please remember to keep sufficient distance to hot parts of the installation.

10.12 Retrofitting and exchange of supply modules

Supply modules can be freely exchanged within the possible options in the type number of MULTICAL® 603. For example, it can be an advantage, for a period of time, to switch a mains connected supply module to battery supply in a building that has varying mains supply due to restoration or construction work. However, in some cases, battery supply is not a practical option, e.g. in connection with frequent data communication. It is always possible to exchange from battery supply to mains supply without reconfiguration.

The supply type with which Kamstrup A/S delivered MULTICAL® 603 is permanently laser engraved on the meter. When exchanging the installed supply module, the new supply module is delivered from Kamstrup A/S with labels for fixing to MULTICAL® 603. The label must correspond to the installed supply module, see *Figure 17*. The label is fixed to the area marked on *Figure 18* so that it covers any previously imprinted supply description.

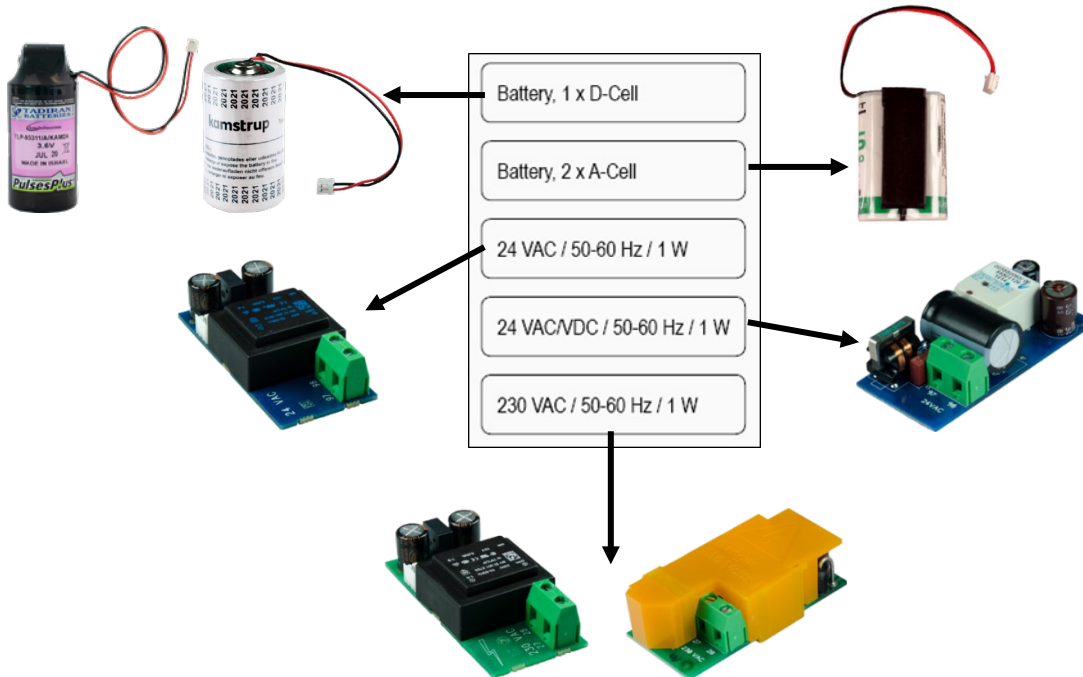

Figure 17 - Choice of correct label for installed supply type

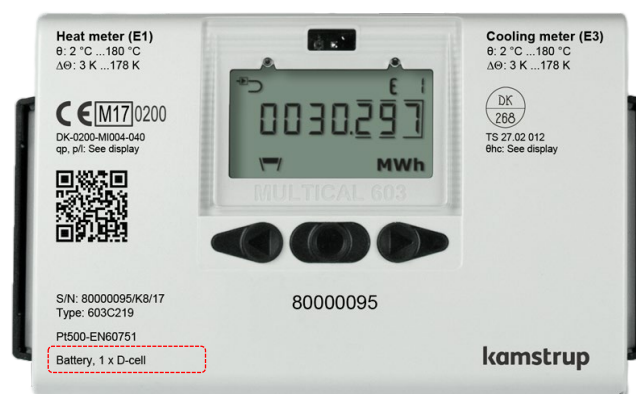

Figure 18 - Correct position of label on MULTICAL® 603

10.13 Data backup in case of interruption of supply

MULTICAL® 603 is fitted with a small lithium battery (BR1632) as backup for the meter's internal clock in case of interruption of the supply. Independent of the mounted supply module the meter is equipped with functionality which saves all current register counts in case the voltage of the internal 3,6 VDC supply is below 3,1 VDC. When the supply is re-established, the meter continues counting from the value, which was saved when the supply was interrupted.

11 Communication

11.1 Integrated M-Bus

Selected variants of MULTICAL® 603 contain an integrated wired M-Bus interface (type 603-A/B/C/D/G). See the meter's complete type number in paragraph 3.1.

The integrated wired M-Bus is designed according to the M-Bus standard EN-13757:2013 and includes the following functions:

- Fixed M-Bus datagram
- Primary and secondary addressing
- Up to 9600 baud communication speed with wild card search and automatic baud rate detection
- Polarity-independent connection
- Load 1 M-Bus Unit Load
- Galvanically separated from the meter's calculator
- Possibility of changing the primary M-Bus address via M-Bus
- Possibility of setting the meter's clock via M-Bus

Register ID (dec)	Datagram
60	Heat energy E1
63	Cooling energy E3
68	Volume V1
86	Inlet temperature t1
87	Outlet temperature t2
89	Differential temperature t1-t2
80	Actual power
74	Actual flow
99/369	Info codes
1004	Operating hour counter
175	Error hour counter
404	Meter type
1001	Serial number

The meter can use both battery and mains supply. In case of battery supply, a reading interval of 10 seconds or higher does not result in a reduction of the meter's specified battery lifetime. Read more about battery lifetimes in paragraph 10.4.

In case of battery supply, it is recommended to use the highest possible communication speed as this results in the lowest power consumption. See paragraph 10.3 for the meters' battery lifetimes.

The primary address can be set either via the meter's front keys or via METERTOOL HCW through the optical readout head. By default, the address is the 2-3 last digits of the meter's customer number.

The secondary address can be set via METERTOOL HCW through the optical readout head. By default, the address is the meter's customer number.

MULTICAL® 603

The M-Bus interface is connected to the M-Bus master on the screw terminals 24 and 25 on the meter's connection PCB.

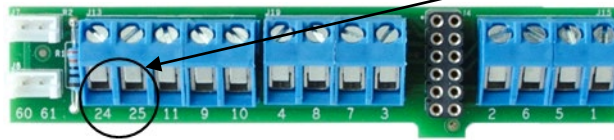

Note It is not possible to read out logger data via integrated M-Bus.

11.2 Communication modules

MULTICAL® 603 has room for two communication modules. All modules are part of the type approval of the MULTICAL® 603. Only type-approved modules must be used, as CE-declaration and factory warranty depends hereof.

The meter automatically detects whether a module has pulse-inputs or pulse-outputs.

Type number	Module name	
HC-003-10	Data Pulse, inputs (In-A, In-B)	
HC-003-11	Data Pulse, outputs (Out-C, Out-D)	
HC-003-20	Wired M-Bus, inputs (In-A, In-B)	
HC-003-21	Wired M-Bus, outputs (Out-C, Out-D)	
HC-003-22	Wired M-Bus, Thermal Disconnect	☞ ⚡ 🔌
HC-003-30	Wireless M-Bus, inputs (In-A, In-B), 868 MHz	☞
HC-003-31	Wireless M-Bus, outputs (Out-C, Out-D), 868 MHz	☞
HC-003-32	linkIQ/wM-Bus, inputs (In-A, In-B), EU	☞
HC-003-33	linkIQ/wM-Bus, outputs (Out-C, Out-D), EU	☞
HC-003-34	wM-Bus, inputs (In-A, In-B), 912,5/915/918,5 MHz	☞
HC-003-40	Analog outputs 2 x 0/4...20 mA	☞ ⚡
HC-003-41	Analog inputs 2 x 4...20 mA / 0...10 V	☞ ⚡
HC-003-43	PQT Controller	☞ ⚡
HC-003-50	Low Power Radio, inputs (In-A, In-B), 434 MHz	☞ 🔌
HC-003-51	Low Power Radio GDPR, inputs (In-A, In-B), 434 MHz	☞ 🔌
HC-003-56	NB-IoT, inputs (In-A, In-B)	☞ 🔋 ⚡
HC-003-58	NB-IoT (Elvaco)	☞ 🔋 ⚡
HC-003-60	LON TP/FT-10, inputs (In-A, In-B)	☞
HC-003-66	BACnet MS/TP, inputs (In-A, In-B)	☞
HC-003-67	Modbus RTU, inputs (In-A, In-B)	☞
HC-003-80	2G/4G Network, inputs (In-A, In-B)	☞ ☞
HC-003-81	BACnet IP, inputs (In-A, In-B)	☞
HC-003-82	Modbus/KMP TCP/IP, inputs (In-A, In-B)	☞
HC-003-83	READY TCP/IP, inputs (In-A, In-B)	☞
HC-003-84	High Power Radio Router, inputs (In-A, In-B), 444 MHz	☞ ☞
HC-003-85	High Power Radio Router GDPR, inputs (In-A, In-B), 444 MHz	☞ ☞

- ☞ The module requires as a minimum that the meter is mains-supplied
- ☞⚡ The module requires that the meter is mains-supplied with a High Power supply
- ⚡ Module requires an external power supply
- 🔌 See Module datasheet for required coding in meter.
- ☞ Module requires an antenna, see chapter **Mounting of antenna**
- 🔋+ Lithium battery with special capacitor

11.3 Marking on communication modules

All module covers are marked, with clear indication on how to connect signal wires, sensors, power supplies etc. to ensure correct function of the module.

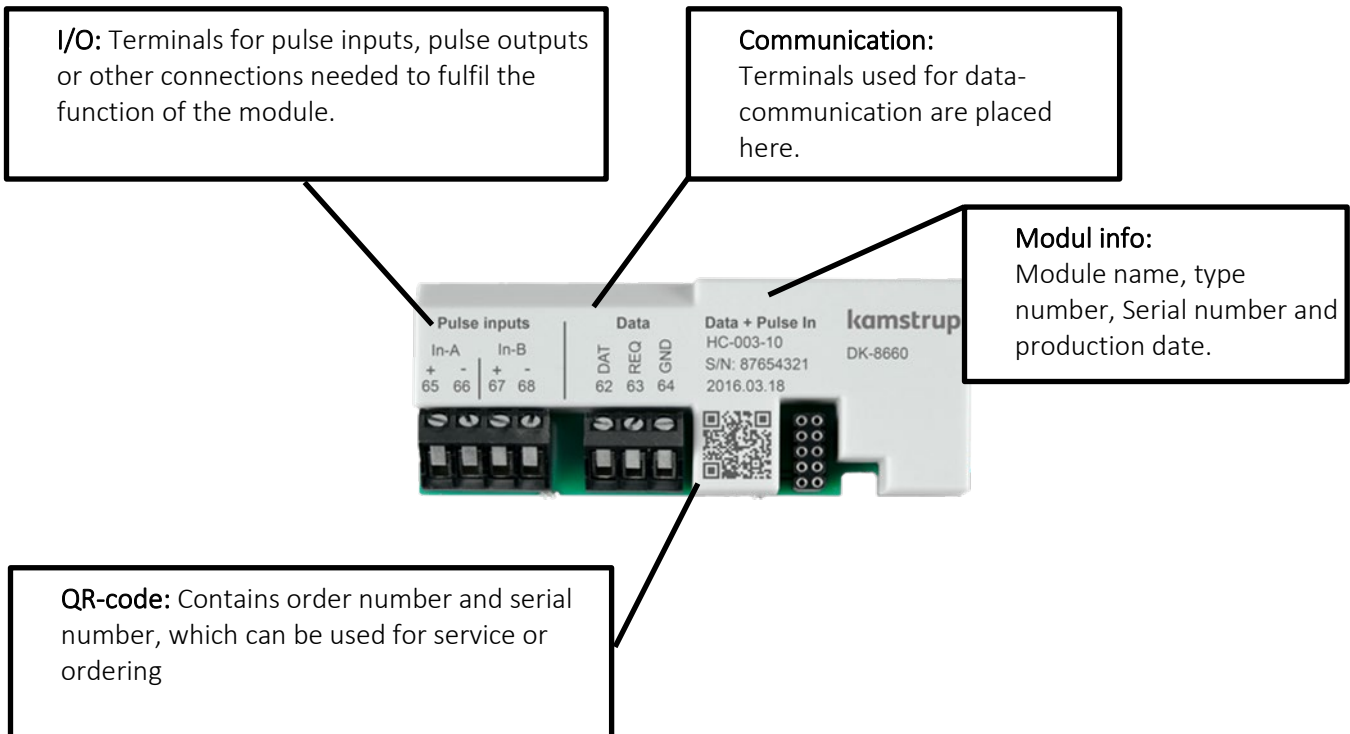

Radio communication modules only have the I/O terminals and a connector for antenna.

For further information on the modules, please refer to their respective datasheets.

For Pulse inputs, see chapter 3.2.6 (**Pulse inputs A and B >FF-GG<**)

For Pulse outputs, see chapter 3.2.10 (**Pulse outputs C and D >PP<**)

11.4 Modules

11.4.1 HC-003-10: Data Pulse, inputs (In-A, In-B)

Data Pulse module enables direct communication to the meter using the KMP protocol.

The module requires a special Kamstrup-communication cable for either RS-232 or USB in order to exchange data.

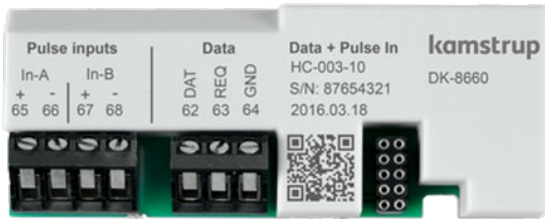

For information about the KMP protocol, see chapter **Data protocol**

11.4.2 HC-003-11: Data Pulse, outputs (Out-C, Out-D)

Data Pulse module enables direct communication to the meter using the KMP protocol.

The module requires a dedicated communication cable for either RS-232 or USB in order to exchange data.

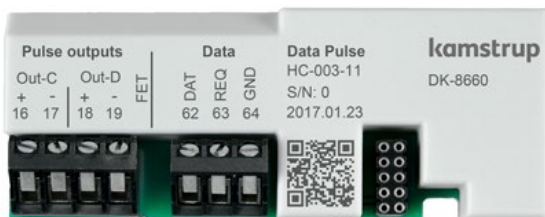

For information about the KMP protocol, see chapter **Data protocol**

11.4.3 HC-003-20: Wired M-Bus, inputs (In-A, In-B)

Wired M-Bus enables communication to battery supplied meters, without affecting the battery lifetime.

The Wired M-Bus module supports primary, secondary and enhanced secondary M-Bus addressing. The module supports automatic baud rate selection among 300,2400,9600 and 19200 baud.

A large selection of datagrams for various applications can be configured into the M-Bus module.



11.4.4 HC-003-21: Wired M-Bus, outputs (Out-C, Out-D)

Wired M-Bus enables communication to battery supplied meters, without affecting the battery lifetime.

The Wired M-Bus module supports primary, secondary and enhanced secondary M-Bus addressing. The module supports automatic baud rate selection among 300,2400,9600 and 19200 baud.

A large selection of datagrams for various applications can be configured into the M-Bus module.

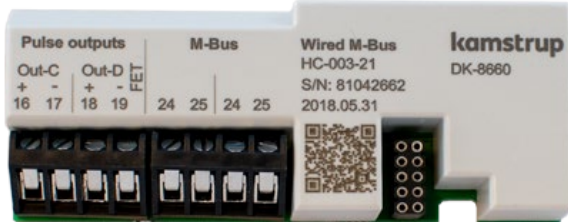

11.4.5 HC-003-22: Wired M-Bus, Thermal Disconnect

Thermal Disconnect enables remote control of flow either for energy-management, or for maintenance purposes. The Thermal Disconnect controls a thermal valve through commands sent via the wired M-bus.



11.4.6 HC-003-30: Wireless M-Bus, inputs (In-A, In-B), 868 Mhz

The Wireless M-Bus module has been developed for Wireless M-Bus systems operating within the licence free band of 868 MHz. Communication is either C-mode or T-mode according to EN13757-4. The Wireless M-Bus module supports individual encryption. Common encryption key is only available upon request.

A large selection of datagrams for various applications can be configured into the Wireless M-Bus module.



▲ This module is replaced by HC-003-32.

11.4.7 HC-003-31: Wireless M-Bus, outputs (Out-C, Out-D), 868 Mhz

The Wireless M-Bus module has been developed for Wireless M-Bus systems operating within the licence free band of 868 MHz. Communication is either C-mode or T-mode according to EN13757-4. The Wireless M-Bus module supports individual encryption. Common encryption key is only available upon request.

A large selection of datagrams for various applications can be configured into the Wireless M-Bus module.



▲ This module is replaced by HC-003-33.

11.4.8 HC-003-32: linkIQ/wM-Bus, inputs (In-A, In-B), EU

This module has been designed with focus on the newest demands for wireless reading. The module is optimized to ensure long battery life. The module can be configured as either wM-Bus or linkIQ. A remote configuration of the datagram is possible using READy Converter.



11.4.9 HC-003-33: linkIQ/wM-Bus, outputs (Out-C, Out-D), EU

This module has been designed with focus on the newest demands for wireless reading. The module is optimized to ensure long battery life. The module can be configured as either wM-Bus or linkIQ. A remote configuration of the datagram is possible using READy Converter.



11.4.10 HC-003-34: wM-Bus, inputs (In-A, In-B), 912,5/915/918,5 MHz

This module has been developed for Wireless M-Bus systems operating within the licence free band in the range 912,5...918,5 MHz.

The modules fulfil the requirements of the M-Bus standard EN 13757:2013.

The module can be configured with different datagrams.



MULTICAL® 603

11.4.11 HC-003-40: Analog outputs 2 x 0/4...20 mA

Analog outputs are often used to pass information to PLC's or similar equipment.

The Analog outputs is based on flow, power or temperatures from the meter. The Analog outputs are individually scale able and configurable as either 0...20 mA or 4...20 mA.



To reduce fluctuations on the analog outputs a larger filter value can be selected using METERTOOL. See chapter **Integration mode >L<**.

The external 24VAC/DC supply is used to supply the analog output circuit.

11.4.12 HC-003-41: Analog inputs 2 x 4...20 mA / 0...10 V

The Analog inputs are for reading and collecting external sensor values to be logged or displayed in the meter. The module accepts both 4..20 mA or 0..10 V signals. Each analog input can be configured individually.



The external 24 VAC/DC supply is used to supply the analog input circuit and the attached sensors.

11.4.13 HC-003-43: PQT Controller

The PQT Controller is for application to optimize energy consumption. The PQT Controller reads the flow, power and temperatures from the meter and together with the configured setpoints the PQT Controller steers an attached motorized valve.



11.4.14 HC-003-50: Low Power Radio, inputs (In-A, In-B), 434 MHz

The Low Power Radio module enables reading of meters via radio-systems operating in the 434 MHz band.

Low Power Radio is designed for Walk-by/Drive-by but are prepared to participate into a Kamstrup radio mesh-network, facilitating automatic transfer of data to the reading system through the network routers and concentrators.

The reading system decides what data to read in the meter.



11.4.15 HC-003-51: Low Power Radio GDPR, inputs (In-A, In-B), 434 MHz

The Low Power Radio module enables reading of meters via radio-systems operating in the 434 MHz band.

Low Power Radio is designed for Walk-by/Drive-by but are prepared to participate into a Kamstrup radio mesh-network, facilitating automatic transfer of data to the reading system through the network routers and concentrators.

The reading system decides what data to read in the meter.

To comply to the GDPR directive, data from the meter are encrypted using individual encryption keys.



11.4.16 HC-003-56: NB-IoT, inputs (In-A, In-B)

The NB-IoT (Narrow Band Internet of Things) module is a point-to-point communication module, that transmits data directly from the meter back to meter reading database using the existing mobile NB-IoT infrastructure.

It is very flexible communication platform that can be used for both battery or main supplied meters, as the transmission interval and datagram can be configured/designed according to customer wishes.

Data can be delivered to our own READy reading solution or to a 3rd party reading solution.

To comply to the GDPR directive, data from the meter are encrypted using individual encryption keys.



MULTICAL® 603

11.4.17 HC-003-58: NB-IoT (Elvaco)

NB-IoT module for transfer of data in NB_IoT networks. The module is developed by Elvaco and has been approved for use in Kamstrup MULTICAL xx3 meters.

▲ Please note that this module is not supplied by Kamstrup, and that questions about this should be addressed to Elvaco AB.



11.4.18 HC-003-60: LON TP/FT-10, inputs (In-A, In-B)

The LON TP/FT-10 module communicates on free topology cables. The communication is compatible with LONWORKS® 2.0 and supports communication speeds up to 78125 bit/s.

The LON module enables reading of meters by building- and industrial-automation systems.



11.4.19 HC-003-66: BACnet MS/TP, inputs (In-A, In-B)

The BACnet MS/TP module are for use on a RS-485 industrial network. The Module is Compatible with ASHRAE 135 and supports communication speeds up to 115200 bit/s.

BACnet module enables reading of meters by building- and industrial-automation systems.



11.4.20 HC-003-67: Modbus RTU, inputs (In-A, In-B)

The Modbus RTU module are for use on a RS-485 industrial network. The Module is Compatible with Modbus implementation guide V1.02 and supports communication speeds up to 115200 bit/s.

Modbus module enables reading of meters by building- and industrial-automation systems.

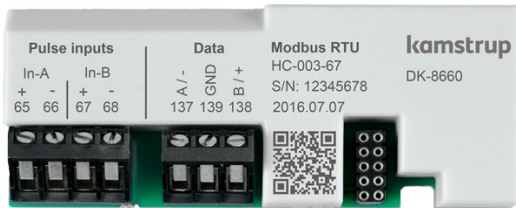

11.4.21 HC-003-80: 2G/4G Network, inputs (In-A, In-B)

The 2G/4G Network is a plug-and-play module. Once the meter is commissioned, the module starts sending hourly data on the 2G- or 4G cellular network.

32 actual values are sent to the utility every hour 24/7/365.

The module comes with 8 years of pre-paid data collection.



The module includes an eternal 2G/4G antenna.

11.4.22 HC-003-81: BACnet IP, inputs (In-A, In-B)

The Module supports BACnet communication via Ethernet.

The BACnet IP enables reading of meters by building- and industrial-automation systems.



11.4.23 HC-003-82: Modbus/KMP TCP/IP, inputs (In-A, In-B)

The Module supports two communication protocols via Ethernet, Modbus TCP and KMP.

Modbus TCP enables reading of meters by building- and industrial-automation systems.

KMP enables reading of actual and logged values, and configurations.



MULTICAL® 603

11.4.24 HC-003-83: REAdy Ethernet, inputs (In-A, In-B)

REAdy Ethernet module is a plug-and-play module. Once the meter is commissioned, the module starts sending hourly data on the ethernet network.

Actual values are sent to the utility every hour 24/7/365.



11.4.25 HC-003-84: High Power Radio Router, inputs (In-A, In-B), 444 MHz

The High Power Radio Router module enables reading of meters via radio-systems operating in the 444 MHz-band. The built-in Router facilitates building of a radio mesh-network between the individual meters and the central concentrator, which manages the radio communication among the meters.

The reading system decides what data to read in the meter.



11.4.26 HC-003-85: High Power Radio Router GDPR, inputs (In-A, In-B), 444 MHz

The High Power Radio Router module enables reading of meters via radio-systems operating in the 444 MHz-band. The built-in Router facilitates building of a radio mesh-network between the individual meters and the central concentrator, which manages the radio communication among the meters.

The reading system decides what data to read in the meter.

To comply to the GDPR directive, data from the meter are encrypted using individual encryption keys.



11.5 Reading high resolution registers

When data reading energy and volume (E1, E3, V1), it is possible to select the default resolution with up to 8 significant digits like on the calculator display. It is also possible to select a reading with up to 9 significant digits (ExtraDigit), which is a ten times higher resolution than on the calculator display.

Furthermore, it is possible to read the internal high-resolution registers ("HighRes").

Below, E1 is used as an example. The same applies to E3 and V1. E1Extra digit is the same value as E1, with just one digit more in the resolution.

Example:

E1	=	1.234.567,8 kWh
E1ExtraDigit	=	1.234.567,89 kWh
E1HighRes	=	4.567.890,1 Wh

11.6 Mounting of antenna

All radio-based modules must have either an internal or external antenna connected.



When mounting an external antenna please ensure that the antenna cable is arranged as shown, to prevent damage of the cable when the meter is assembled.

Before opening the meter to mount a module or an antenna, the power supply must be disconnected.



Wireless M-Bus-module with internal antenna

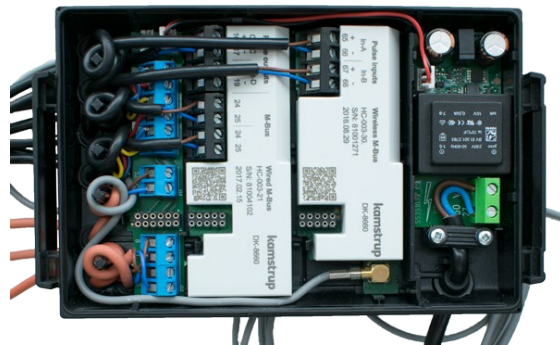

Wireless M-Bus-module with external antenna

11.7 Module retrofitting.

Modules are also sold separately for retrofitting. The modules are preconfigured from the factory and ready to be mounted in the meter. However, some modules might need to be adapted after installation.

This list indicates which changes of module configurations are possible when mounted in the meter. Any changes can be made using METERTOOL HCW and an optical read-out head.

Type number	Module name	Note
HC-003-10	Data Pulse, inputs (In-A, In-B)	-
HC-003-11	Data Pulse, outputs (Out-C, Out-D)	-
HC-003-20	Wired M-Bus, inputs (In-A, In-B)	M+D
HC-003-21	Wired M-Bus, outputs (Out-C, Out-D)	M+D
HC-003-22	Wired M-Bus, Thermal Disconnect	M+D
HC-003-32	linkIQ/wM-Bus, inputs (In-A, In-B), EU	D
HC-003-33	linkIQ/wM-Bus, outputs (Out-C, Out-D), EU	D
HC-003-34	wM-Bus, inputs (In-A, In-B), 912,5/915/918,5 MHz	D
HC-003-40	Analog outputs 2 x 0/4...20 mA	A
HC-003-41	Analog inputs 2 x 4...20 mA / 0...10 V	A
HC-003-43	PQT Controller	A
HC-003-50	Low Power Radio, inputs (In-A, In-B), 434 MHz	D
HC-003-51	Low Power Radio GDPR, inputs (In-A, In-B), 434 MHz	D
HC-003-56	NB-IoT, inputs (In-A, In-B)	-
HC-003-58	NB-IoT (Elvaco)	-
HC-003-60	LON TP/FT-10, inputs (In-A, In-B)	-
HC-003-66	BACnet MS/TP, inputs (In-A, In-B)	A
HC-003-67	Modbus RTU, inputs (In-A, In-B)	A
HC-003-80	2G/4G Network, inputs (In-A, In-B)	-
HC-003-81	BACnet IP, inputs (In-A, In-B)	A
HC-003-82	Modbus/KMP TCP/IP, inputs (In-A, In-B)	A
HC-003-84	High Power Radio Router, inputs (In-A, In-B), 444 MHz	-
HC-003-85	High Power Radio Router GDPR, inputs (In-A, In-B), 444 MHz	-

- M Bus address/M-Bus Primary and M-Bus secondary addresses.
- D Datagram and module software, only by use of Module Programming cable.
- A All module parameters, datagram and software.
- Module has no configuration.

Note: Pulse value and preset of pulse inputs are part of the meter configuration.





The bus addresses are also stored in the meter configuration, allowing a communication module to be replaced without assigning the bus address to the module.





For further information about METERTOOL HCW see technical documentation (5512-2097)



Before opening the meter to mount a module or an antenna, the power supply must be disconnected.

11.8 Supply of modules

Module slot 1 \ Module slot 2		Module slot 2												
		00	10	20	11	21	11	22	40	41	43	66	67	
00	No module													
10	Data Pulse, inputs													
20	Wired M-Bus, inputs													
30 32 34	Wireless M-Bus linkIQ/wM-Bus													
50 51	Low Power Radio, inputs													
11 31 33	Data Pulse, outputs													
21	Wired M-Bus, outputs													
11	Data Pulse, outputs (as pulse transmitter)													
22	Wired M-Bus, Thermal Disconnect													
40	Analog outputs													
41	Analog inputs													
43	PQT Controller													
66	BACnet MS/TP, inputs													
67	Modbus RTU, inputs													
56... 85	56,58,60,82,83,84 and 85													
56 58	NB-IoT (Elvaco)													

-  Battery
-  Minimum mains supply
-  High-power SMPS
-  Battery, IoT

Overview of battery lifetimes, of different configurations is shown in paragraph 10.4.

12 Data communication

12.1 MULTICAL® 603 data protocol

Internal data communication in MULTICAL® 603 is based on the Kamstrup Meter Protocol (KMP) which provides a fast and flexible reading structure and also fulfils future requirements to data reliability.

The KMP protocol is used in all Kamstrup consumption meters launched from 2006 onwards. The protocol is used for the optical reading head and via plug pins for the module area. Thus, modules with e.g. M-Bus interface use the KMP protocol internally and the M-Bus protocol externally.

Integrity and authenticity of data

All data parameters include type, measuring unit, scaling factor and CRC16 checksum.
Every produced meter includes a unique identification number.

12.2 Optical readout head

The optical reading head can be used for data communication via the optical interface. The optical readout head is placed on the front of the calculator just above the IR-diode as shown in the figure below. Note that the optical readout head includes a very strong magnet, which should be protected by means of an iron disc when not in use.

Various variants of the optical readout head appear from the list of accessories (see paragraph 3.1.1).



Power-saving in connection with the optical readout head

In order to limit the power consumption of the circuit around the IR-diode, the meter includes a magnet sensor which switches off the circuit when there is no magnet close to it.

12.3 Data protocol

Utilities and other relevant companies who want to develop their own communication drivers for the KMP protocol can order a demonstration program in C# (.net-based) as well as a detailed protocol description (in English language).

13 Mixed fluid

The MULTICAL® 603 calculator variant "M" (Mixed fluid) can operate in sub-zero temperatures, with a temperature range of -40...+140 °C. In applications where sub-zero temperatures can be expected it is important to select temperature sensors and flow sensor with a suitable temperature range. Mixed fluids have a lower specific heat capacity compared to that of water. Kamstrup's mixed fluid calculator variant can compensate for this and thereby provide precise measurements regardless of the chemical composition in the installation.

The mixed fluid calculator variant can be delivered with the same known meter types, e.g. heat, cooling and heat/cooling, but neither the MID (Measurement Instrument Directive) or national approvals applies for mixed fluid meters, so these meters are not allowed to be labeled with any approval marking on the meter front. However the meter is tested in accordance to EN1434 and a calibration certificate is available as well.

MULTICAL® 603 calculator variant "M" is compatible with the most commonly used antifreeze liquids, e.g. ethylene glycol and propylene glycol. The type of antifreeze liquid and the concentration are freely programmable, and thus the MULTICAL® 603 can compensate for the unique specific heat capacity in each application, ensuring a high accuracy regardless of the chemical composition of the application. From factory the calculator is programmed with a 4 digit fluid type code, which states what fluid type and concentration level. The 4 digit fluid type code can be viewed in the calculator's display (reference number 71). New fluid types are added continuously, and therefore, the complete overview of compatible fluid types can be viewed online at

www.kamstrup.com/en-en/heat-solutions/meters-devices/meters/multical-603/documents

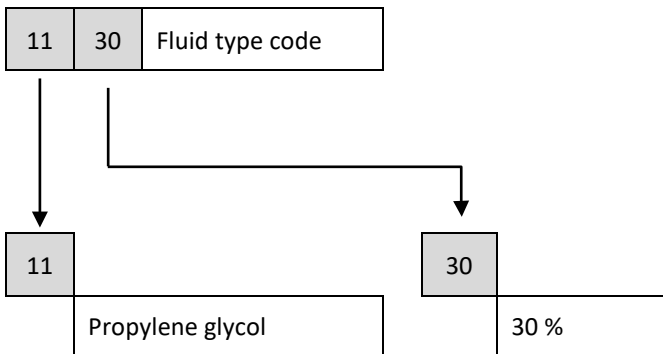

13.1 Type number

Shown below is the type number available for this calculator type "M".

MULTICAL® 603 Mixed fluid type number

		Static data		Dynamic data	
		603-xxxx		xxxxxxx	
		Written on the meter's front		Can be displayed	
		Type 603	-	-	-
Calculator type		□	-	□	-
Pt500 2-wire	t1-t2-t3	V1-V2	Mixed fluid only	M	
Meter type					
Heat meter				2	
Heat/cooling meter		Θ _{HC} = OFF		3	
Cooling meter				5	
Heat/cooling meter		Θ _{HC} = ON		6	
Country code					
See paragraph 3.3			XX		
Flow sensor connection type					
Prepared for flow sensor with fast and bounce-free electronic pulses				C	
Prepared for flow sensor with slow and bounce-free electronic pulses				J	

MULTICAL® 603

MULTICAL® 603 Mixed fluid type number

		Static data 603-xxxx Written on the meter's front				Dynamic data xxxxxxxxx Can be displayed							
		Type 603 -	□	-	□	-	□□	-	□	-	□□	-	□□
Prepared for flow sensor with slow pulses with bounce													
Delivered with one flow sensor		Mixed fluid only											
Temperature sensor set													
Delivered without temperature sensors											00		
2-wire Pt500 temperature sensor pair													
Short direct sensor pair	27,5 mm										51		
Short direct sensor pair	27,5 mm										52		
Short direct sensor pair (3 pairs)	27,5 mm										55		
Short direct sensor pair (3 pairs)	27,5 mm										56		
Pocket sensor pair	∅5,8 mm										81		
Pocket sensor pair	∅5,8 mm										82		
Pocket sensor pair	∅5,8 mm										83		
Pocket sensor pair	∅5,8 mm										84		
Pocket sensor pair (3 pairs)	∅5,8 mm										85		
Pocket sensor pair (3 pairs)	∅5,8 mm										86		
Pocket sensor pair (3 pairs)	∅5,8 mm										87		
Pocket sensor pair (3 pairs)	∅5,8 mm										88		
4-wire Pt500 temperature sensor pair													
Pocket sensor pair with connection head	PL ∅5,8 mm										C1		
Pocket sensor pair with connection head	PL ∅5,8 mm										C2		
Pocket sensor pair with connection head	PL ∅5,8 mm										C3		
Pocket sensor pair with connection head	PL ∅5,8 mm										C4		
Supply													
No supply													0
Battery, 1 x D-cell													2
230 VAC high-power SMPS													3
24 VAC/VDC high-power SMPS													4
Battery, 1 x D-cell IoT													5
230 VAC power supply													7
24 VAC power supply													8
Battery, 2 x A-cells													9
Communication module (2 module slots)													
No module													00
Data Pulse, inputs (In-A, In-B)													10
Data Pulse, outputs (Out-C, Out-D)													11
Wired M-Bus, inputs (In-A, In-B)													20
Wired M-Bus, outputs (Out-C, Out-D)													21
Wired M-Bus, Thermal Disconnect													22
linkIQ/wM-Bus, inputs (In-A, In-B), EU													32
linkIQ/wM-Bus, outputs (Out-C, Out-D), EU													33
wM-Bus, inputs (In-A, In-B), 912,5/915/918,5 MHz													34
Analog outputs 2 x 0/4...20 mA													40
Analog inputs 2 x 4...20 mA / 0...10 V													41
PQT Controller													43
Low Power Radio, inputs (In-A, In-B), 434 MHz													50
Low Power Radio GDPR, inputs (In-A, In-B), 434 MHz													51
NB-IoT, inputs (In-A, In-B)													56
NB-IoT (Elvaco)													58
LON TP/FT-10, inputs (In-A, In-B)													60
BACnet MS/TP, inputs (In-A, In-B)													66
Modbus RTU, inputs (In-A, In-B)													67
2G/4G Network, inputs (In-A, In-B)													80
BACnet IP, inputs (In-A, In-B)													81
Modbus/KMP TCP/IP, inputs (In-A, In-B)													82
High Power Radio Router, inputs (In-A, In-B), 444 MHz													84
High Power Radio Router GDPR, inputs (In-A, In-B), 444 MHz													85

13.2 Configuration number

Shown below is the configuration number available for this calculator type "M".

MULTICAL® 603 Mixed fluid configuration number:

	A	B	CCC	DDD	EE	FF	GG	L	M	N	PP	RR	T	WWW
Flow sensor position														
Inlet	3													
Outlet	4													
Measuring unit														
GJ		2												
kWh		3												
MWh		4												
Gcal		5												
Static CCC codes														
Reed switch (7 digits)			0xx											
Electronic, fast pulse (7 digits)			1xx											
Electronic, fast pulse (8 digits)			2xx											
Electronic, slow pulse (7 digits)			9xx											
Display														
Heat meter (standard)				205										
Heat/cooling meter (standard)				305										
Cooling meter (standard)				505										
Heat/cooling meter (standard)				605										
Tariffs														
No active tariff					00									
Power tariff					11									
Flow tariff					12									
t1-t2 tariff					13									
Inlet tariff					14									
Outlet tariff					15									
Time controlled tariff					19									
Heat/cooling volume tariff					20									
PQ-tariff					21									
Pulse inputs A and B														
10 m ³ /h, 10 l/imp, pre-counter 1 (standard)						24	24							
Integration mode														
Adaptive mode (2-64 s)		Display on						1						
Normal mode (32 s)		Display on						2						
Fast mode (8 s)		Display on						3						
Fast mode (2 s)		Display on						4						
Adaptive mode (2-64 s)		Display off						5						
Normal mode (32 s)		Display off						6						
Fast mode (8 s)		Display off						7						
Leakage limits (V1/V2)														
OFF										0				
1,0 % of qp + 20 % of q										1				
1,0 % of qp + 10 % of q										2				
0,5 % of qp + 20 % of q										3				
0,5 % of qp + 10 % of q										4				
Leakage limit, cold water (In-A/In-B)														
OFF												0		
30 min. without pulses												1		
One hour without pulses												2		
Two hours without pulses												3		
Pulse outputs C and D														
Out-C: V1/4					5 ms									73
Out-C: V1/1, Out-D: V2/1					3,9 ms									80
Out-C: V1/1					3,9 ms									82
Out-C: V1/4					22 ms									83
E1 and V1 or E3 and V1														
E1 and V1 or E3 and V1					10 ms									94
E1 and V1 or E3 and V1					32 ms									95
E1 and V1 or E3 and V1					100 ms (0.1 s)									96
Controlled output based on data commands														99

	RR	T	VVV
Data logger profile 1			
Standard data logger profile	10		
Current values	11		
Ludwig	12		
Madrid	13		
Peter	14		
Diagnostic	15		
Kiev	17		
Information sensitive	18		
Encryption level			
Individual key		3	
Customer label			
See paragraph 3.2.13			0000

¹ For more data logger profiles, see document "Logger profiles and datagrams" at: www.kamstrup.com/en-en/product-centre

13.3 Tariffs

As the mixed fluid calculator MULTICAL® 603-M has a temperature range that goes below 0 °C, the tariff limits and the corresponding functionality has been adapted to reflect this compared to the rest of the MULTICAL® 603 portfolio.

In the standard meters meant for use with water as the heat conveying liquid TA4 can be turned off by setting TL4 to 0,00 °C, this will still be the case for the mixed fluid calculators. This means that the a tariff limit of 0,00 °C cannot be obtained for TA4/TL4, if required it must be set to -0,01 °C or 0,01 °C.

Setting up negative temperature limits for the tariffs is done during the order process or in METERTOOL HCW with clear marking of a negative sign in front of the tariff limit value. But as the tariff limits are implemented into the "SETUP loop" it is necessary to indicate positive/negative values in the display. The indication is made with a – in front of the negative values and a _ in front of positive values. The underscore is flashing when setting up the sign, _ will indicate the "cursor"-position in the "SETUP loop". See example in Figure 19 and Figure 20.



Figure 21 - Setting up positive TL2 in "SETUP loop", the _ will be flashing when on the sign position but disappear when moving to another decimal.



Figure 22 - Setting up negative TL2 in "SETUP loop", the - will be flashing when on the sign position and stay on when moving to another decimal.

Note: The range for t_5 and θ_{hc} remains unchanged in MULTICAL® 603-M in comparison with the existing MULTICAL® 603 portfolio ($t_5 = 0,01...185,00$ °C and $\theta_{hc} = 2,00...180,00$ °C).

13.4 Volume weighted average temperatures

Since the temperatures in the MULTICAL® 603-M can be both positive and negative the volume weighted average temperature calculations will not work and thus E8, E9, E10 and E11 will always be fixed at a value set to 0. Same goes for the display average temperatures for month and year (tm and ty).

Note: Display codes (DDD), logger profiles and communication datagrams dedicated for the mixed fluid calculators will not contain E8, E9, E10, E11, tm and ty, as these registers will be 0 and give no valuable information.

14 Test and calibration

MULTICAL® 603 can be tested as a complete energy meter or as a split meter depending on the available equipment.

The high-resolution test registers are read from the display, via serial data reading or via high-resolution pulses.

When testing a split meter, a separate test of the calculator by means of Kamstrup calibration equipment for MULTICAL® 603 and METERTOOL HCW can be carried out. Flow sensor and temperature sensors are tested separately too.

Integration speed

When configuring the meter, you select the integration mode, which the meter can use under “Integration mode >L<”. Irrespective of the selected Integration mode, the meter can be set to “Test mode” by breaking the test seal and activating the test switch. In “Test mode”, the meter uses a 2-second integration interval just as in “Fast mode (2 s)”. The meter remains in test mode until the supply is disconnected and the meter is restarted, or for 9 hours.

When the meter is in “Test mode”, you can initiate an auto-integration by making a forced dial-up (both arrow keys are pressed until “CALL” is shown in the display).

Integration mode	Interval	L=
Adaptive mode	2-64 s	1
Normal mode	32 s.	2
Fast mode	8 s.	3
Fast mode	2s	4
Adaptive mode	2-64 s	5
Normal mode	32 s.	6
Fast mode	8 s.	7

Temperature calibration

The temperature measurement is adjusted and calibrated during the production process and it does not require further adjustment in the meter’s lifetime. The temperature circuit can only be adjusted in our factory.

Pulse interface

During test, either optical readout head with USB plug (6699-099) for serial reading of high-resolution energy and volume registers or Pulse Interface (6699-143) with optical readout head and connection unit for high-resolution pulse outputs is used. Do not forget that the meter must be in test mode.

The high-resolution registers that are provided as output from Pulse Interface always follow the nominal flow size of the flow sensor that MULTICAL® 603 is configured for.

Flow sensor size	High resolution (pulses)	
$qp \leq 1,5$	0,001 kWh	0,01 litres
$1,5 < qp \leq 15$	0,01 kWh	0,1 litres
$15 < qp \leq 150$	0,1 kWh	1 litres
$150 < qp \leq 1500$	1 kWh	0,01 m ³
$1500 < qp \leq 15000$	0,01 MWh	0,1 m ³

Tabel 11: High resolution for high-resolution meter count registers provides output, depending on the flow sensor size



Verification pulses

When Pulse Interface type 6699-143 is connected to power supply or battery, the unit is placed on the meter, and the meter is in test mode, the following pulses are transmitted:

- High-resolution energy pulses:
¹ (0,001 kWh/pulse to 0,01 MWh/pulse) on terminals 7 and 8

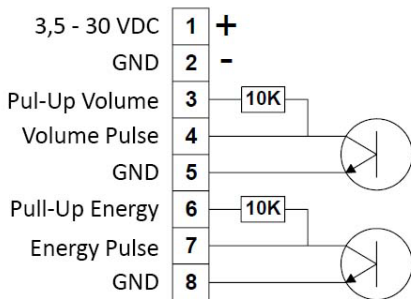

- High-resolution volume pulses:
¹ (0,01l/pulse to 0,1 m³/pulse) on terminals 4 and 5

Pulse Interface 6699-143, technical data

Supply voltage	3,5 – 30 VDC
Current consumption	< 15 mA
Pulse outputs	< 30 VDC < 15 mA
Pulse duration	3,9 ms

¹ See table 2 paragraph 6.4

High-resolution registers for calibration and verification

When the meter is calibrated or verified on equipment such as NOWA, it is necessary to use a higher resolution of energy and volume than shown in the display to reduce the test time.

These high-resolution registers are described in the KMP data protocol description, which can be requested from Kamstrup.

True energy calculation

During test and verification, the heat meter's energy calculation is compared to the "true energy", which is calculated according to the formula of EN1434-1:2007, EN1434-1:2015 and OIML R75:2002.

The below-mentioned energy calculator can be supplied electronically by Kamstrup A/S.

The true energy at the most frequently used verification points is indicated in the table below:

t1 [°C]	t2 [°C]	$\Delta\Theta$ [K]	Inlet [Wh/0,1 m ³]	Outlet [Wh/0,1 m ³]
42	40	2	230,11	230,29
43	40	3	345,02	345,43
53	50	3	343,62	344,11
50	40	10	1146,70	1151,55
70	50	20	2272,03	2295,86
80	60	20	2261,08	2287,57
160	40	120	12793,12	13988,44
160	20	140	14900,00	16390,83

15 Approvals

15.1 Type approvals

MULTICAL® 603 is type-approved according to MID on the basis of EN 1434-4.

MULTICAL® 603 has a national Danish cooling approval, TS 27.02 012, according to BEK 1178 based on EN1434.

15.2 The Measuring Instruments Directive

MULTICAL® 603 is available with CE-marking according to MID (2014/32/EC). The certificates have the following numbers:

B-Module: DK-0200-MI004-040

D-Module: DK-0200-MID-D-001

16 Troubleshooting

MULTICAL® 603 has been constructed with a view to quick and simple installation as well as long and reliable operation at the heat consumer.

Should you, however, experience an operating problem, the table below can be used for troubleshooting.

Should it be necessary to repair the meter, it is recommended only to replace battery, temperature sensors and communication modules. Alternatively, the whole meter should be replaced.

Major repairs must be made by Kamstrup A/S.

Before sending us a meter to be repaired or checked, please use the error detection table below to help you clarify the possible cause of the problem.

Symptom	Possible reason	Proposal for correction
No display function (empty display)	Power supply missing	Change battery or check mains supply. Does the supply plug provide 3.6 VDC?
No energy accumulation (e.g. MWh) and volume (m ³)	Read "INFO" in the display	Check the error indicated by the info code (see paragraph 7.7)
	If "INFO" = 00000000	Check that the flow direction matches the arrow on the flow sensor.
	If "INFO" = xXxxxxxx, xxXxxxxx or xXXxxxxx.	Consult the "INFO" overview (paragraph 7.7) and check the temperature sensors. If defective, replace the sensor pair.
Accumulation of volume (m ³) but not of energy (e.g. MWh)	Read "INFO" in the display	"INFO" = x99xxxxx means invalid temperature difference (t1-t2)
	Inlet and outlet sensors have been interchanged in either installation or connection	Mount the sensors correctly
	Heat/cooling cut-off θ_{hc} has been configured to a too low value	Reconfigure θ_{hc} at a suitable value, or configure θ_{hc} at 250 °C, thereby disconnecting the cut-off function.
Incorrect accumulation of volume (m ³)	Faulty configuration of pulse figure	Check that the pulse figure on the flow sensor matches the calculator.
Incorrect temperature reading	Defective temperature sensor	Replace sensor pair
	Insufficient installation	Check the installation
Temperature indication a little too low, or accumulation of energy (e.g. MWh) slightly too low	Bad thermal sensor contact Heat dissipation Too short sensor pockets	Make sure that the sensors are pushed to the bottom of the sensor pockets Insulate sensor pockets Replace by longer pockets
The optical interface does not respond.	Optical interface disabled	See the heart beat and status indication in paragraph 6.
	Optical readout head is positioned incorrectly	Turn the optical readout head so that the cable turns upwards.

17 Disposal

Kamstrup A/S holds an environmental certification according to ISO 14001, and as part of our environment policy we use materials which can be recovered environmentally correctly to the greatest possible extent.

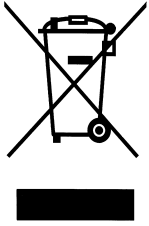

As from August 2005 Kamstrup's heat meters are marked according to EU Directive 2012/19/EU and the standard EN 50419.

The purpose of the marking is to inform our customers that the heat meter cannot be disposed of as ordinary waste.

- **Disposal**

Kamstrup A/S accept end-of-life MULTICAL® 603 for environmentally correct disposal according to previous agreement. The disposal arrangement is free of charge to the customer, except for the cost of transportation to Kamstrup A/S or the nearest disposal system.

The meters should be disassembled as described below and the separate parts handed in for approved destruction. The batteries must not be exposed to mechanical impact and the lead-in wires must not be short-circuited during transport.

Item	Material	Recommended disposal
2 x A lithium cells	Lithium and thionyl chloride, approx. 2 x 0.96 g lithium	Approved deposit of lithium cells
D-cell lithium battery	Lithium and thionyl chloride, >UN 3090<: approx. 4.5 g lithium	Approved deposit of lithium cells
PCBs in MULTICAL® 603 (LC-display to be removed)	Coppered epoxy laminate, components soldered on	PCB scrap for metal recovery
LC-display	Glass and liquid crystals	Approved processing of LC-displays
Cables for flow sensor and temperature sensors	Copper with silicone mantle	Cable recovery
Top cover	PC + 10 % GF	Plastic recycling or combustion
PCB case and connecting base	PC + 10 % GF with TPE gaskets	Plastic recycling or combustion
Wall bracket	PC + 20 % glass	Plastic recycling or combustion
Meter case Clamp plate Transducer/reflector	> 84 % brass or stainless steel, material no. 1.408 < 15 % common steel (St 37) < 1 % stainless steel	Metal recovery
Packing	Environmental cardboard	Cardboard recycling
Packing	Polystyrene	EPS recovery

Please send any questions you may have regarding environmental matters to:

Kamstrup A/S
 Att.: Quality and environmental dept.
 Fax: +45 89 93 10 01
 info@kamstrup.com

18 Documents

	Danish	English	German
Technical description	5512-2028	5512-2029	5512-2030
Data sheet	5810-1515	5810-1516	5810-1517
Installation and user's guide	5512-2231	5512-2231	5512-2231

These documents are currently updated. Find the latest edition at

www.kamstrup.com/en-en/product-centre

