

DAF 516



Differential pressure controllers

With adjustable set-point – for installation in the supply pipe

DAF 516

This compact differential pressure controller for heating and cooling systems is particularly effective in situations requiring high temperatures and/or pressure drop. DAF 516 can be used both on the primary and secondary side in district heating and comfort cooling systems. Rust protection is assured thanks to the electrophoretic painted ductile iron body.

Key features

> Inline design

Inline flow allows high pressure drops without noise.

> Adjustable set-point

Delivers desired differential pressure ensuring accurate balancing.



Technical description

Application:

Heating and cooling systems.
Installation in supply pipe.

Functions:

Differential pressure control
Pre-setting Δp over the load (Δp_L)

Dimensions:

DN 15-125

Pressure class:

DN 15-50: PN 25
DN 65-125: PN 25 / PN 16

Max. differential pressure (Δp_V):

1600 kPa = 16 bar

Setting range:

Δp over the load is adjustable within:
5-30 kPa, 10-60 kPa, 10-100 kPa or
60-150 kPa.

Delivery setting:

DN 15-50: Maximum value (30, 60, 100
resp. 150 kPa).

DN 65-125: Midway min./max. value
(~18, ~35, ~55 resp. ~105 kPa).

Temperature:

Max. working temperature: 150°C
Min. working temperature: -10°C

Media:

Water or neutral fluids, water-glycol
mixtures (0-57%).

Material:

Valve body: Ductile iron EN-GJS-400-15
Diaphragms and gaskets: EPDM
Adjustment ring: DN 15-50 Ryton PPS,
DN 65-125 R St 37-2 steel.

Surface treatment:

Electrophoretic painting.

Marking:

IMI TA, DN, PN, Material, Kvs, Δp and
flow direction arrow.

Connection:

DN 15-50: Male threads according to
ISO 228.

DN 65-125: Flanges according to
EN-1092-2, type 21. Face to face length
according to EN 558 series 1.

Operating function

The pressure upstream of the load acts through an external capillary pipe ($\Delta p+$) on the plus side of the diaphragm (1) and attempts to close the valve.

The pressure downstream of the load acts through an external capillary pipe ($\Delta p-$) in the valve body and attempts, together with the spring (2) force, to open the valve. In this way, the differential pressure over the load is kept constant on the set value.

The spring force can be adjusted by turning the adjustment ring (3). Adjustment can be fixed (DN 15-50) by tightening the fixing screw (4).

DAF 516 should be mounted in the supply pipe upstream of the heat exchanger and STAD (STAF) on the return pipe, but downstream of the control valve. Function is the same as for DA 516, except that the pressure downstream the load acts through the another external copper impulse pipe ($\Delta p-$) to the minus side of the diaphragm. DAF 516 acts in this way as pressure controller (reducing valve) as well.

DN 15-50

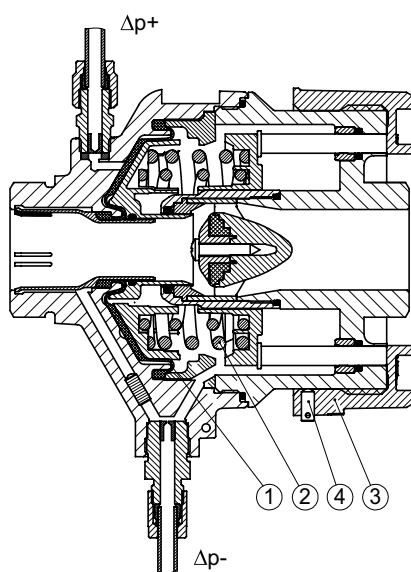

DN 65-125

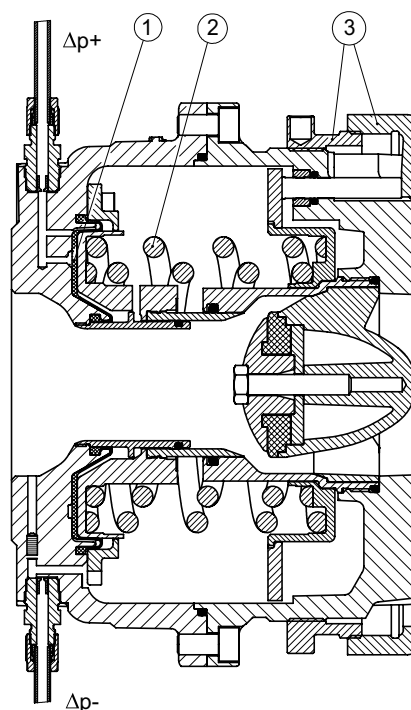

Sizing

1. Select the smallest size for the designed flow according to the diagram.
 2. Check that the available Δp is bigger than the pressure drop of the valve at the designed flow.
- The pressure drop can be found in the diagram or calculated by the formula:

$$\Delta p = \left(\frac{q}{100 \times Kvs} \right)^2 \quad [\text{kPa, l/h}]$$

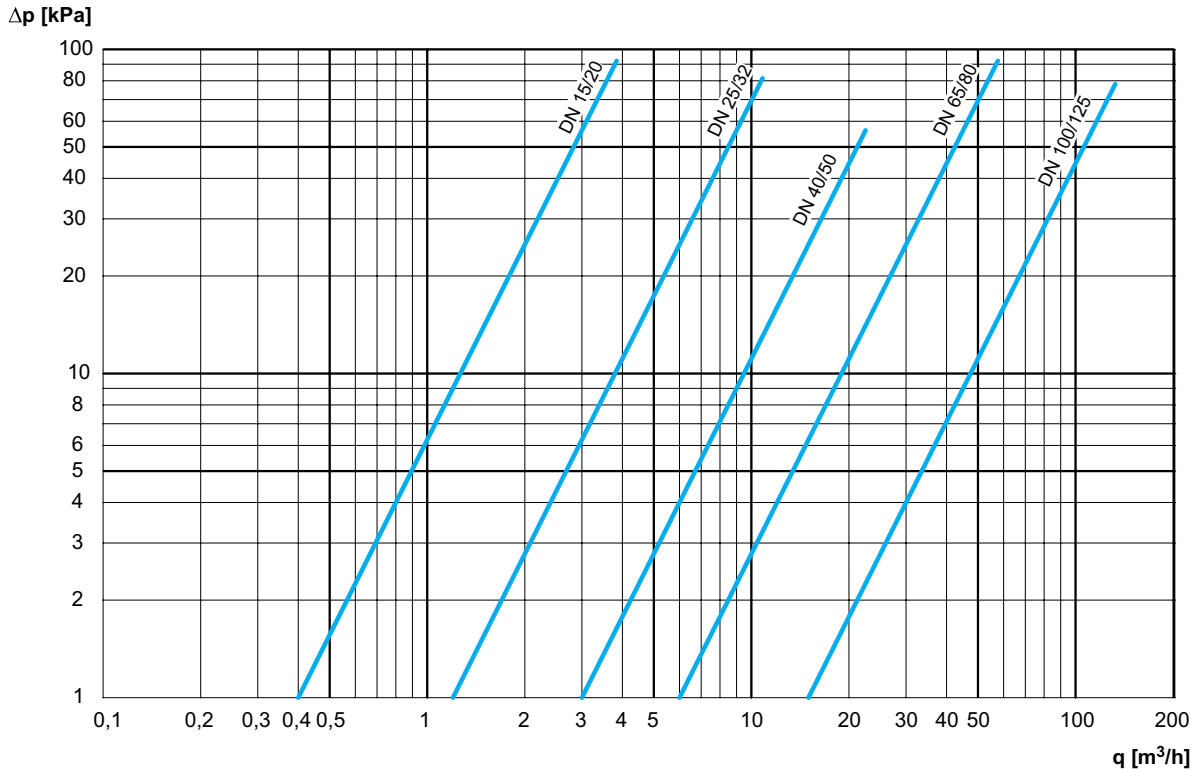

Installation

The DAF 516 must be installed in the supply pipe. Flow direction is shown by the arrow (11) on the valve's identification label (10). The best position is horizontal with the venting screws (2) pointing upwards.

Installation of a strainer upstream of the valve is recommended. Connect capillary pipe ($\Delta p+$, copper $\text{Ø}6 \times 1$) to the pipeline upstream of the load. Connect the other capillary pipe ($\Delta p-$, copper $\text{Ø}6 \times 1$) downstream the load.

In case of a horizontal pipeline connect the capillary pipe laterally to prevent air and dirt from entering.

When filling, vent the body by using the venting screws (2).

In case of valves DN 15-50, turn the adjustment ring (5) clockwise until stop to make the nut (7) on the outlet side accessible.

Note: When welding the connections (DN 15-50) the valve must be protected from too high temperature.

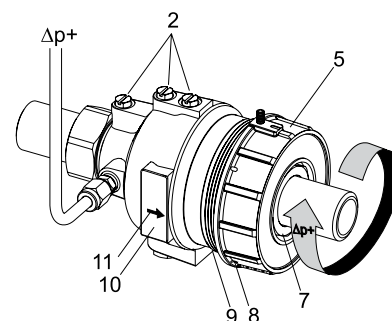

Capillary pipe

Before putting into operation, the capillary pipe must be installed.

- Capillary pipe ($\Delta p-$) is connected to the balancing valve STAD/STAF or other suitable point to the pipeline, **downstream** of the load.
- Capillary pipe ($\Delta p+$) is connected to the other suitable point to the pipeline, **upstream** of the load.

Setting

The differential pressure can be adjusted by turning the adjustment ring (5). The preset value can be sealed through the holes (see (8) and (9) under Installation).

DN	Number of turns	Δp [kPa] change per turn of setting nut/spanner			
		5-30	10-60	10-100	60-150
15/20	10	2,6	5,1	9,3	9,3
25/32	14	1,8	3,6	6,6	6,6
40/50	15	1,7	3,3	6,0	6,0
65	6,5	3,8	7,7	13,8	13,8
80	6,5	3,8	7,7	13,8	13,8
100	6,5	3,8	7,7	13,8	13,8
125	6,5	3,8	7,7	13,8	13,8

Measure flow and adjust Δp accordingly.

Application example

Keeping the differential pressure over a control valve constant

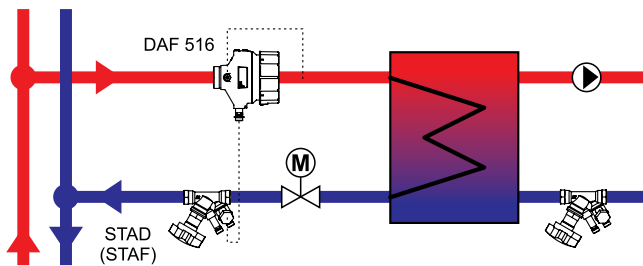

Heat exchanger

DAF 516 should be mounted in the supply pipe upstream of the heat exchanger and STAD (STAF) on the return pipe, but downstream of the control valve. DAF 516 acts in this way as pressure controller (reducing valve) as well.

Articles

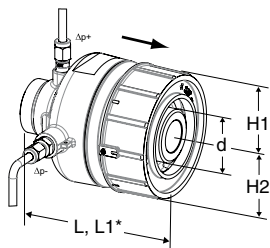
**DN 15-50**

Male thread – Separate connections optional. Male threads according to ISO 228.

Included: Capillary pipe (Ø6) 2 x 1 200 mm, connection set (G1/2+G3/4) for capillary pipe to e.g. STAD and 2 capillary pipe connections R1/4 (R1/8 mounted on valve).

PN 25

DN	d	L	L1*	H1	H2	Kvs	Kg	EAN	Article No
5-30 kPa									
15/20	G1	106	116	41	52	4	1,5	3831112505476	52 763-120
25/32	G1 1/4	125	150	51	57	12	2,6	3831112503953	52 763-125
40/50	G2	162	190	70	75	30	5,8	3831112504042	52 763-140
10-60 kPa									
15/20	G1	106	116	41	52	4	1,5	3831112505377	52 761-120
25/32	G1 1/4	125	150	51	57	12	2,6	3831112504134	52 761-125
40/50	G2	162	190	70	75	30	5,8	3831112504196	52 761-140
10-100 kPa									
15/20	G1	106	116	41	52	4	1,5	3831112504189	52 760-120
25/32	G1 1/4	125	150	51	57	12	2,6	3831112504004	52 760-125
40/50	G2	162	190	70	75	30	5,8	3831112504103	52 760-140
60-150 kPa									
15/20	G1	106	116	41	52	4	1,5	3831112504233	52 762-120
25/32	G1 1/4	125	150	51	57	12	2,6	3831112504141	52 762-125
40/50	G2	162	190	70	75	30	5,8	3831112504158	52 762-140

*) Length incl adjustment ring.

Kvs = m³/h at a pressure drop of 1 bar and fully open valve.

→ = Flow direction

DN 65-125

Flanges – Do not need any separate connections. Flanges according to EN-1092-2, type 21.

Included: Capillary pipe (Ø6) 2 x 1 500 mm and 2 capillary pipe connections R1/4 (M14x1 mounted on valve).

PN 25 (DN 65-80 also fit PN 16 flanges)

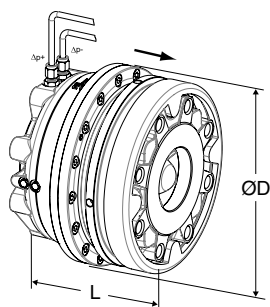

DN	D	L	Kvs	Kg	EAN	Article No
5-30 kPa						
65	210	160	60	18	3831112502635	52 763-165
80	210	160	60	18	3831112502819	52 763-180
100	320	254	150	58	3831112502406	52 763-190
125	320	254	150	58	3831112502444	52 763-191
10-60 kPa						
65	210	160	60	18	3831112504493	52 761-165
80	210	160	60	18	3831112504509	52 761-180
100	320	254	150	58	3831112502390	52 761-190
125	320	254	150	58	3831112502420	52 761-191
10-100 kPa						
65	210	160	60	18	3831112504677	52 760-165
80	210	160	60	18	3831112504684	52 760-180
100	320	254	150	58	3831112502161	52 760-190
125	320	254	150	58	3831112502413	52 760-191
60-150 kPa						
65	210	160	60	18	3831112504516	52 762-165
80	210	160	60	18	3831112504615	52 762-180
100	320	254	150	58	3831112505681	52 762-190
125	320	254	150	58	3831112505865	52 762-191

PN 16

DN	D	L	Kvs	Kg	EAN	Article No
5-30 kPa						
100	320	254	150	58	3831112502482	52 763-590
125	320	254	150	58	3831112502536	52 763-591
10-60 kPa						
100	320	254	150	58	3831112502468	52 761-590
125	320	254	150	58	3831112502512	52 761-591
10-100 kPa						
100	320	254	150	58	3831112502451	52 760-590
125	320	254	150	58	3831112502505	52 760-591
60-150 kPa						
100	320	254	150	58	3831112502499	52 762-590
125	320	254	150	58	3831112502543	52 762-591

Kvs = m³/h at a pressure drop of 1 bar and fully open valve.

→ = Flow direction

Connections for DN 15-50

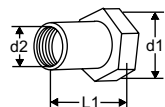

With female thread

Threads according to ISO 228.
Swivelling nut

d1	d2	L1*	EAN	Article No
G1	G1/2	26	3831112501027	52 759-015
G1	G3/4	32	3831112501034	52 759-020
G1 1/4	G1	47	3831112501041	52 759-025
G1 1/4	G1 1/4	52	3831112501058	52 759-032
G2	G1 1/2	52	3831112503489	52 759-040
G2	G2	64,5	3831112503205	52 759-050

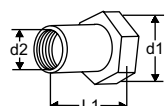

With female thread Rc

Threads according to ISO 7-1
Swivelling nut

d1	d2	L1*	EAN	Article No
G1	Rc1/2	26	3831112527454	52 751-301
G1	Rc3/4	32	3831112527461	52 751-302
G1 1/4	Rc1	47	3831112527478	52 751-303
G1 1/4	Rc1 1/4	52	3831112527485	52 751-304
G2	Rc1 1/2	52	3831112527492	52 751-305
G2	Rc2	64,5	3831112527508	52 751-306

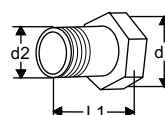

With male thread

Threads according to ISO 7
Swivelling nut

d1	d2	L1*	EAN	Article No
G1	R1/2	34	3831112500983	52 759-115
G1	R3/4	40	3831112500990	52 759-120
G1 1/4	R1	40	3831112501003	52 759-125
G1 1/4	R1 1/4	45	3831112501010	52 759-132
G2	R1 1/2	45	3831112503342	52 759-140
G2	R2	50	3831112503472	52 759-150

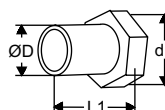

For welding

Swivelling nut

d1	D	L1*	EAN	Article No
G1	20,8	37	3831112500945	52 759-315
G1	26,3	42	3831112500952	52 759-320
G1 1/4	33,2	47	3831112500969	52 759-325
G1 1/4	40,9	47	3831112500976	52 759-332
G2	48,0	47	3831112501140	52 759-340
G2	60,0	52	3831112501294	52 759-350

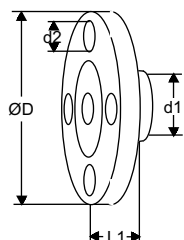

With flange

Attention! Can be used on the **inlet** side only.
Flange according to EN-1092-2:1997, type 16.

d1	d2	D	L1*	EAN	Article No
G1	M12	95	10	3831112501065	52 759-515
G1	M12	105	20	3831112501072	52 759-520
G1 1/4	M12	115	5	3831112504318	52 759-525
G1 1/4	M16	140	15	3831112501096	52 759-532
G2	M16	150	5	3831112504325	52 759-540
G2	M16	165	20	3831112501317	52 759-550

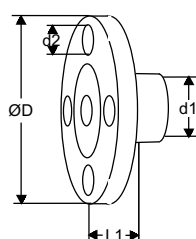

With flange (extended)

Attention! Must be used on the **outlet** side.
Flange according to EN-1092-2:1997, type 16.

d1	d2	D	L1*	EAN	Article No
G1	M12	95	47	3831112501157	52 759-615
G1	M12	105	47	3831112500136	52 759-620
G1 1/4	M12	115	62	3831112503533	52 759-625
G1 1/4	M16	140	62	3831112526129	52 759-632
G2	M16	150	72	3831112505025	52 759-640
G2	M16	165	72	3831112503892	52 759-650

*) Fitting length (from the gasket surface to the end of the connection).

Accessories

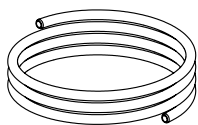

Capillary pipe

Ø6 mm.
2 pcs included in DAF 516.

L [m]	Ø	DN	EAN	Article No
1,2	6 mm	15-50	3831112527157	52 759-215
1,5	6 mm	65-125	3831112527164	52 759-265

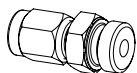

Capillary pipe connection

For capillary pipe Ø6 mm with R1/4, R1/8 and M14 connection.

DN 15-50: 2 pcs R1/4 included in DAF 516 (2 pcs R1/8 mounted on valve).

DN 65-125: 2 pcs R1/4 included in DAF 516 (2 pcs M14x1 mounted on valve).

	DN	EAN	Article No
6 x R1/4	15-125	3831112527355	52 759-201
6 x R1/8	15-32	3831112533868	52 759-213
6 x R1/8	40-50	3831112533875	52 759-218
6 x M14x1	65-125	3831112535145	52 759-214

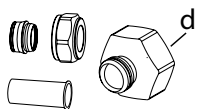

Connection set STAD

Must be used on STAD when connection of Ø6 mm capillary pipe.

2 transition nipples (G1/2 and G3/4), 1 thrust nut (Ø6), 1 cone (Ø6) and 1 support bush are included in DAF 516, DN 15-50.

d	EAN	Article No
G1/2	7318793850003	52 762-006
G3/4	7318793850102	52 762-106

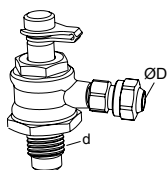

Capillary pipe connection with shut-off

For connection of Ø6 mm capillary pipe to STAF/STAF-SG.

d	D	For DN	EAN	Article No
G1/4	6	20-50	7318793999504	52 265-209
G3/8	6	65-400	7318793999405	52 265-208

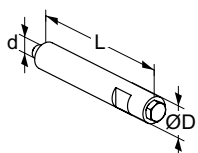

Venting extension

Suitable when insulation is used.
Stainless steel/EPDM/Brass.

d	D	L	EAN	Article No
M6	12	70	3831112531727	52 759-220

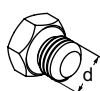

Venting screw

Brass/EPDM

d	EAN	Article No
M6	3831112527980	52 759-211

