

Data sheet

Pressure relief controller AFA / VFG 2(1) (PN 16, 25, 40)

Description



The controller is a self-acting pressure relief controller primarily for use in district heating systems. The controller is normally closed and opens on rising pressure.

The controller has a control valve, an actuator with one control diaphragm and a spring(s) for pressure setting.

Further on two valve versions are available:

- VFG 2 with metallic sealing cone
- VFG 21 with soft sealing cone

Main data:

- DN 15-250
- k_{vs} 4.0-400 m³/h
- PN 16, 25, 40
- Setting range:
 - 0.05-0.35 bar / 0.1-0.6 bar / 0.15-1.2 bar / 0.5-2.5 bar / 1-5 bar / 3-11 bar / 10-16 bar
- Temperature:
 - Circulation water / glycolic water up to 30 %: 2 ... 150 / 200 °C
- Connections:
 - Flange

Ordering

Example 1:
Pressure relief controller; DN 15;
 k_{vs} 4.0; metallic sealing; PN 16;
setting range 0.15-1.2 bar;
 T_{max} 150 °C; flange;

- 1x VFG 2 DN 15 valve
Code no: **065B2388**
- 1x AFA actuator
Code no: **003G1011**
- 1x Impulse tube set AF
Code no: **003G1391**

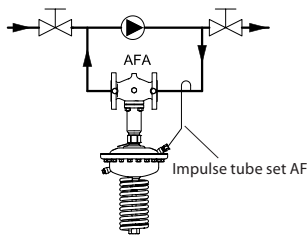

VFG 2 Valves (metallic sealing cone)

Picture	DN (mm)	k_{vs} (m ³ /h)	T_{max} (°C)	Code No.	T_{max} (°C)	Code No.	
				PN 16		PN 25	PN 40
	15	4.0	150	065B2388	200 ¹⁾	065B2401	065B2411
	20	6.3		065B2389		065B2402	065B2412
	25	8.0		065B2390		065B2403	065B2413
	32	16		065B2391		065B2404	065B2414
	40	20		065B2392		065B2405	065B2415
	50	32		065B2393		065B2406	065B2416
	65	50		065B2394		065B2407	065B2417
	80	80		065B2395		065B2408	065B2418
	100	125		065B2396		065B2409	065B2419
	125	160		065B2397		065B2410	065B2420
	150	280	150	065B2398	150	-	065B2421
	200	320		065B2399		-	065B2422
	250	400		065B2400		-	065B2423
	150	280		-	200 ¹⁾	-	On request
	200	320		-		-	On request
	250	400		-		-	On request

¹⁾ At temperatures above 150 °C only with seal pots (see Accessories)

Ordering (continuous)

Example 2:
Pressure relief controller; DN 15;
 k_{vs} 4.0; metallic sealing; PN 25;
setting range 0.15-1.2 bar;
 T_{max} 200 °C; flange;

- 1x VFG 2 DN 15 valve
Code no: **065B2401**
- 1x AFA actuator
Code no: **003G1011**
- 1x Impulse tube set AF
Code no: **003G1391**
- 1x Seal pot V1
Code no: **003G1392**

Products will be delivered separately.

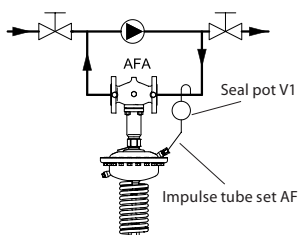

VFG 21 Valves (soft sealing cone)

Picture	DN (mm)	k_{vs} (m ³ /h)	T_{max} (°C)	Connections	Code No.
					PN 16
	15	4.0	150	Flanges acc, to EN 1092-1	065B2502
	20	6.3			065B2503
	25	8.0			065B2504
	32	16			065B2505
	40	20			065B2506
	50	32			065B2507
	65	50			065B2508
	80	80			065B2509
	100	125			065B2510
	125	160			065B2511
	150	280			065B2512
	200	320			065B2513
	250	400			065B2514

Note: other valves available on special request,

AFA Actuators

Picture	Pressure setting range (bar)	for DN	Code No.
	10-16	15-125	003G1007
	3-11		003G1008
	1-5		003G1009
	0.5-2.5		003G1010
	0.15-1.2	15-250	003G1011
	0.1-0.6		003G1012
	0.05-0.35		003G1013

Accessories

Picture	Type designation	Description	Connections	Code No.
	Impulse tube set AF	- 1x Copper tube Ø10 x 1 x 1500 mm - 1 x compression fitting for imp, tube connection to pipe (G 1/4) - 2 x socket	-	003G1391
	Seal pot V1 ¹⁾	Capacity 1 liter; with compression fittings for imp, tube Ø10	-	003G1392
	Seal pot V2 ¹⁾	Capacity 3 liter; with compression fittings for imp, tube Ø10, for actuator size 630 cm ²	-	003G1403
	Compression fitting ²⁾	For impulse tube Ø10 connections to controller	G 1/4	003G1468
	Shut off valve	For impulse tube Ø10	-	003G1401
	Throttle valve			065B2909

¹⁾ Seal pot has to be used on impulse tubes always when $T_{max} \geq 150$ °C

²⁾ Consist of a nipple, compression ring and nut

Ordering (continuous)

Service kits

Picture	Type designation	DN (mm)	k _{vs} (m ³ /h)	Code No.	
				for VFG 2	for VFG 21
	Valve insert	15	4.0	065B2796	065B2790
		20	6.3	065B2797	065B2791
		25	8	065B2798	065B2792
		32	16		
		40	20	065B2799	065B2793
		50	32		
		65	50	065B2800	065B2794
		80	80		
		100	125	065B2801	065B2795
		125	160		
		150	280	065B2964	065B2966
250	400	065B2965	-		
	Stuffing cone (with EPDM O-rings)			003G1464	

Technical data

Valve

Nominal diameter	DN	15	20	25	32	40	50	65	80	100	125	150	200	250
k _{vs} value	m ³ /h	4.0	6.3	8.0	16	20	32	50	80	125	160	280	320	400
Cavitation factor z		0.6	0.6	0.6	0.55	0.55	0.5	0.5	0.45	0.4	0.35	0.3	0.2	0.2
Leakage acc. to standard IEC 534 (% of k _{vs})	VFG 2	≤ 0.03										≤ 0.05		
	VFG 21	≤ 0.01												
Nominal pressure	PN	16, 25, 40												
Max. differential pressure	PN 16	16								15	12	10		
	PN 25, 40	20												
Media		Circulation water / glycolic water up to 30 %												
Media pH		Min. 7, max. 10												
Media temperature	VFG 2	2 ... 150 / 2 ... 200 ¹⁾										2 ... 150 (200 ²⁾)		
	VFG 21	2 ... 150												
Connections		Flange												
Materials														
Valve body	PN 16	Grey cast iron EN-GJL-250 (GG-25)												
	PN 25	Ductile iron EN-GJS-400(GGG-40.3)												
	PN 40	Cast steel GP240GH (GS-C 25)												
Valve seat		Stainless steel, mat. No. 1.4021										Stainless steel, mat. No. 1.4313		
Valve cone		Stainless steel, mat. No. 1.4404										Stainless steel, mat. No. 1.4021		
Sealing	VFG 2	Metal												
	VFG 21	EPDM												
Pressure relieve system		Bellows (Stainless steel, mat. No. 1.4571)										Diaphragm (EPDM)		

¹⁾ At temperatures above 150 °C only with seal pots (see Accessories)

²⁾ On request

Actuator

Actuator size	cm ²	32			80			250			630			
Max. operating pressure	bar	25												
Pressure setting ranges and spring colours	bar	black	silver	silver	yellow	silver	yellow	yellow	yellow	yellow	yellow	yellow	yellow	
		10 – 16	3 – 11	1 – 5	0.5-2.5	0.15-1.2	0.1 – 0.6	0.05 – 0.35						
Materials														
Actuator housing		Steel, mat. No. 1.0338, zinc plated												
Control diaphragm		EPDM (Rolling; fibre enforced)												

Application principles

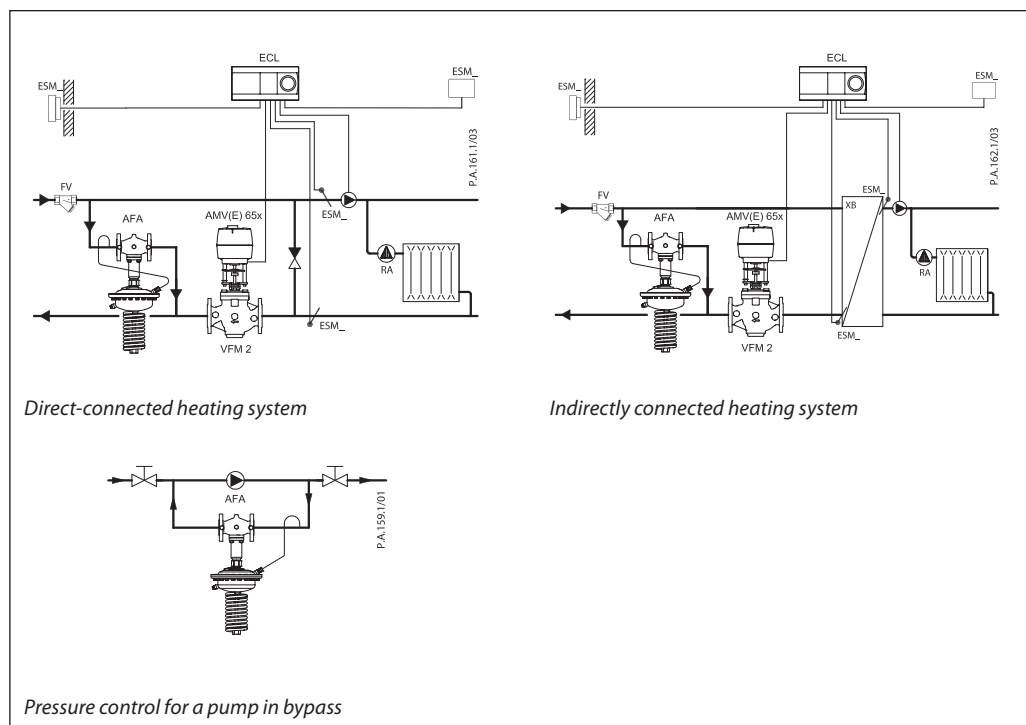

Installation position

DN 15-80 $T_{max} \leq 120\text{ }^{\circ}\text{C}$

The controllers can be installed in any position.

DN 15-80 $T_{max} > 120\text{ }^{\circ}\text{C}$; DN 100-250

The controllers can be installed in horizontal pipes only, with a pressure actuator oriented downwards.

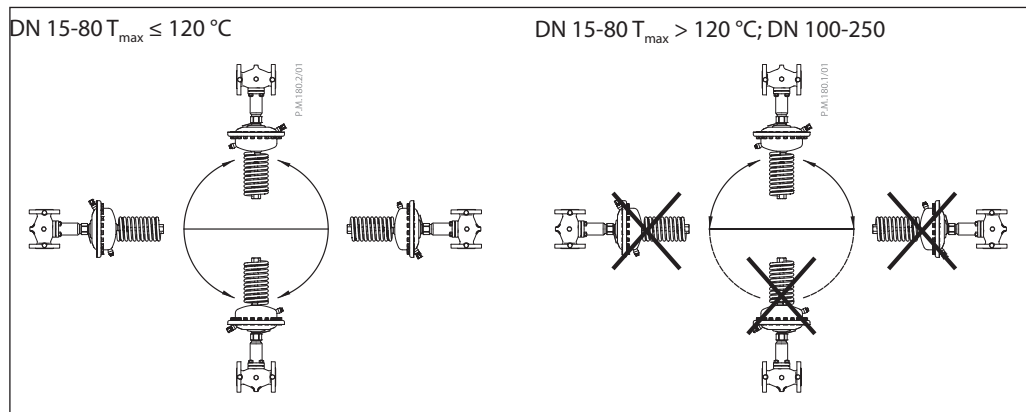

Pressure temperature diagram

Working area is below P-T line and it ends at Tmax for each valve

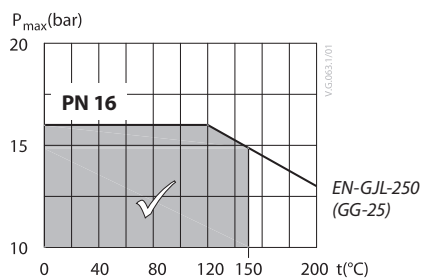

Maximum allowed operating pressure as a function of media temperature (according to EN 1092-2)

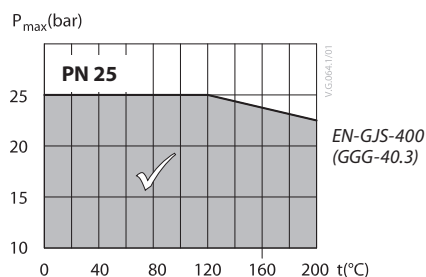

Maximum allowed operating pressure as a function of media temperature (according to EN 1092-2)

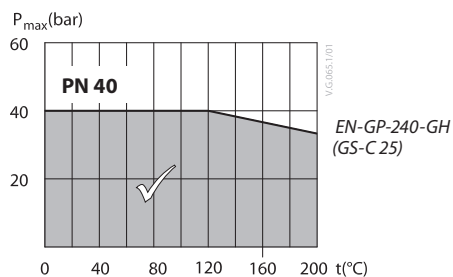

Maximum allowed operating pressure as a function of media temperature (according to EN 1092-1)

Sizing

Given data:

$$Q_{\max} = 4.0 \text{ m}^3/\text{h}$$

$$\Delta p_{\min} = 1.3 \text{ bar}$$

Nominal pressure PN 25

Solution:

The example selects AFA VFG 2 DN 15, k_{vS} value 4.0, with pressure setting range 0.5-2.5 bar.

k_v value is calculated according to formula:

$$k_v = \frac{Q_{\max}}{\sqrt{\Delta p_{\min}}} = \frac{4.0}{\sqrt{1.3}}$$

$$k_v = 3.5 \text{ m}^3/\text{h}$$

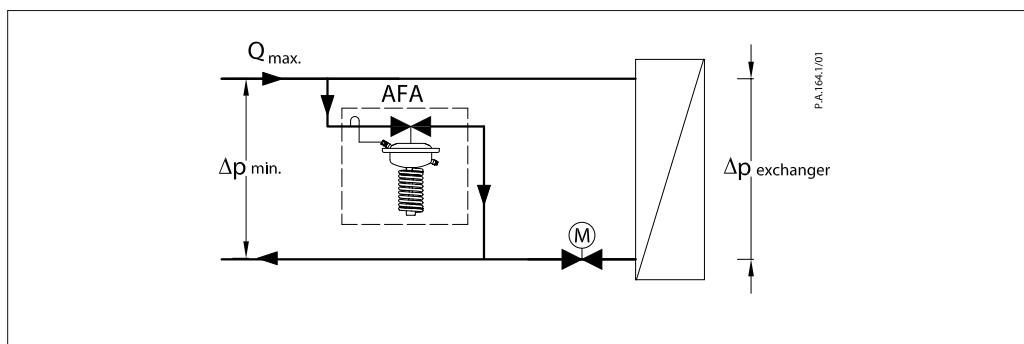
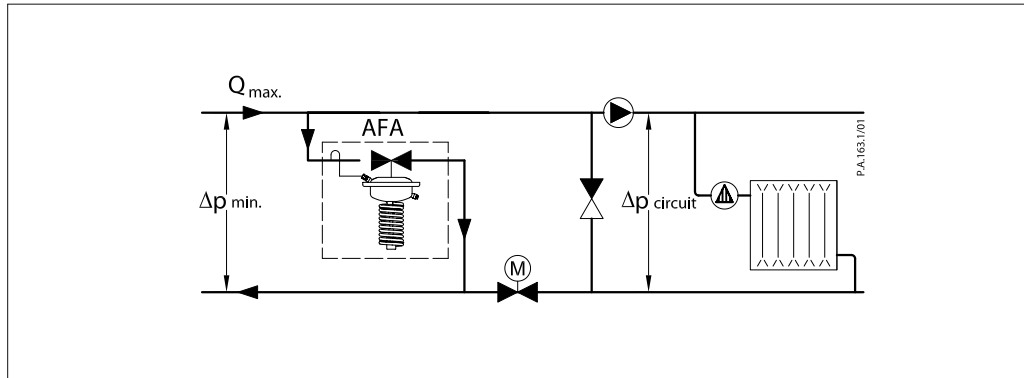

Design

1. Valve body
2. Cover
3. Valve seat
4. Valve insert
5. Pressure relieved valve cone
6. Valve stem
7. Bellows for pressure relief of valve cone
8. Actuator
9. Diaphragm for pressure relief of valve cone
10. Control diaphragm for pressure control
11. Setting spring for pressure control
12. Adjuster for pressure setting, prepared for sealing
13. Stuffing cone
14. Union nut
15. Compression fitting for impulse tube
16. Upper casing of diaphragm
17. Lower casing of diaphragm
18. Valve body extension
19. Shut off valve for water filling
20. Closing plug
21. Air space bore

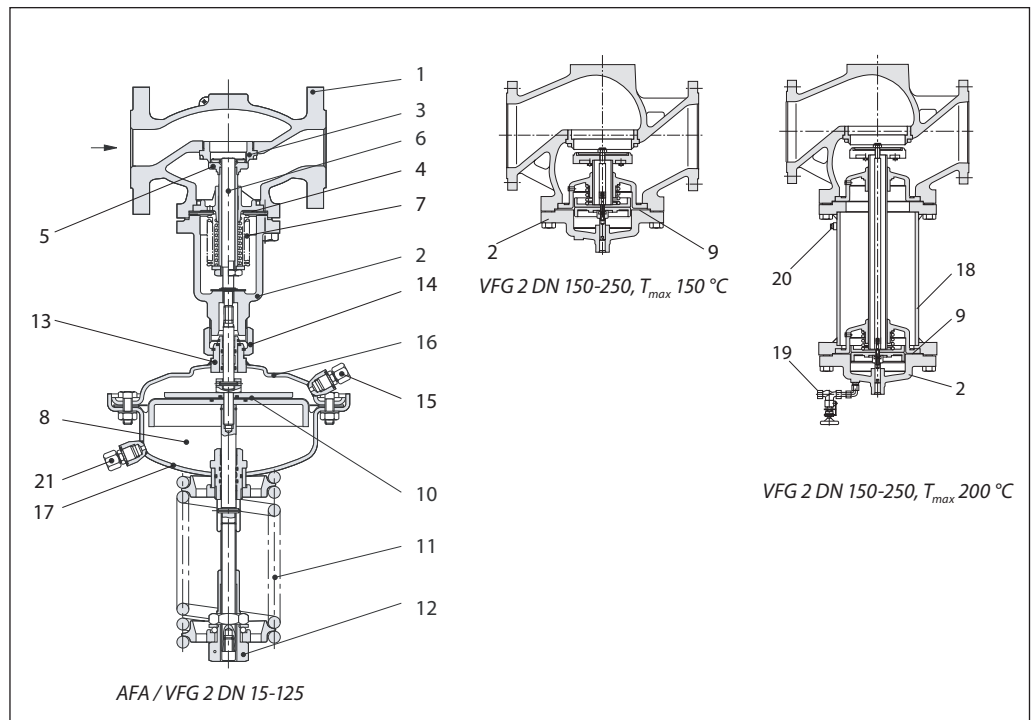

Function

The pressure in front of the control valve is being transferred through the impulse tube to the actuator chamber and act on control diaphragm for pressure control. On the other side of the diaphragm atmospheric pressure is acting (through air space bore). Control valve is normally closed. It opens on rising pressure and closes on falling pressure to maintain constant pressure.

Settings

Pressure setting
 Pressure setting is being done by the adjustment of the setting spring for pressure control. The adjustment can be done by means of spring for pressure setting and pressure indicators.

Data sheet

Pressure relief controller AFA/VFG 2(1) (PN 16, 25, 40)

Dimensions

VFG DN 15-125 VFG DN 150-250 VFG DN 150-250 with valve body extension up to 200 °C

VFG 2, VFG 21 Valves

DN		15	20	25	32	40	50	65	80	100	125	150	200	250	
L		130	150	160	180	200	230	290	310	350	400	480	600	730	
B		213	213	239	239	241	241	276	276	381	381	326	354	401	
H		267	267	304	304	323	323	370	370	505	505	505	591	661	
Weight	PN 16 / 25	7.5	8.5	10	12	15	18	27.5	30	58	68	115	185	323	
	PN 40							30	32.5	60.5	69	141	253	333	
B _i													620	852	1199
H _i													799	1089	1459
Weight (valve with body extension)	PN 16 / 25												154	301	469
	PN 40												179	336	505

AFA Actuator

Actuator size	cm ²	32	80	250	630
A	mm	172	172	263	380
H	mm	425	420	430	505
Weight	kg	7.5	7.5	13	28

Seal pot V1 Seal pot V2

Shut off valve Compression fitting

Danfoss A/S

Heating Segment • heating.danfoss.com • +45 7488 2222 • E-Mail: heating@danfoss.com

Danfoss can accept no responsibility for possible errors in catalogues, brochures and other printed material. Danfoss reserves the right to alter its products without notice. This also applies to products already on order provided that such alterations can be made without consequential changes being necessary in specifications already agreed. All trademarks in this material are property of the respective companies. Danfoss and all Danfoss logotypes are trademarks of Danfoss A/S. All rights reserved.