

Operating Guide

VZ 2, VZ 3, VZ 4 DN 15-20

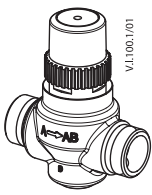

MAINTENANCE
FREE



VZ2

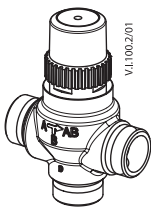

VZ3

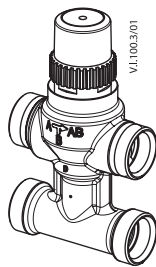

VZ4

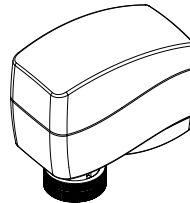

AMV(E) 130, 140

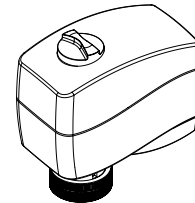

AMV(E) 130H, 140H

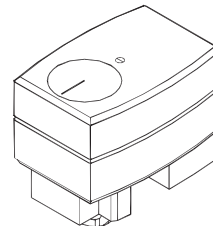
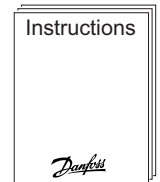

AMV(E) 13 (SU)

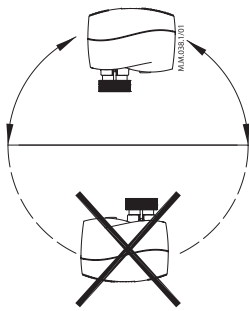

IP 42
AMV(E) 130/140

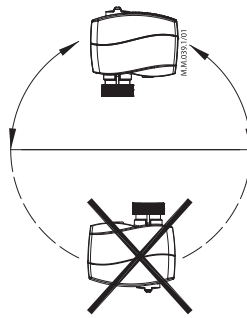

IP 42
AMV(E) 130H/140H

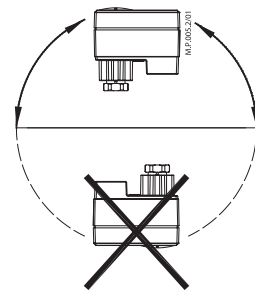

IP 54
AMV(E) 13 (SU)

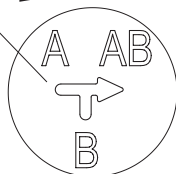
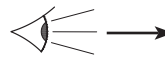
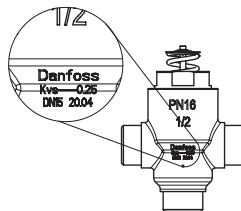
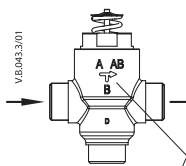
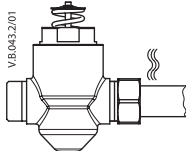

VZ 2, VZ 3, VZ 4

DN	Max. Δp (bar)
15	3,5
20	2,5

max. t: 120°C
min. t: 2°C

max. P: 16bar

16 bar = 1600 kPa = 232 psi

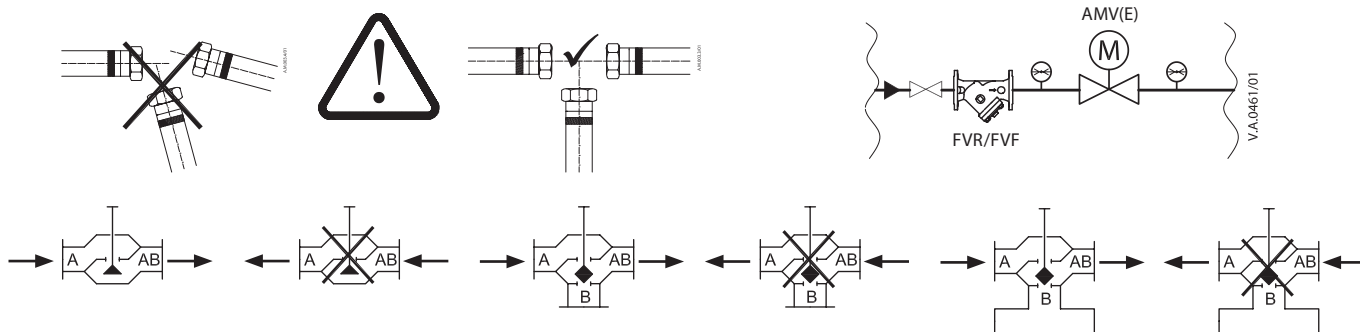
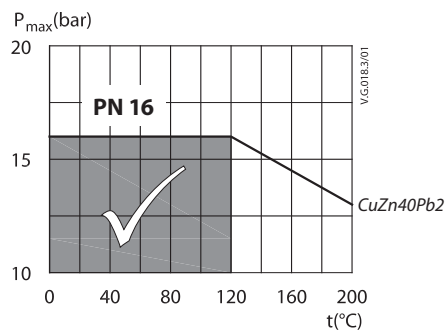

AMV(E) 130(H), 140(H) + VZ

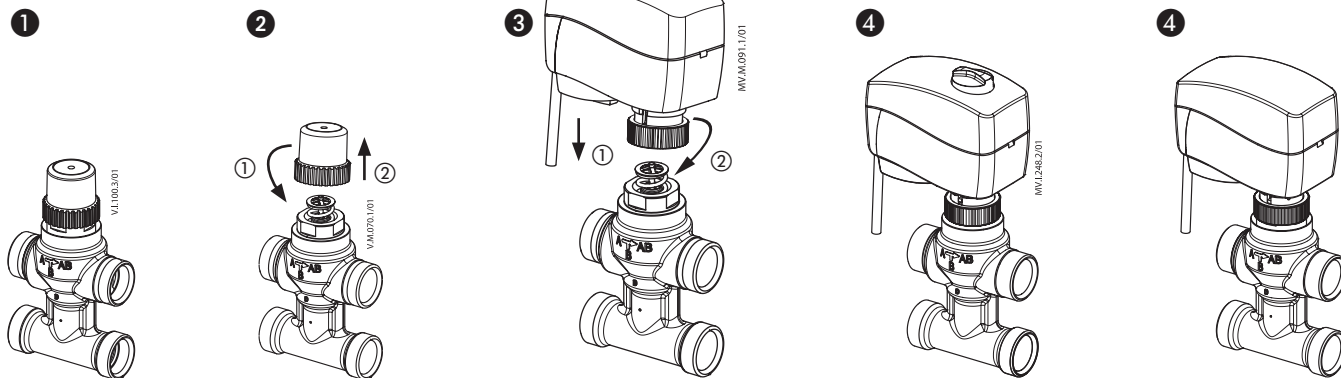

AMV(E) 13 SU + VZ

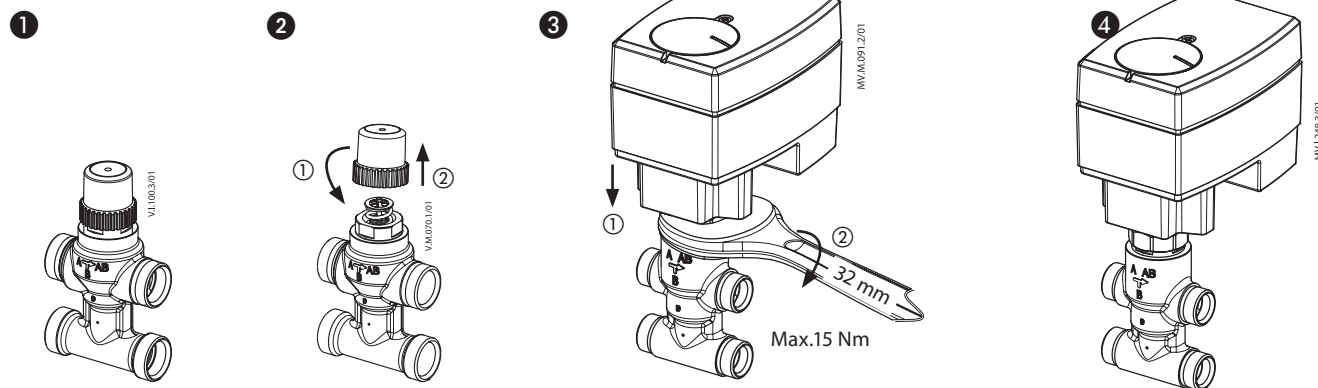

VZ 2, VZ 3, VZ 4

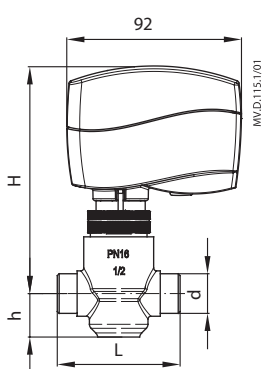

AMV(E) 130/140 + VZ 2

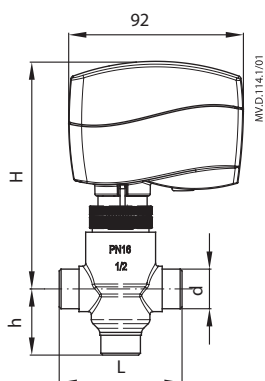

AMV(E) 130/140 + VZ 3

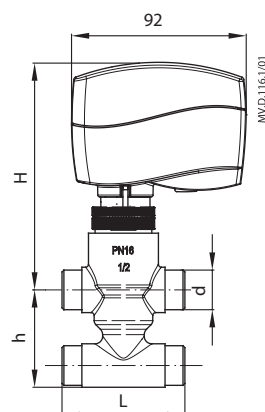

AMV(E) 130/140 + VZ 4

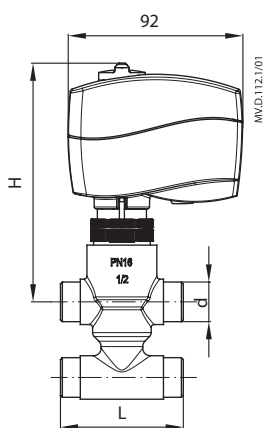
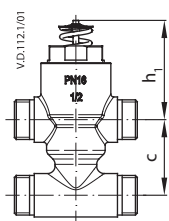

AMV(E) 130H/140H + VZ .

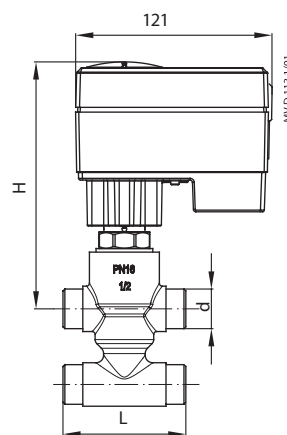

AMV(E) 13 SU + VZ .

Valve type	d	L (mm)	H (mm)			h	h ₁	c	Valve weight (kg)
			AMV(E) 13 SU	AMV(E) 130/140	AMV(E) 130H/140H				
VZ 2 / DN 15	G 1/2"	65	155	119	125	26,5	52,5	-	0,38
VZ 2 / DN 20*	G 3/4"	77							0,49
VZ 3 / DN 15	G 1/2"	65							0,39
VZ 3 / DN 20*	G 3/4"	77				0,50			
VZ 4 / DN 15	G 1/2"	65				40			0,51
VZ 4 / DN 20*	G 3/4"	77							50

* conex valves DN 20 - G 1 1/8" 14 TPI

Tailpieces for soldering

G	Ød	L	Weight (kg)
	mm		
1/2"	12	15	0,11
3/4"	15	20	0,17

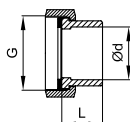

Tailpieces with external thread

G	R	L (mm)	Weight (kg)
	(")		
1/2"	3/8	23	0,11
3/4"	1/2	26	0,17

