

STAD-C

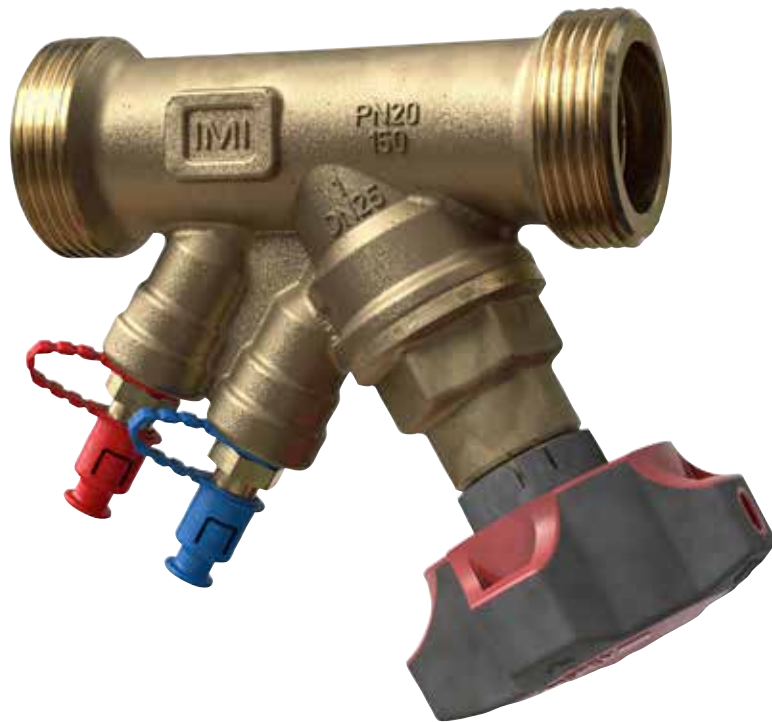

Balancing valves

DN 15-50 with double secured measuring points

STAD-C

The STAD-C balancing valve has been specially developed for use in indirect cooling systems but performs just as effectively in refrigerated counters and cold-storage rooms. Whatever the application, the STAD-C delivers unrivalled hydronic performance.

Key features

> Handwheel

Equipped with a digital read-out, the handwheel ensures accurate and straightforward balancing. Positive shut-off function for easy maintenance.

> Self-sealing measuring points

Doubly secured and self-sealing for total protection against leakage. Also enable more straightforward maintenance.

> AMETAL®

Dezincification resistant alloy that guarantees a longer valve lifetime and lowers the risk of leakage.



Technical description

Application:

Heating and cooling systems
Tap water systems

Functions:

Balancing
Pre-setting
Measuring
Shut-off

Dimensions:

DN 15-50

Pressure class:

PN 20

Temperature:

Max. working temperature: 150°C
(At temperatures higher than 120°C, the handwheel should be removed.)
Min. working temperature: -20°C

Media:

Water or neutral fluids, water-glycol mixtures (0-57%).

Material:

Valve body and bonnet: AMETAL®
Sealing (body/bonnet): EPDM O-ring
Valve plug: AMETAL®
Seat seal: EPDM O-ring
Spindle: AMETAL®
Slip washer: PTFE
Spindle seal: EPDM O-ring
Spring: Stainless steel
Handwheel: Polyamide and TPE

Measuring points: AMETAL®
Sealings: EPDM
Caps: Polyamide and TPE

AMETAL® is the dezincification resistant alloy of IMI Hydronic Engineering.

Marking:

Body: IMI or TA, PN 20/150, DN and inch size.
Handwheel: TA, valve type and DN.

Connection:

- Male thread according to ISO 228.
Thread length according to DIN 3546.
- Soldering ends

Measuring points

The measuring points on STAD-C are self-sealed and double-secured. Connect the measuring hoses directly on the measuring points, then open the measuring points by using a

wrench. Close the measuring points before disconnecting the measuring hoses.

Sizing

When Δp and the design flow are known, use the formula to calculate the Kv value or use the diagram.

$$Kv = 0,01 \frac{q}{\sqrt{\Delta p}} \quad q \text{ l/h, } \Delta p \text{ kPa}$$

$$Kv = 36 \frac{q}{\sqrt{\Delta p}} \quad q \text{ l/s, } \Delta p \text{ kPa}$$

Kv values

Turns	DN 15/14	DN 20	DN 25	DN 32	DN 40	DN 50
0.5	0.127	0.511	0.60	1.14	1.75	2.56
1	0.212	0.757	1.03	1.90	3.30	4.20
1.5	0.314	1.19	2.10	3.10	4.60	7.20
2	0.571	1.90	3.62	4.66	6.10	11.7
2.5	0.877	2.80	5.30	7.10	8.80	16.2
3	1.38	3.87	6.90	9.50	12.6	21.5
3.5	1.98	4.75	8.00	11.8	16.0	26.5
4	2.52	5.70	8.70	14.2	19.2	33.0

Measuring accuracy

The handwheel zero position is calibrated and must not be changed.

Deviation of flow at different settings

The curve (Fig. 1) is valid for valves with normal pipe fittings (Fig. 2). Try also to avoid mounting taps and pumps, immediately before the valve.

The valve can be installed with the opposite flow direction. The specified flow details are also valid for this direction although tolerances can be greater (maximum 5% more).

Fig. 1

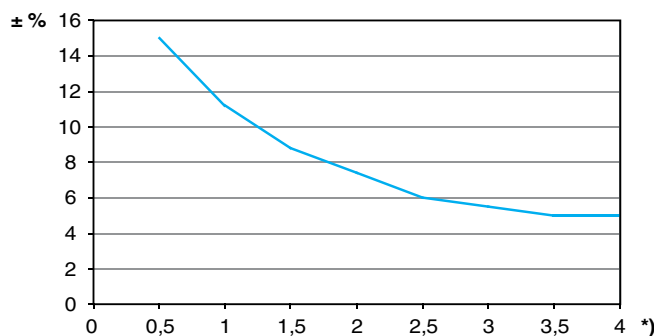

*) Setting, No. of turns.

Fig. 2

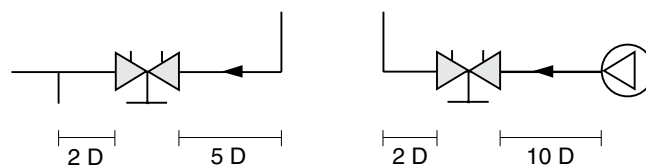

D = Valve DN

Correction factors

The flow calculations are valid for water (+20°C). For other liquids with approximately the same viscosity as water (≤ 20 cSt = $3^\circ\text{E}=100\text{S.U.}$), it is only necessary to compensate for the specific density. However, at low temperatures, the viscosity increases and laminar flow may occur in the valves. This causes

a flow deviation that increases with small valves, low settings and low differential pressures. Correction for this deviation can be made with the software HySelect or directly in our balancing instruments.

Setting

Setting of a valve for a particular pressure drop, e.g. corresponding to 2.3 turns on the graph, is carried out as follows:

1. Close the valve fully (Fig. 1).
2. Open the valve 2.3 turns (Fig. 2).
3. Using a 3 mm Allen key, turn the inner spindle clockwise until stop.
4. The valve is now set.

To check the setting: Close the valve, the indicator shows 0.0. Open it to the stop position. The indicator then shows the set value, in this case 2.3 (Fig. 2).

Diagrams showing the pressure drop for each valve size at different settings and flow rates are available to help determine the correct valve size and pre-setting (pressure drop).

Four turns corresponds to fully open valve (Fig. 3). Opening it further will not increase the capacity.

Fig. 1
Valve closed

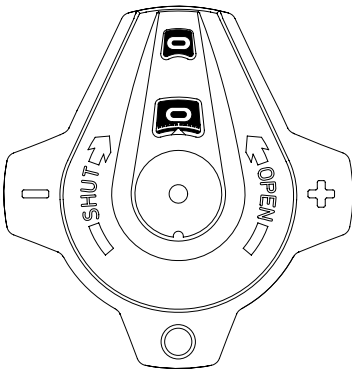

Fig. 2
The valve is set at 2.3

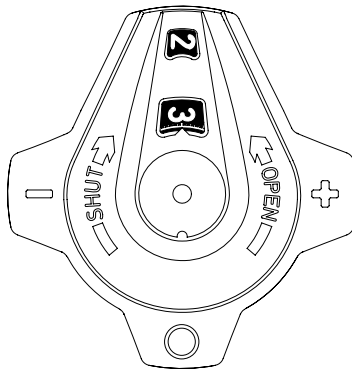

Fig. 3
Fully open valve

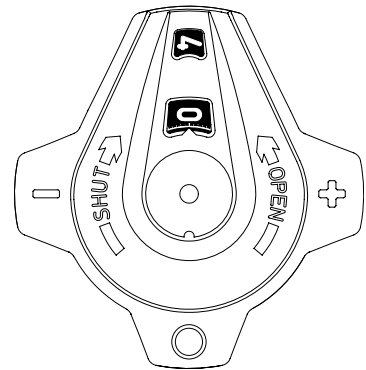

Diagram example

Wanted:

Presetting for DN 25 at a desired flow rate of 1,6 m³/h and a pressure drop of 10 kPa.

Solution:

Draw a straight line joining 1,6 m³/h and 10 kPa. This gives Kv=5. Now draw a horizontal line from Kv=5. This intersects the bar for DN 25 which gives 2,42 turns.

NOTE:

If the flow rate is out of the scale in the diagram, the reading can be made as follows:

Starting with the example above, we get 10 kPa, Kv=5 and flow-rate 1.6 m³/h.

At 10 kPa and Kv=0.5 we get the flow-rate 0.16 m³/h, and at Kv=50, we get 16 m³/h. That is, for a given pressure drop, it is possible to read 10 times or 0.1 times the flow and Kv-values.

Diagram

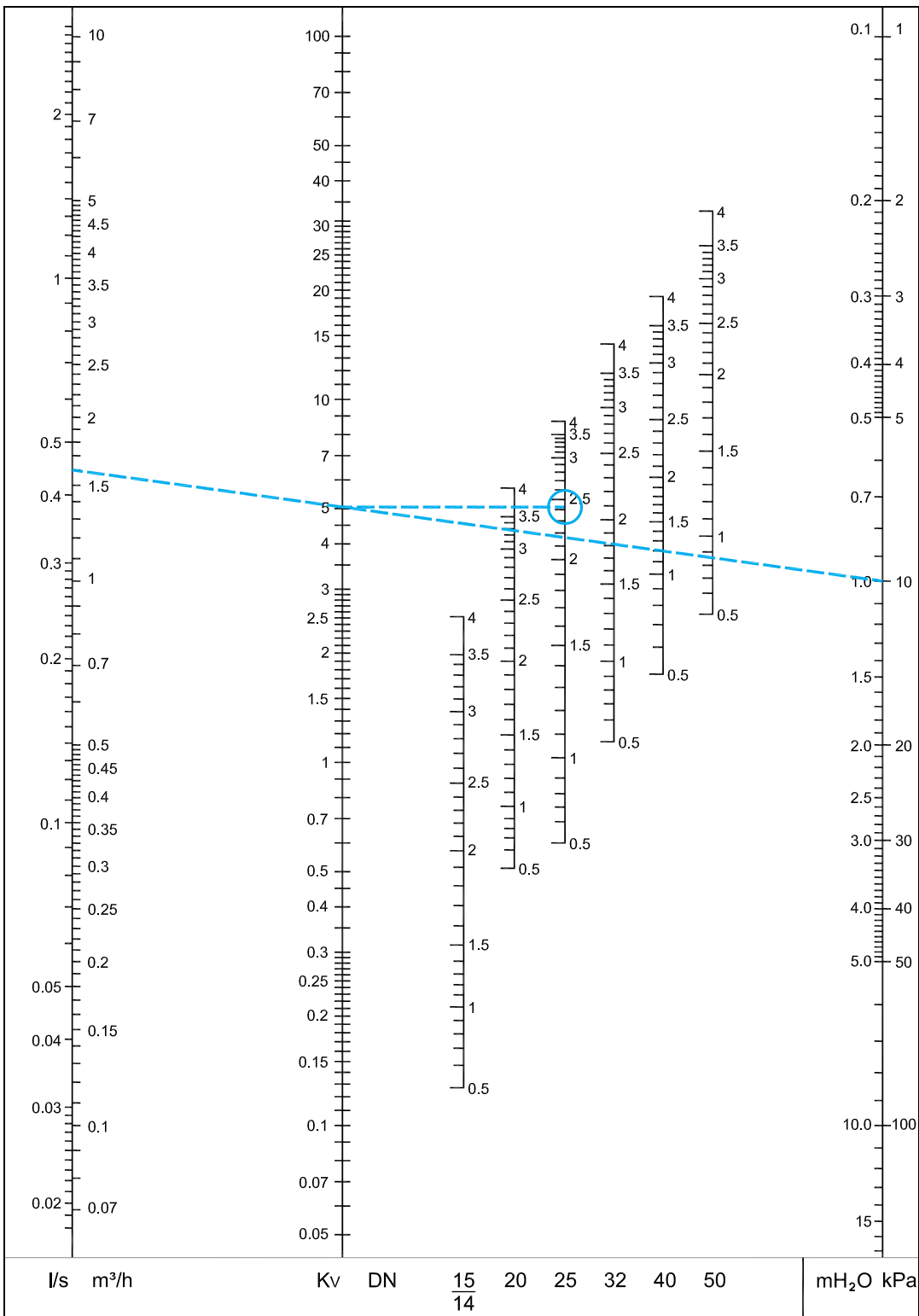

Articles

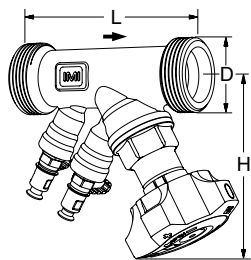

Male thread

Thread according to ISO 228. Thread length according to DIN 3546.

DN	D	L	H	Kvs	Kg	EAN	Article No
15/14	G3/4	97	100	2,52	0,62	7318793780409	52 156-014
20	G1	110	100	5,70	0,72	7318793780508	52 156-020
25	G1 1/4	115	105	8,70	0,88	7318793780607	52 156-025
32	G1 1/2	134	110	14,2	1,2	7318793780706	52 156-032
40	G2	150	120	19,2	1,6	7318793780805	52 156-040
50	G2 1/2	168	120	33,0	2,3	7318793780904	52 156-050

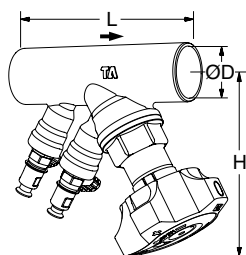

Soldering ends

DN	D	L	H	Kvs	Kg	EAN	Article No
15/14	15	90	100	2,52	0,62	7318793779809	52 153-014
20	22	97	100	5,70	0,68	7318793779908	52 153-020
25	28	110	105	8,70	0,80	7318793780003	52 153-025
32	35	124	110	14,2	1,2	7318793780102	52 153-032
40	42	130	120	19,2	1,5	7318793780201	52 153-040
50	54	155	120	33,0	2,3	7318793780300	52 153-050

→ = Flow direction

Kvs = m³/h at a pressure drop of 1 bar and fully open valve.

Accessories

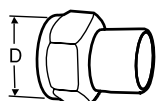

Welding connection

Swivelling nut
Max 150°C
Brass/Steel 1.0045 (EN 10025-2)

Valve DN	D	Pipe DN	EAN	Article No
10	G1/2	10	7318792748400	52 009-010
15	G3/4	15	7318792748509	52 009-015
20	G1	20	7318792748608	52 009-020
25	G1 1/4	25	7318792748707	52 009-025
32	G1 1/2	32	7318792748806	52 009-032
40	G2	40	7318792748905	52 009-040
50	G2 1/2	50	7318792749001	52 009-050

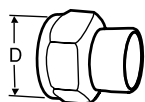

Soldering connection

Swivelling nut
Max 150°C
Brass/gunmetal CC491K (EN 1982)

Valve DN	D	Pipe Ø	EAN	Article No
10	G1/2	10	7318792749100	52 009-510
10	G1/2	12	7318792749209	52 009-512
15	G3/4	15	7318792749308	52 009-515
15	G3/4	16	7318792749407	52 009-516
20	G1	18	7318792749506	52 009-518
20	G1	22	7318792749605	52 009-522
25	G1 1/4	28	7318792749704	52 009-528
32	G1 1/2	35	7318792749803	52 009-535
40	G2	42	7318792749902	52 009-542
50	G2 1/2	54	7318792750007	52 009-554

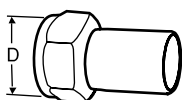

Connection with smooth end

For connection with press coupling
Swivelling nut
Max 150°C
Brass/AMETAL®

Valve DN	D	Pipe Ø	EAN	Article No
10	G1/2	12	7318793810502	52 009-312
15	G3/4	15	7318793810601	52 009-315
20	G1	18	7318793810700	52 009-318
20	G1	22	7318793810809	52 009-322
25	G1 1/4	28	7318793810908	52 009-328
32	G1 1/2	35	7318793811004	52 009-335
40	G2	42	7318793811103	52 009-342
50	G2 1/2	54	7318793811202	52 009-354

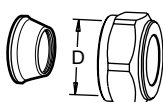

Compression connection

Max 100°C
Support bushes shall be used, for more information see catalogue leaflet FPL.
Should not be used with PEX pipes.
Brass/AMETAL®
Chrome plated

Valve DN	D	Pipe Ø	EAN	Article No
10	G1/2	8	7318793620002	53 319-208
10	G1/2	10	7318793620101	53 319-210
10	G1/2	12	7318793620200	53 319-212
10	G1/2	15	7318793620309	53 319-215
10	G1/2	16	7318793620408	53 319-216
15	G3/4	15	7318793705006	53 319-615
15	G3/4	18	7318793705105	53 319-618
15	G3/4	22	7318793705204	53 319-622

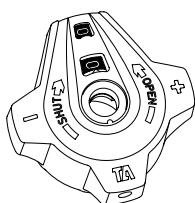

Handwheel

Complete

EAN	Article No
7318794043503	52 186-007

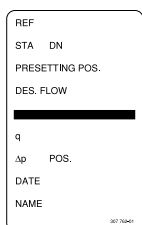

Identification tag

EAN	Article No
7318792779206	52 161-990



Allen key

[mm]		EAN	Article No
3	Pre-setting	7318792836008	52 187-103

