

HERZ STRÖMAX GM/GML/GR

STRÖMAX-GM/GML commissioning valve with test points

STRÖMAX-GR commissioning valve

Data sheet STRÖMAX GM/GML/GR, Issue 1220

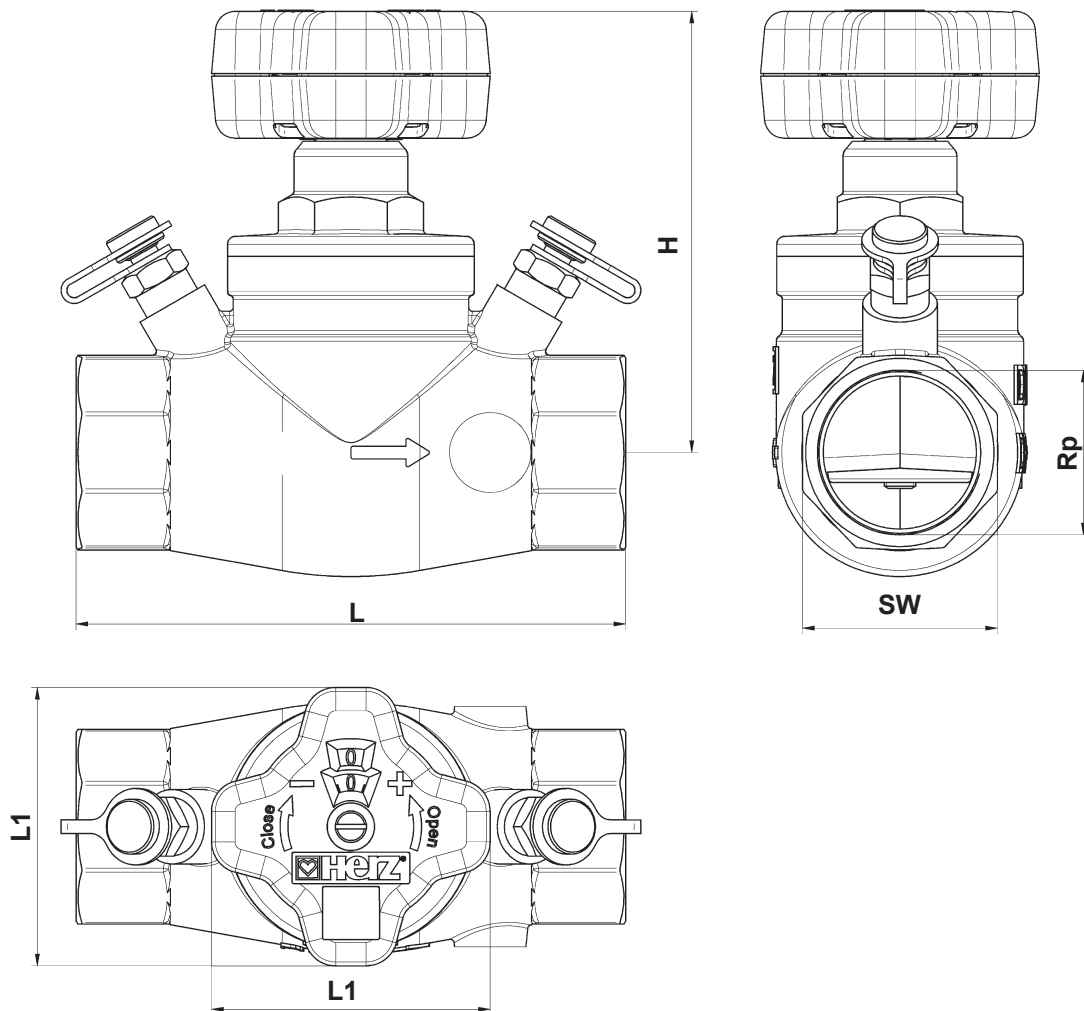

Dimensions in mm

Fig. Number		DN	Rp	L	L1	H	SW Hexagon	SW Octagon	Weight, kg		kvs
4217 GM	4217 GR								4217 GM	4217 GR	
1 4217 30		15 LF	1/2	100	71	97	27	-	0,86		0,93
1 4217 31		15 MF	1/2	100	71	97	27	-	0,89		3,49
1 4217 01	1 4217 61	15	1/2	100	71	97	27	-	0,85	0,82	6,05
1 4217 32	1 4217 62	20	3/4	100	71	97	32	-	1,22	0,83	6,11
1 4217 33	1 4217 63	25	1	120	71	107	41	-	1,55	1,3	9,22
1 4217 34	1 4217 64	32	1¼	140	71	112	-	50	1,88	1,84	18,83
1 4217 35	1 4217 65	40	1½	150	71	112	-	55	2,34	2,21	23,29
1 4217 36	1 4217 66	50	2	165	110	136	-	70	3,74	3,73	35,26
1 4217 07	1 4217 67	65	2½	190	110	141	-	85	5,23	5,22	52,11
1 4217 08	1 4217 68	80	3	210	110	142	-	100	6,97	7,03	76,10

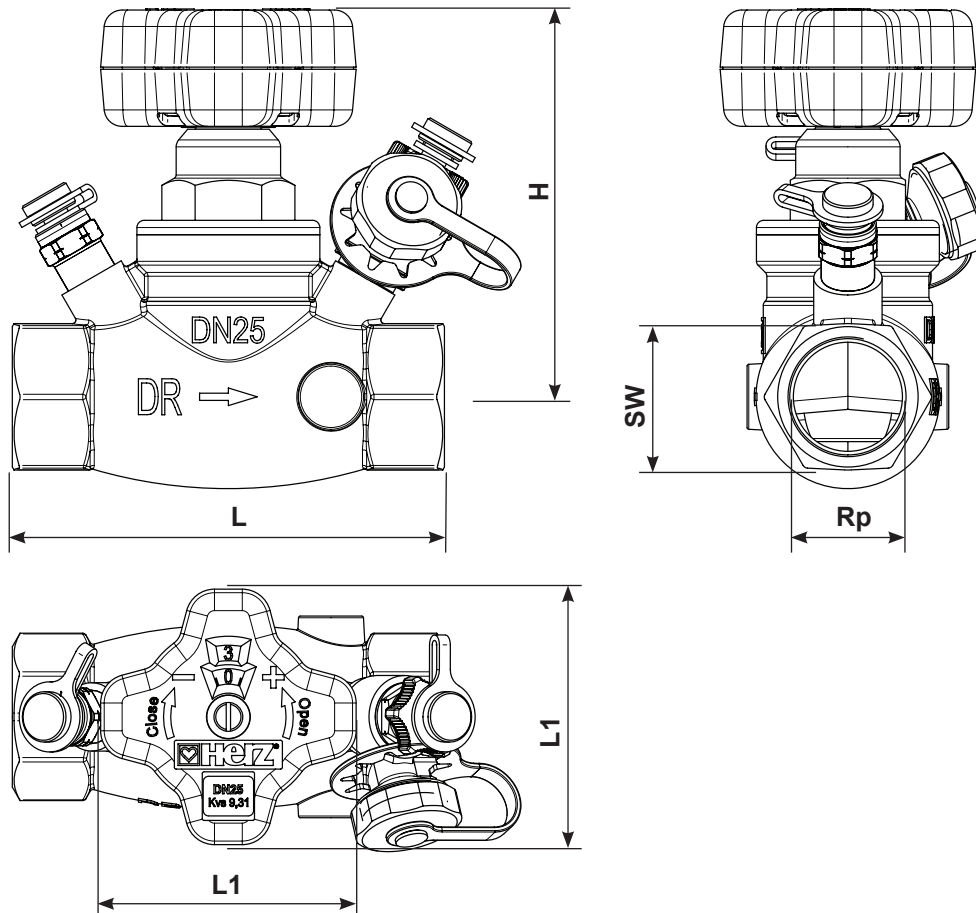

Dimensions in mm

Fig. Number	DN	Rp	L	L1	H	SW Hexagon	SW Octagon	Weight, kg	kvs
4217 GML									
1 4217 10	15 LF	1/2	100	71	97	27	-	0,98	0,93
1 4217 19	15 MF	1/2	100	71	97	27	-	0,97	3,49
1 4217 11	15	1/2	100	71	97	27	-	0,97	6,05
1 4217 12	20	3/4	100	71	97	32	-	1,00	6,11
1 4217 13	25	1	120	71	107	41	-	1,45	9,22
1 4217 14	32	1¼	140	71	112	-	50	1,98	18,83
1 4217 15	40	1½	150	71	112	-	55	2,34	23,29
1 4217 16	50	2	165	110	136	-	70	3,85	35,26
1 4217 17	65	2½	190	110	141	-	85	5,35	52,11
1 4217 18	80	3	210	110	142	-	100	7,20	76,10

☑ Models

STRÖMAX-GM commissioning valve with test points, 1/2" – 3"

Screw down model, brass version, socket x socket, non-rising spindle, spindle seal by means of double-O-ring, presetting by limitation of valve lift by means of internal spindle; digital display of presetting step at the hand wheel window.

2 standard test points are located adjacent to the hand wheel.

STRÖMAX-GML commissioning valve with test points and capillary connection 1/2" – 3"

Screw down model, brass version, socket x socket, non-rising spindle, spindle seal by means of double-O-ring, presetting by limitation of valve lift by means of internal spindle; digital display of presetting step at the hand wheel window.

One standard test point and one test point fitted with a capillary connection are located adjacent to the hand wheel.

STRÖMAX-GR commissioning valve, 1/2" – 3"

Screw down model, brass version, socket x socket, non-rising spindle, spindle seal by means of double-O-ring, presetting by limitation of valve lift by means of internal spindle; digital display of presetting step at the hand wheel window.

☑ Other Models

4117 M	DN 15 - 80	Strömax-M, Double Regulating Valves, inclined model with test points
4117 R	DN 15 - 80	Strömax-R, Double Regulating Valves, inclined model
4117 MW	DN 15 - 50	Strömax-MW, Double Regulating Valves for drinking water, inclined model with test points
		Strömax-MW, Double Regulating Valves for drinking water, inclined model with test points
4117 RW	DN 15 - 50	Strömax-RW, Double Regulating Valves for drinking water, inclined model
4017 M	DN 15 - 50	4017-M Double Regulating Valves with integral fixed orifice, inclined model with test points
4017 R	DN 15 - 50	4017-R 4017-M Double Regulating Valves with integral fixed orifice, inclined model
4017 MW	DN 15 - 50	4017-MW Double Regulating Valves with integral fixed orifice for drinking water, inclined model with test points
4217 GMW	DN 15 - 50	4217-GMW Double Regulating Valves for drinking water, screw-down model with test points
4000	DN 15 - 50	Herz -Metering Stations with two test points
4218 GMF	DN 25 - 150	Strömax-GMF, Double Regulating Valves, flanged version with test points
4218 GF	DN 50 - 300	Strömax-GF, Double Regulating Valves, flanged version with test points
4000 + 4117-R	HERZ-Metering Station + STRÖMAX-R- Double Regulating Valve	
4000 + 4217-GR	HERZ-Metering Station + STRÖMAX-GR- Double Regulating Valve	
4000 F + 4218 GMF	HERZ-Stainless Steel Orifice Plates + STRÖMAX-GMF Double Regulating Valves, flanged version with test points	
4000 F + 4218 GF	HERZ-Stainless Steel Orifice Plates + STRÖMAX-GF Double Regulating Valves, flanged version with test points	
4000 F	DN 65 - 300	Herz -Stainless Steel Orifice Plates

☑ Test points

2 test points are located adjacent to the hand wheel at identical angles, sealed by the manufacturer. This arrangement permits optimum access and connection of measuring instruments in any position of installation.

☑ Field of Application

For hydraulic balancing in heating and cooling systems, adjustment of distribution mains, circuits, heat exchangers, heating and cooling registers, etc.

☑ Technical data

Close the valve clockwise

Max. operating temperature 130 °C (up to DN32)

Max. operating temperature 110 °C (from DN40)

Max. operating pressure 16 bar

Water purity in accordance with the OeNORM H5195 and VDI 2035 standards.

Ethylene and propylene glycol can be mixed to a ratio of 25 - 50 vol. [%].

HERZ compression adapters for copper and steel pipes, allowable temperature and pressure ratings according to EN 1254-2 1998 Table 5.

HERZ plastic pipe connections max. operating temperature 95 ° C and max. operating pressure 10 bar, if approved by the pipe manufacturer.

Ammonia contained in hemp can damage brass valve bodies, EPDM gaskets can be affected by Mineral oils lubricants and thus lead to failure of the EPDM seals. Please refer to manufacturers documentation when using ethylene glycol products for frost and corrosion protection.

☑ Plastic Pipe Connection

The circuit control valves R = 1/2" are suitable for systems with plastic pipes. Adapters and plastic pipe unions are connected to the sockets. For models and dimensions consult the HERZ catalogue.

☑ Flow Direction

During installation, take into account the flow direction arrow on the valve body.

☑ Installation Position

The non-rising valve spindle arranged perpendicular to the valve axis guarantees optimum accessibility and optimum valve operation in any installation position.

☑ Presetting

The current position of the flow restriction cone is shown on a clearly visible digital display on the front side of the hand wheel. The desired presetting step can be easily adjusted and secured by means of the covered presetting spindle located inside the valve. The preset circuit control valve can be shut off at any time and/or can be set to any desired position below the fixed presetting. The presetting spindle is covered by the hand wheel fastening screw and thus protected against unauthorized operation.

☑ Preset Sealing

The presetting seal (1 6517 04) is attached above the hand wheel fastening screw to prevent unauthorized operation. If the seal is removed it breaks and cannot be mounted again. Therefore, it can be clearly seen whether tampering with the valve has occurred.

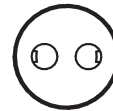

☑ Presetting Marker

The pre-setting marker (1 6517 05) is fastened as a tag above the valve or pipe. The setting of the respective valve is marked by cutting or breaking off the teeth at the figures for full and partial turns.

This permits checking and/or restoration of the original pre-setting made on the occasion of the system set-up after servicing without having to rely on documentation.



☑ STRÖMAX-GR

STRÖMAX-GR valves are of the same mechanical design as STRÖMAX-GM, i.e. the digital presetting step display as well as the presetting procedure are identical. However, STRÖMAX-GR valves are not equipped with measuring valves.

☑ Differential Pressure Measurement - STRÖMAX-GM/GML

The STRÖMAX-GM commissioning valve is equipped with two test points. The differential pressure can be measured using a suitable measuring instrument, which permits calculation of the flow rate as a function of the respective presetting step. The HERZ-Measuring computer (1 8900 05) permits direct flow rate reading (consult the equipment manual).

☑ Presetting

The STRÖMAX-GM/GML/GR commissioning valves are supplied in open position, preset to permit the maximum possible valve lift. The hand wheel mechanism is adjusted in such a way that the digital reading will be 0.0, when the valve is closed.

Presetting Procedure

1. Set to the desired step according to calculation (digital display on the hand wheel).
2. Remove the hand wheel locking screw, do not remove the hand wheel from the valve.
3. Screw the presetting spindle, which is now accessible, in up to the stop.
4. Screw in the hand wheel locking screw again.
5. Seal with presetting seal.
6. Mark the step set at the presetting marker and attach the marker to the valve.

Points 5 and 6 are not necessary for function, but are recommended. When using a differential manometer, setting can be performed only on the basis of the HERZ-setting diagrams. A flowrate for the STRÖMAX-GM valve can only be set without specifying a pre-setting step if a measuring instrument is used. Follow the operating instructions when using a measuring computer.

☑ Digital Display

The factory setting of the digital display is 0.0 when the valve is closed. If the complete hand wheel (rotating grip, figure wheels, base plate) is removed from the valve or if a defective part has to be replaced, proceed as follows to ensure correct digital display reading:

1. Return the complete hand wheel into position and slide it onto the valve until the hexagon at the valve body and the spindle gear interlock.
2. Shut the valve by turning clockwise.
3. If the digital display reads 0.0 in the shut position, the hand wheel has been positioned correctly and can be secured by means of the locking screw. In case of a different reading remove the complete hand wheel.
4. Twist the base plate and rotating grip until the digital display reads 0.0 and then return the complete hand wheel into position without twisting the spindle.
5. Tighten hand wheel locking screw.

Then, the valve can be set to the desired position.

☑ Accessories and Spare Parts

1 6517 04	Pre-setting seal
1 6517 05	Pre-setting marker
1 8900 05	HERZ measuring computer
1 6387 xx	STRÖMAX-GM/GR upper part – refer to the HERZ catalogue for order numbers
1 6517 06	Hand wheel for valve dimension 1/2" – 1 1/2"
1 6517 08	Hand wheel for valve dimension 2" – 3"
1 0284 01	Test points, brass version, blue cap (return)
1 0284 02	Test points, brass version, red cap (supply)
1 0284 03	Test points with capillary connection, brass version, blue cap (return)
1 0284 04	Test points with capillary connection, brass version, red cap (supply)
1 0284 11	Test points, brass version, blue cap (return). Extended model for insulated valves
1 0284 12	Test points, brass version, red cap (supply). Extended model for insulated valves
1 0284 21	Test points with draining function, brass version, blue cap (return), with swivel hose connection
1 0284 22	Test points with draining function, brass version, red cap (supply), with swivel hose connection
1 0284 23	Extended test point, drain function, blue cap
1 0284 24	Extended test point, drain function, red cap

☑ Measuring

Double regulating valves must always be installed with a minimum of 10 pipe diameters of straight pipe, without intrusion, upstream of the valve. Downstream of the valve a minimum of 5 pipe diameters of straight pipe are required.

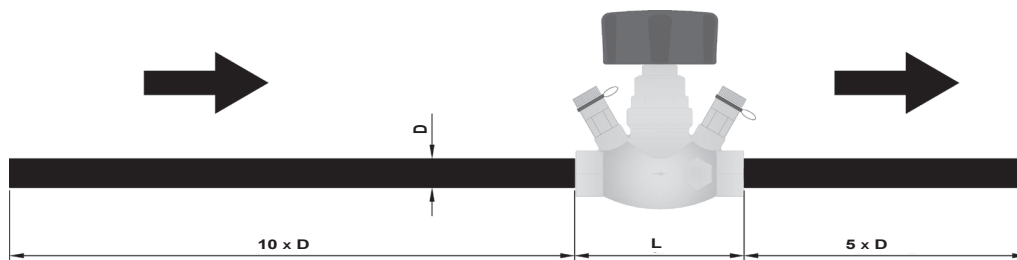

☑ Brass

HERZ uses top-quality brass that responds to the latest European norms EN 12164 and EN 12165. HERZ STRÖMAX commissioning valves are made from brass due to its good strength, excellent corrosion resistance and variety of other properties.

Pursuant to Article 33 of the REACH Regulation (EC No. 1907/2006), we are obliged to point out that the material lead is listed on the SVHC list and that all brass components manufactured in our products exceed 0.1% (w / w) lead (CAS: 7439-92-1 / EINECS: 231-100-4). Since lead is a component part of an alloy, actual exposure is not possible and therefore no additional information on safe use is necessary

☑ Disposal instruction

The disposal of HERZ STRÖMAX commissioning valves must not endanger the health or the environment. National legal regulations for proper disposal of the HERZ STRÖMAX commissioning valves have to be followed.

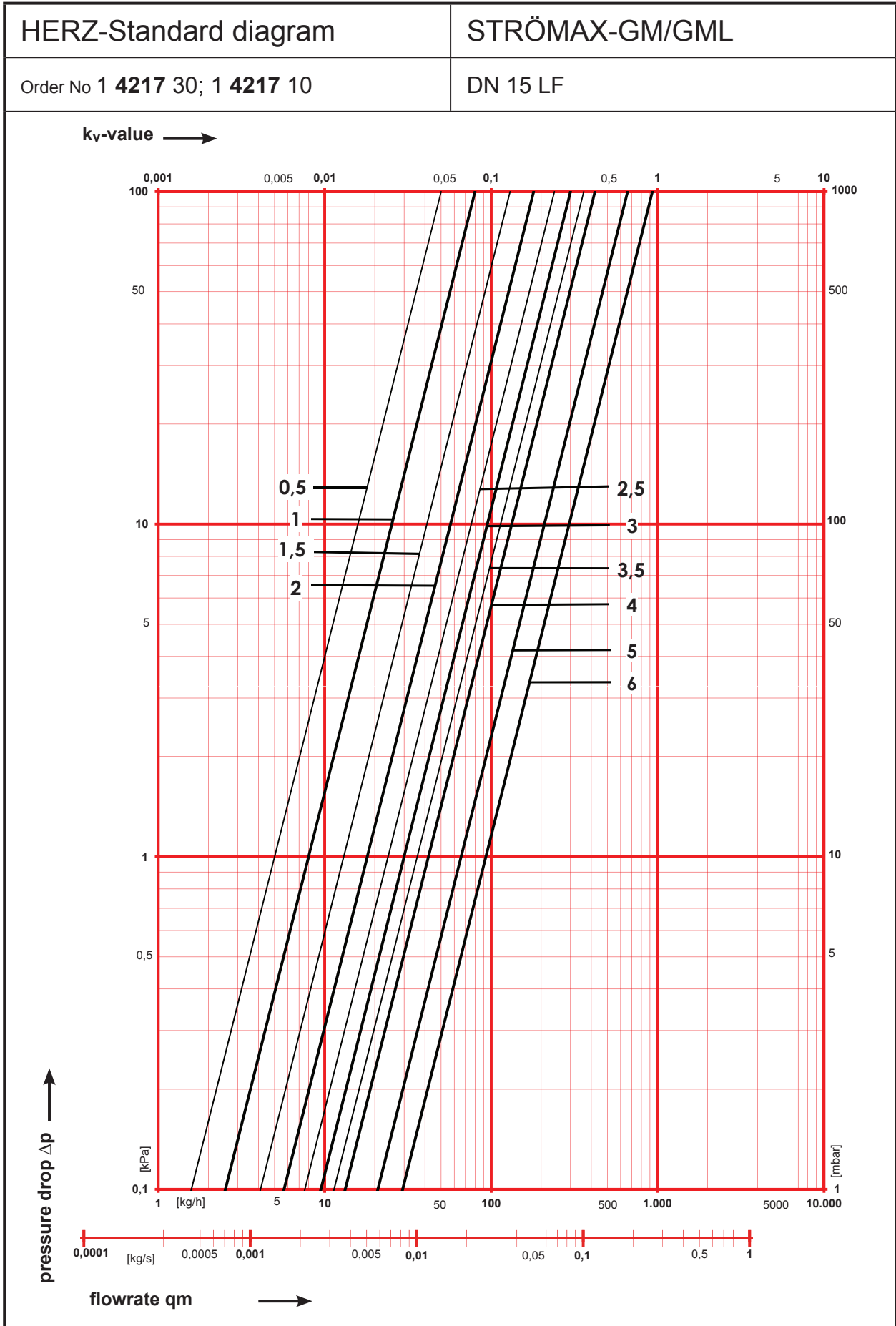

HERZ-Standard diagram	STRÖMAX-GM/GML
-----------------------	----------------

Order No 1 4217 31; 1 4217 19	DN 15 MF
-------------------------------	----------

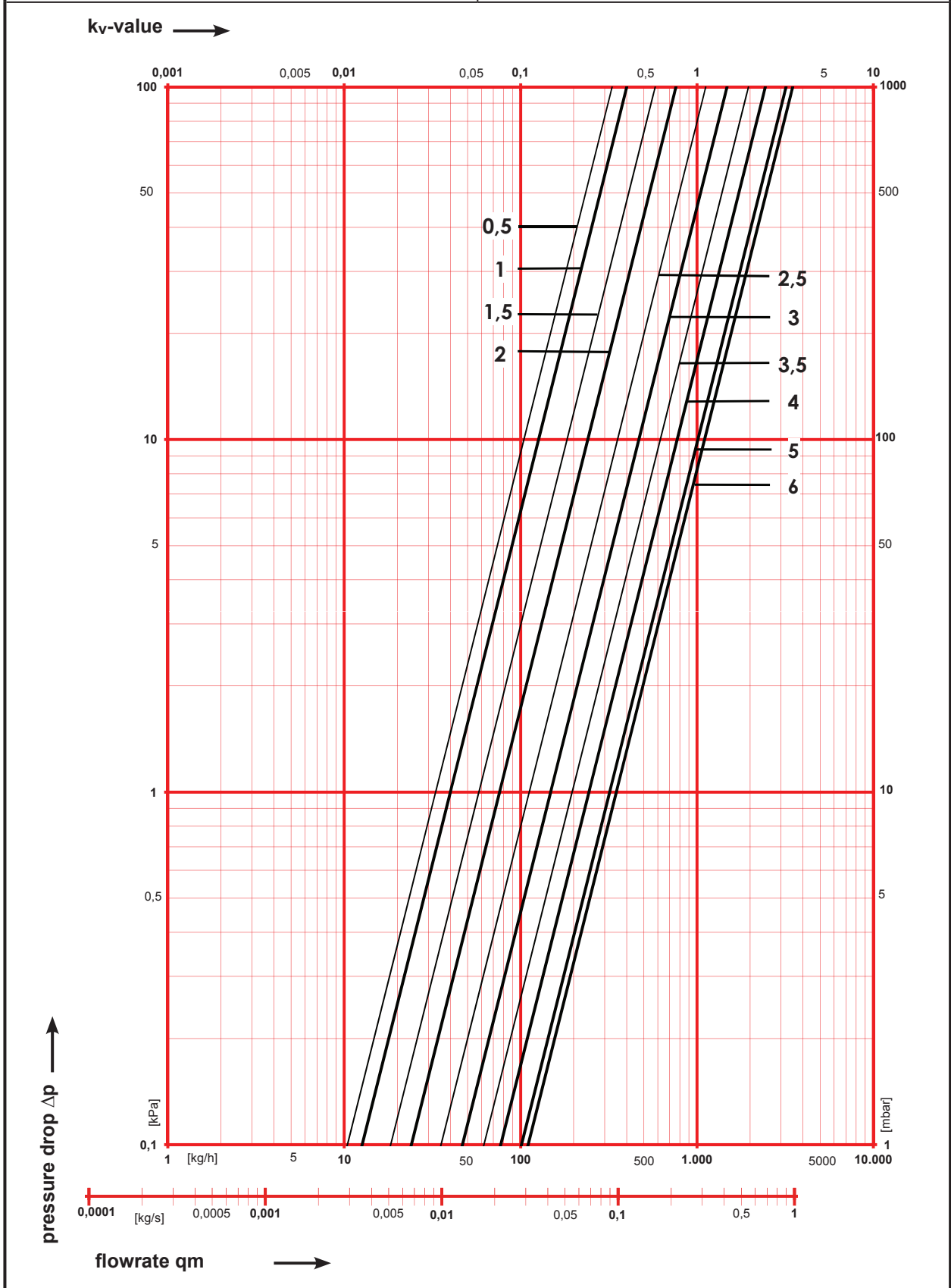

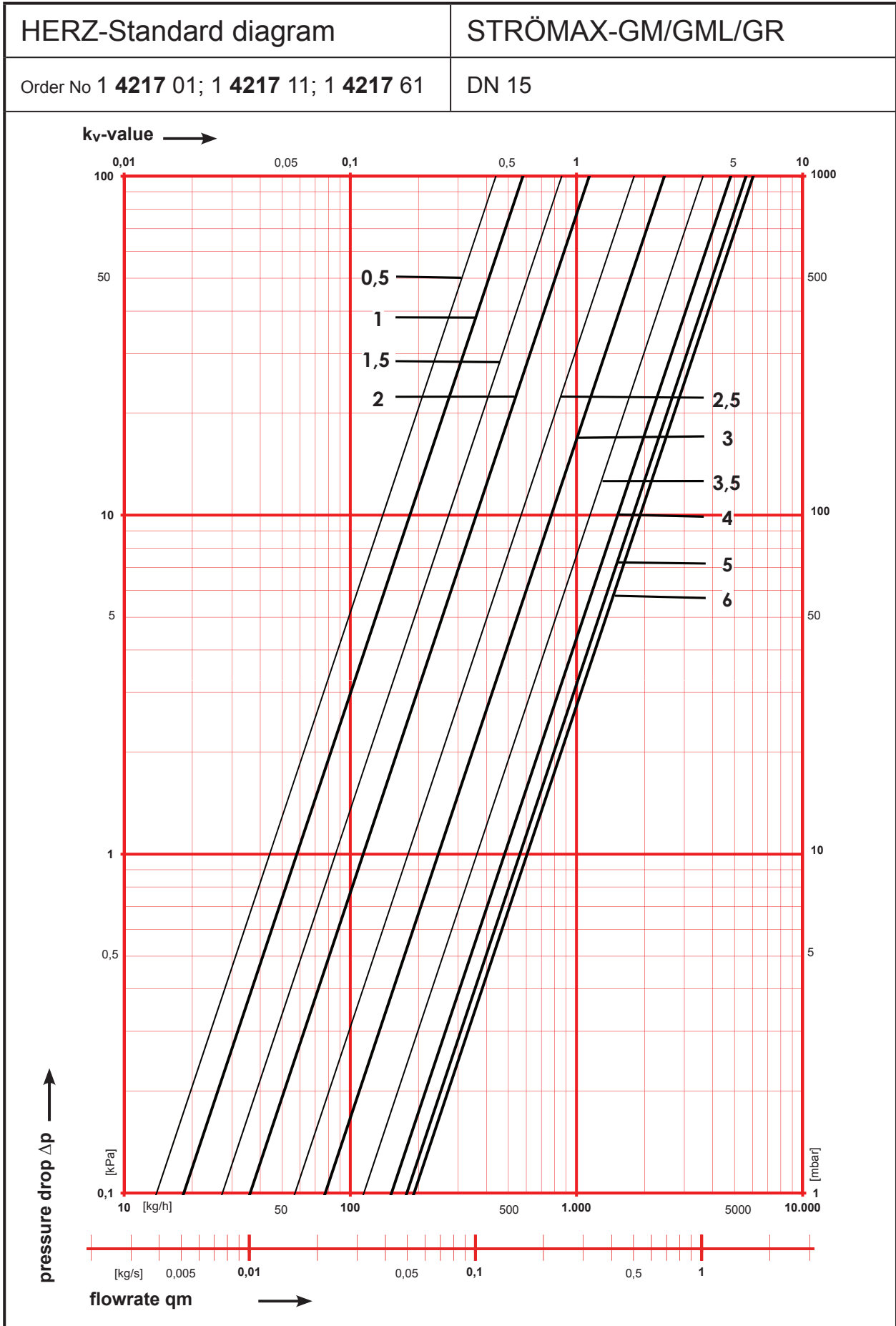

HERZ-Standard diagram	STRÖMAX-GM/GML/GR
Order No 1 4217 32; 1 4217 12 ;1 4217 62	DN 20

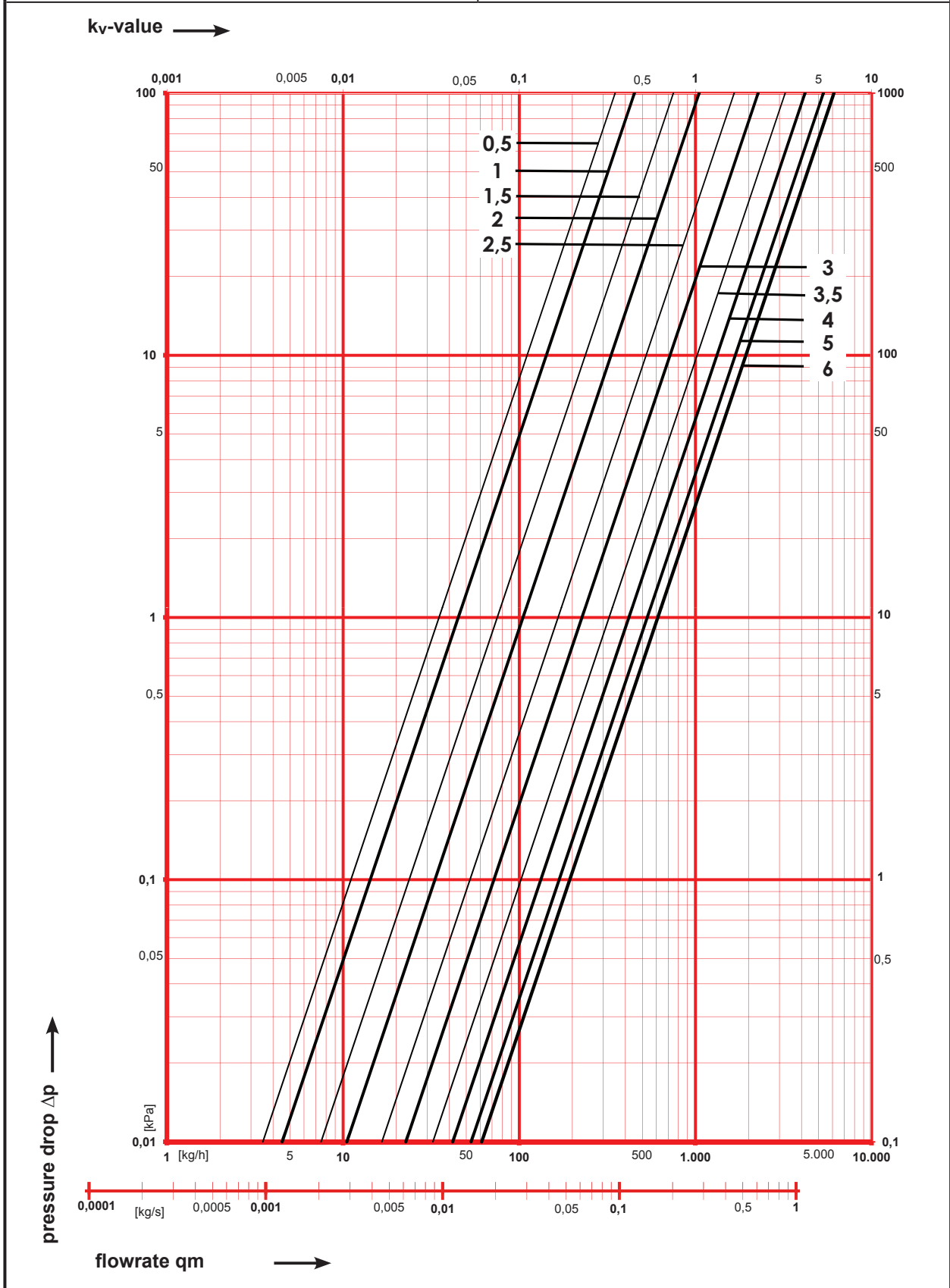

HERZ-Standard diagram	STRÖMAX-GM/GML/GR
Order No 1 4217 33; 1 4217 13; 1 4217 63	DN 25

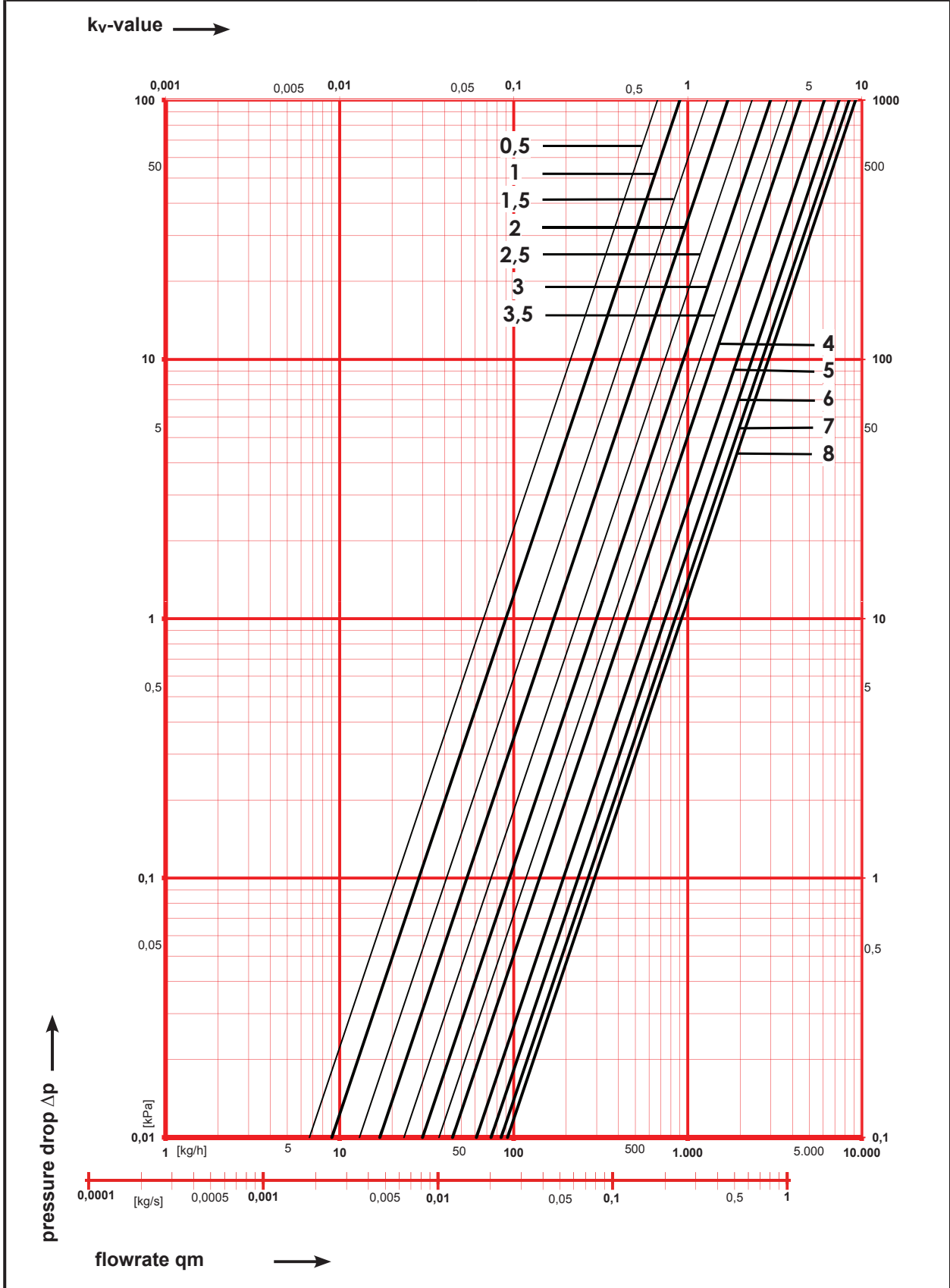

HERZ-Standard diagram	STRÖMAX-GM/GML/GR
-----------------------	-------------------

Order No 1 4217 34; 1 4217 14; 1 4217 64	DN 32
--	-------

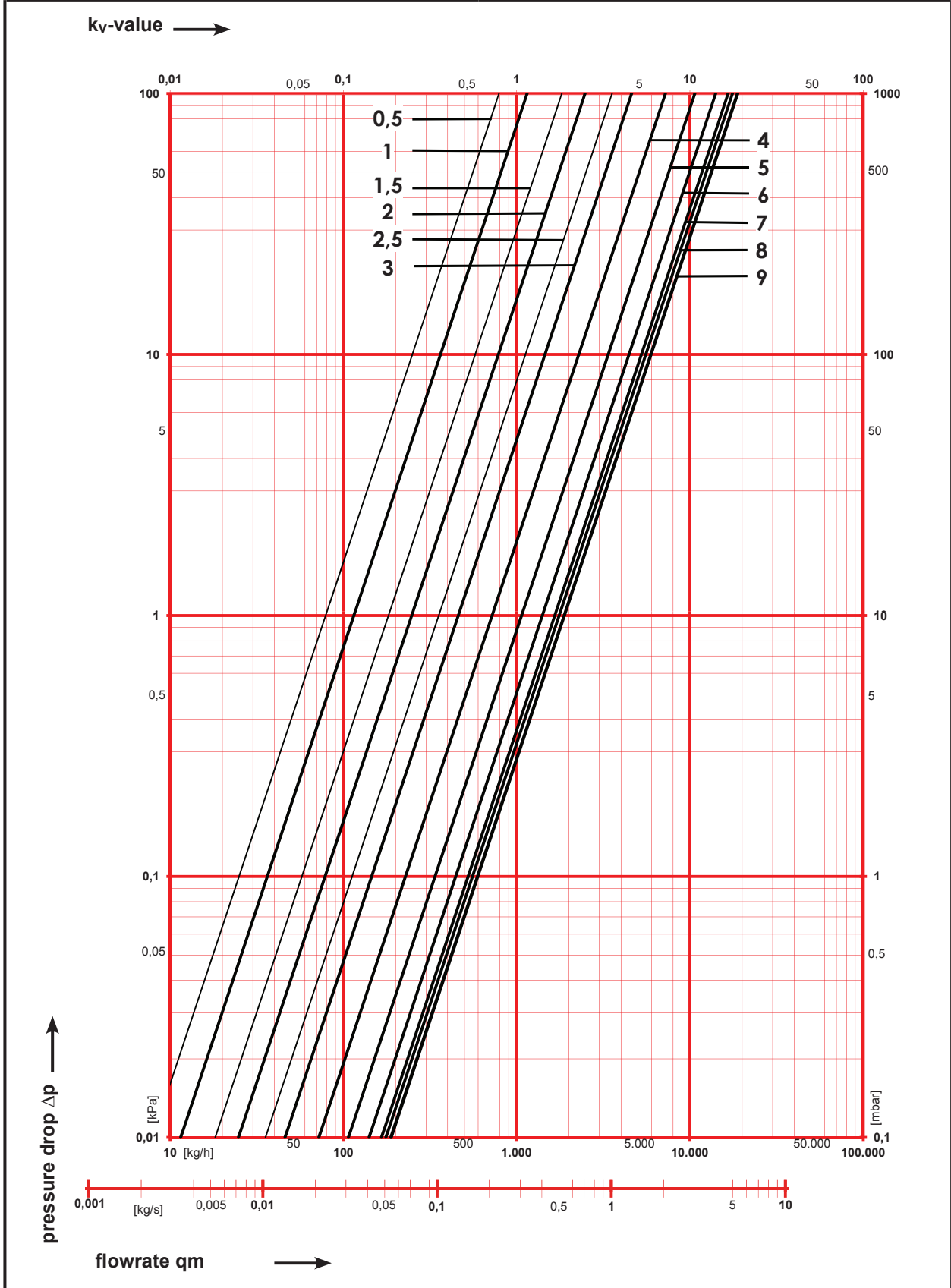

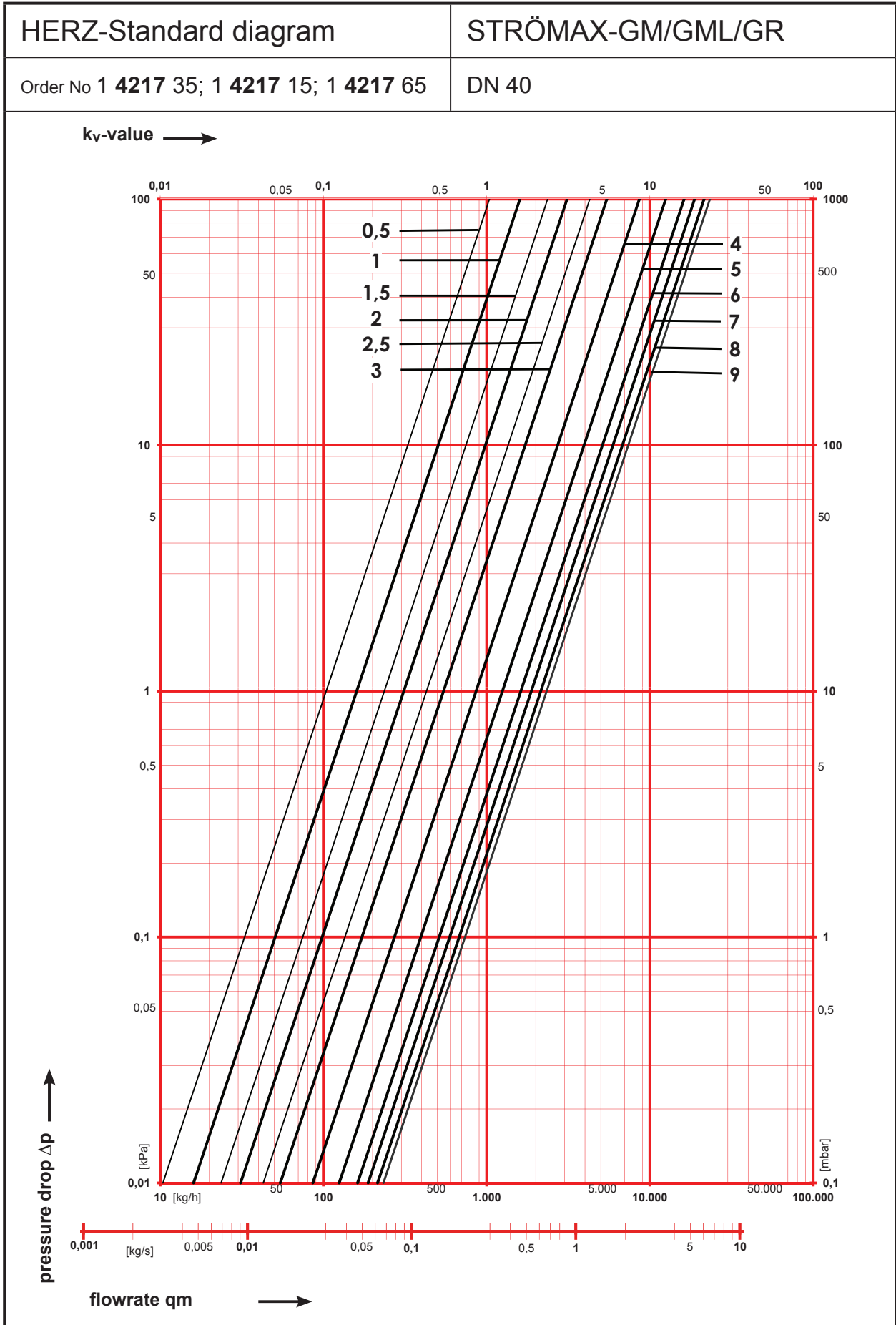

HERZ-Standard diagram	STRÖMAX-GM/GML/GR
-----------------------	-------------------

Order No 1 4217 36; 1 4217 16; 1 4217 66	DN 50
--	-------

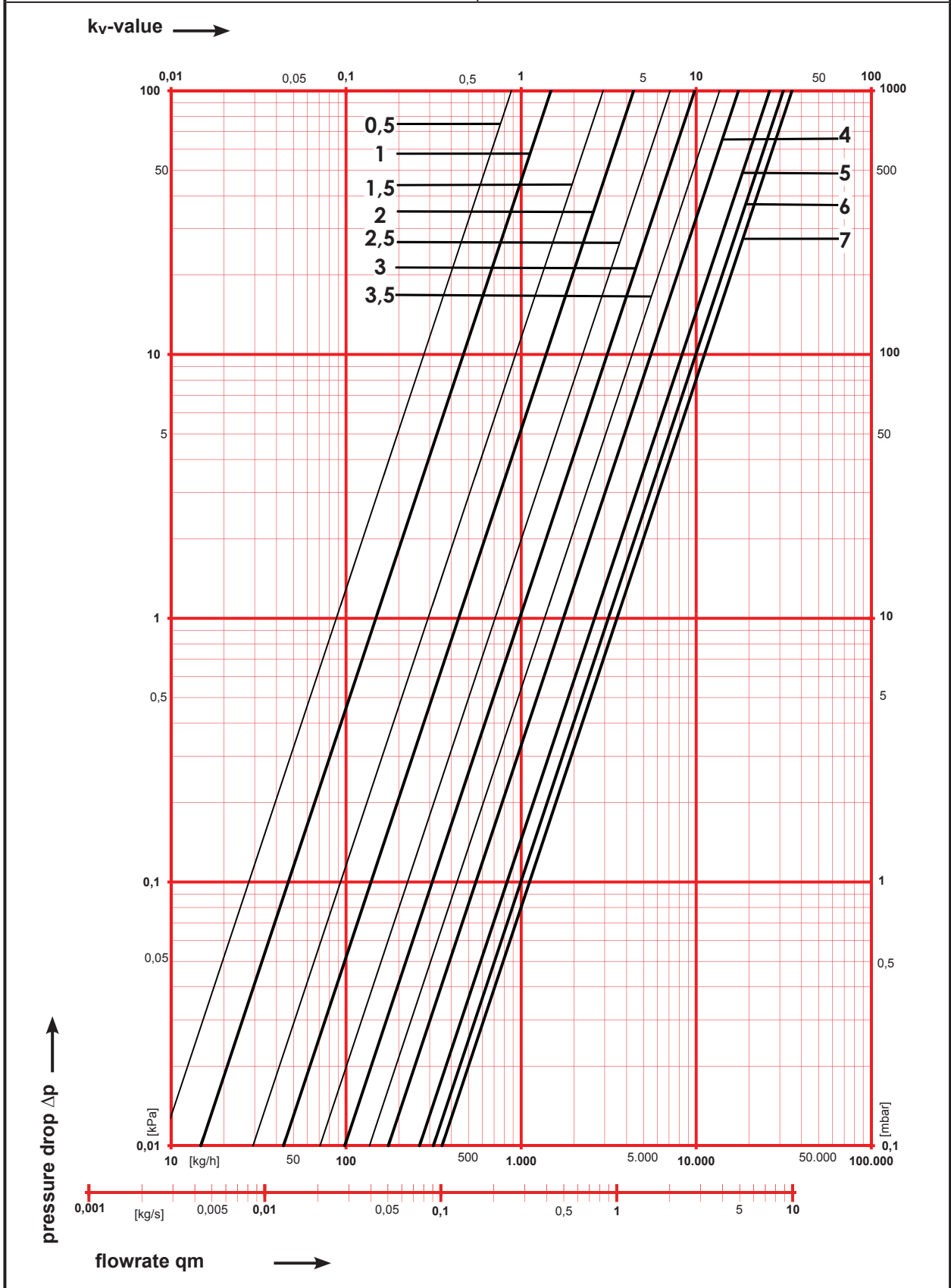

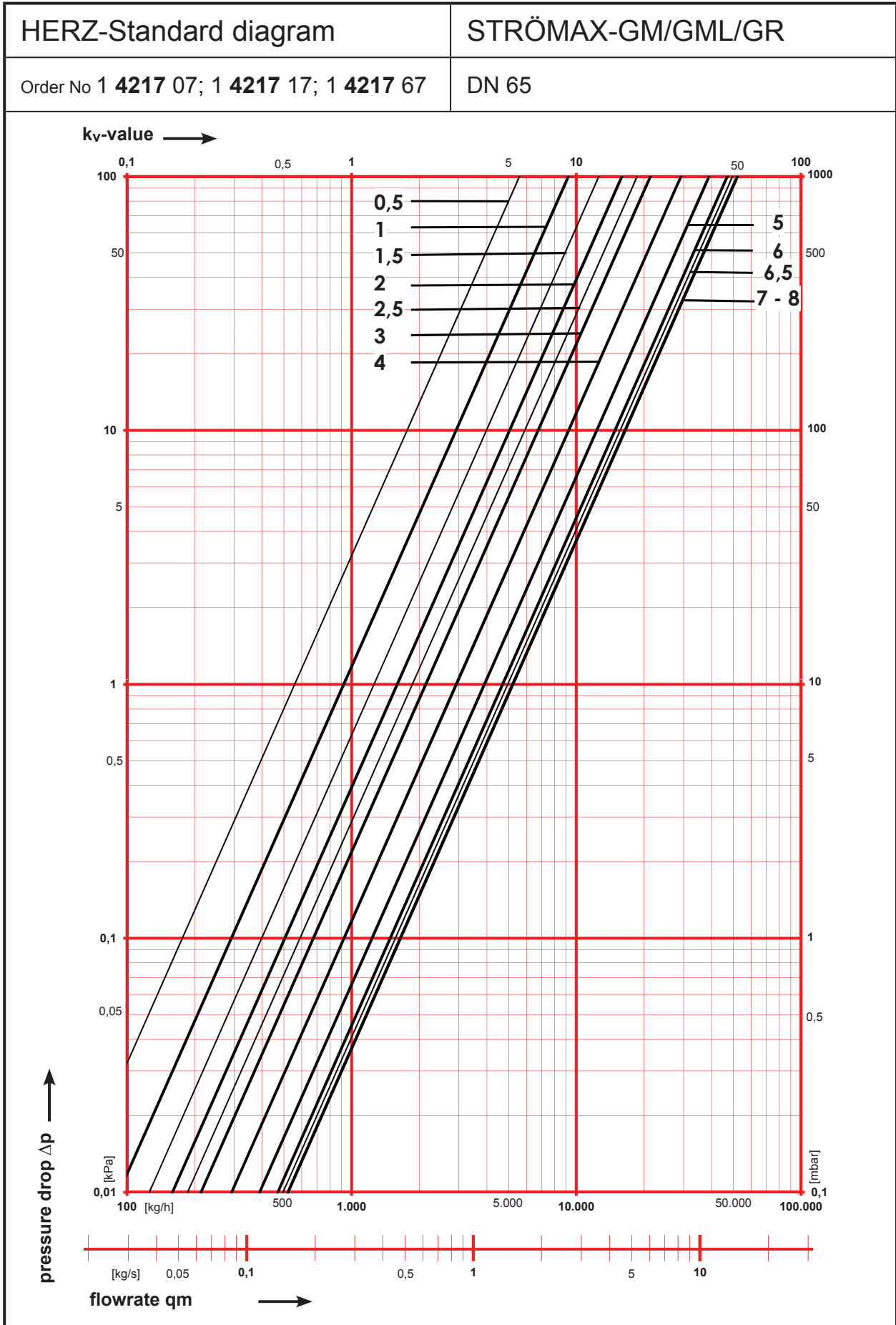

HERZ-Standard diagram	STRÖMAX-GM/GML/GR
Order No 1 4217 08; 1 4217 18; 1 4217 68	DN 80

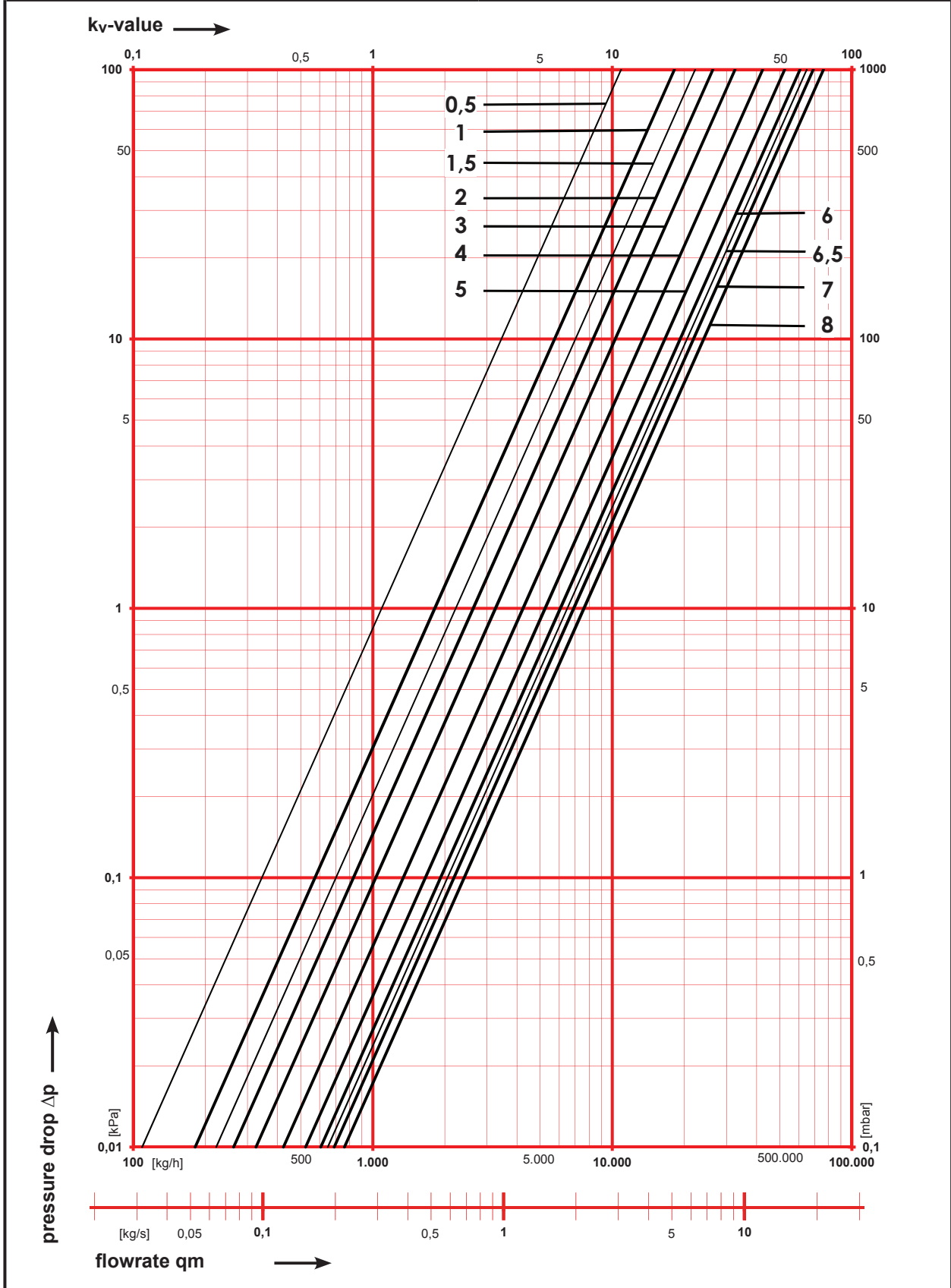

Setting	DN 15LF	DN 15MF	DN 15	DN 20	DN 25	DN 32	DN 40	DN 50	DN 65	DN 80
0,5	0,05	0,33	0,44	0,35	0,67	0,79	1,04	0,88	5,58	10,89
0,6	0,06	0,34	0,47	0,37	0,71	0,86	1,15	1,00	6,31	12,34
0,7	0,06	0,36	0,50	0,39	0,76	0,93	1,26	1,12	7,04	13,79
0,8	0,07	0,37	0,52	0,41	0,81	1,00	1,38	1,24	7,76	15,25
0,9	0,07	0,39	0,55	0,43	0,85	1,08	1,49	1,36	8,49	16,70
1,0	0,08	0,40	0,58	0,45	0,90	1,15	1,60	1,48	9,22	18,15
1,1	0,09	0,44	0,64	0,51	0,98	1,28	1,76	1,77	9,89	18,96
1,2	0,10	0,47	0,69	0,57	1,06	1,41	1,91	2,06	10,57	19,78
1,3	0,11	0,51	0,75	0,63	1,14	1,55	2,06	2,35	11,24	20,59
1,4	0,12	0,54	0,80	0,69	1,22	1,68	2,21	2,65	11,91	21,40
1,5	0,13	0,58	0,86	0,75	1,30	1,82	2,36	2,94	12,58	22,21
1,6	0,14	0,61	0,92	0,81	1,38	1,95	2,51	3,23	13,25	23,02
1,7	0,15	0,65	0,97	0,87	1,46	2,08	2,66	3,52	13,92	23,84
1,8	0,16	0,69	1,03	0,93	1,54	2,22	2,81	3,81	14,60	24,65
1,9	0,17	0,72	1,09	0,99	1,62	2,35	2,96	4,10	15,27	25,46
2,0	0,18	0,76	1,14	1,05	1,70	2,48	3,11	4,39	15,94	26,27
2,1	0,19	0,83	1,28	1,17	1,83	2,70	3,35	4,93	16,48	26,90
2,2	0,20	0,90	1,41	1,30	1,96	2,91	3,58	5,47	17,02	27,53
2,3	0,21	0,97	1,54	1,42	2,08	3,12	3,81	6,02	17,56	28,16
2,4	0,23	1,05	1,67	1,54	2,21	3,33	4,05	6,56	18,10	28,79
2,5	0,24	1,12	1,80	1,66	2,34	3,55	4,28	7,10	18,64	29,42
2,6	0,25	1,19	1,93	1,78	2,47	3,76	4,51	7,64	19,18	30,05
2,7	0,26	1,26	2,06	1,90	2,60	3,97	4,75	8,18	19,72	30,68
2,8	0,27	1,34	2,19	2,03	2,73	4,19	4,98	8,72	20,26	31,30
2,9	0,28	1,41	2,32	2,15	2,86	4,40	5,21	9,27	20,81	31,93
3,0	0,30	1,48	2,45	2,27	2,99	4,61	5,45	9,81	21,35	32,56
3,1	0,31	1,58	2,69	2,46	3,13	4,87	5,76	10,57	22,14	33,55
3,2	0,32	1,67	2,92	2,65	3,28	5,13	6,08	11,33	22,92	34,53
3,3	0,33	1,77	3,16	2,85	3,42	5,39	6,40	12,09	23,71	35,52
3,4	0,35	1,86	3,40	3,04	3,57	5,66	6,72	12,85	24,50	36,50
3,5	0,36	1,96	3,63	3,23	3,72	5,92	7,03	13,61	25,29	37,49
3,6	0,37	2,05	3,87	3,42	3,86	6,18	7,35	14,37	26,08	38,47
3,7	0,39	2,15	4,11	3,61	4,01	6,44	7,67	15,13	26,87	39,46
3,8	0,40	2,25	4,34	3,80	4,16	6,70	7,99	15,89	27,66	40,44
3,9	0,41	2,34	4,58	3,99	4,30	6,96	8,30	16,65	28,44	41,43
4,0	0,42	2,44	4,81	4,19	4,45	7,22	8,62	17,41	29,23	42,41
4,1	0,45	2,51	4,89	4,30	4,61	7,57	9,01	18,29	30,21	43,41
4,2	0,47	2,59	4,98	4,41	4,78	7,91	9,39	19,17	31,18	44,42
4,3	0,49	2,67	5,06	4,53	4,94	8,26	9,78	20,06	32,16	45,42
4,4	0,52	2,74	5,14	4,64	5,11	8,60	10,17	20,94	33,13	46,43
4,5	0,54	2,82	5,22	4,76	5,27	8,95	10,55	21,82	34,11	47,43
4,6	0,56	2,89	5,30	4,87	5,44	9,29	10,94	22,71	35,08	48,44
4,7	0,59	2,97	5,38	4,98	5,60	9,64	11,33	23,59	36,06	49,44
4,8	0,61	3,04	5,46	5,10	5,77	9,99	11,71	24,47	37,03	50,44
4,9	0,63	3,12	5,54	5,21	5,93	10,33	12,10	25,36	38,01	51,45

5,0	0,66	3,20	5,62	5,32	6,10	10,68	12,49	26,24	38,98	52,45
Setting	DN 15LF	DN 15MF	DN 15	DN 20	DN 25	DN 32	DN 40	DN 50	DN 65	DN 80
5,1	0,68	3,23	5,67	5,40	6,23	11,02	12,86	26,76	39,78	53,28
5,2	0,71	3,26	5,71	5,48	6,36	11,36	13,23	27,29	40,57	54,10
5,3	0,74	3,29	5,75	5,56	6,49	11,70	13,60	27,81	41,37	54,93
5,4	0,77	3,32	5,79	5,64	6,62	12,04	13,97	28,33	42,16	55,75
5,5	0,79	3,35	5,84	5,72	6,75	12,38	14,34	28,85	42,95	56,58
5,6	0,82	3,37	5,88	5,80	6,88	12,72	14,71	29,37	43,75	57,40
5,7	0,85	3,40	5,92	5,88	7,01	13,06	15,09	29,90	44,54	58,23
5,8	0,88	3,43	5,97	5,96	7,14	13,40	15,46	30,42	45,34	59,05
5,9	0,91	3,46	6,01	6,03	7,28	13,74	15,83	30,94	46,13	59,88
6,0	0,93	3,49	6,05	6,11	7,41	14,08	16,20	31,46	46,93	60,70
6,1					7,51	14,33	16,46	31,84	47,44	61,54
6,2					7,62	14,58	16,72	32,22	47,96	62,37
6,3					7,72	14,83	16,98	32,60	48,48	63,21
6,4					7,82	15,09	17,24	32,98	48,99	64,05
6,5					7,93	15,34	17,49	33,36	49,51	64,88
6,6					8,03	15,59	17,75	33,74	50,03	65,72
6,7					8,14	15,85	18,01	34,12	50,55	66,55
6,8					8,24	16,10	18,27	34,50	51,06	67,39
6,9					8,35	16,35	18,53	34,88	51,58	68,22
7,0					8,45	16,61	18,79	35,26	52,10	69,06
7,1					8,53	16,71	19,06		52,10	69,76
7,2					8,61	16,81	19,33		52,10	70,47
7,3					8,68	16,91	19,59		52,10	71,17
7,4					8,76	17,01	19,86		52,10	71,87
7,5					8,84	17,11	20,13		52,10	72,58
7,6					8,91	17,21	20,40		52,10	73,28
7,7					8,99	17,30	20,67		52,10	73,99
7,8					9,07	17,40	20,94		52,11	74,69
7,9					9,14	17,50	21,20		52,11	75,40
8,0					9,22	17,60	21,47		52,11	76,10
8,1						17,73	21,65			
8,2						17,85	21,84			
8,3						17,97	22,02			
8,4						18,09	22,20			
8,5						18,21	22,38			
8,6						18,34	22,56			
8,7						18,46	22,74			
8,8						18,58	22,92			
8,9						18,70	23,10			
9,0						18,83	23,29			

Please note: all diagrams are indicative in nature and do not claim to be complete.

All specifications and statements within this document are according to information available at the time of printing and meant for informational purpose only. Herz Armaturen reserves the right to modify and change products as well as its technical specifications and/or its functioning according to technological progress and requirements. It is understood that all images of Herz products are symbolic representations and therefore may visually differ from the actual product. Colours may differ due to printing technology used. In case of any further questions don't hesitate to contact your closest HERZ Branch-office.